



(Please scan this QR Code to view the Prospectus)

Prospectus
100% Book Built Issue
Dated: August 16, 2024
Please read Section 26 and 32 of the
Companies Act, 2013



SUNLITE RECYCLING INDUSTRIES LIMITED
(Formerly known as Sunlite Alucop Private Limited)
CIN: U27200GJ2022PLC134540

REGISTERED OFFICE	CONTACT PERSON	EMAIL AND TELEPHONE	WEBSITE
Survey No. 270A & Plot No. 1, Survey No. 267, Chhatha Mile, Dantali, Vaso, Kheda - 387350, Gujarat, India.	Nikita Sharma Company Secretary & Compliance Officer	E-mail: cs@sunliteindustries.com Tel No: +91-9265111757	www.sunliteindustries.com

PROMOTERS OF THE COMPANY
Nitin Kumar Heda, Prahladrai Ramdayal Heda, Khushboo Manishkumar Heda and Manish Kumar Heda

DETAILS OF THE ISSUE				
TYPE	FRESH ISSUE SIZE	OFS SIZE (BY NO. OF SHARES OR BY AMOUNT IN ₹)	TOTAL ISSUE SIZE	ELIGIBILITY
Fresh Issue	28,80,000 Equity Shares aggregating up to ₹3024.00 lakhs	Nil	₹3024.00 lakhs	This Issue is being made in terms of regulation 229(2) and 253(1) of chapter IX of the SEBI (ICDR) Regulations, 2018 as amended.

DETAILS OF OFFER FOR SALE, SELLING SHAREHOLDERS AND THEIR AVERAGE COST OF ACQUISITION – NOT APPLICABLE AS THE ENTIRE ISSUE CONSTITUTES FRESH ISSUE OF EQUITY SHARES

RISK IN RELATION TO THE FIRST ISSUE

The face value of the Equity Shares is ₹10. The Floor Price, Cap Price and Issue Price determined by our Company, in consultation with the Book Running Lead Manager, on the basis of the assessment of market demand for the Equity Shares by way of the Book Building Process, as stated under “Basis for Issue Price” on page 77 should not be considered to be indicative of the market price of the Equity Shares after the Equity Shares are listed. No assurance can be given regarding an active or sustained trading in the Equity Shares nor regarding the price at which the Equity Shares will be traded after listing.

GENERAL RISKS

Investments in Equity and Equity-related securities involve a degree of risk and investors should not invest any funds in this Issue unless they can afford to take the risk of losing their entire investment. Investors are advised to read the risk factors carefully before taking an investment decision in the Issue. For taking an investment decision, investors must rely on their own examination of our Company and the Issue including the risks involved. The Equity Shares issued in the Issue have not been recommended or approved by the Securities and Exchange Board of India (“SEBI”), nor does SEBI guarantee the accuracy or adequacy of the Prospectus. Specific attention of the investors is invited to the section “Risk Factors” beginning on page 25 of this Prospectus.

ISSUER ABSOLUTE RESPONSIBILITY

Our Company, having made all reasonable inquiries, accepts responsibility for and confirms that this Prospectus contains all information with regard to our Company and the Issue, which is material in the context of the Issue, that the information contained in this Prospectus is true and correct in all material aspects and is not misleading in any material respect, that the opinions and intentions expressed herein are honestly held and that there are no other facts, the omission of which makes this Prospectus as a whole or any of such information or the expression of any such opinions or intentions, misleading in any material respect.

LISTING

The Equity Shares Issued through Prospectus are proposed to be listed on the SME Platform of NSE (“NSE Emerge”). In terms of the Chapter IX of the SEBI (ICDR) Regulations, 2018 as amended from time to time. For the purpose of this Issue, the Designated Stock Exchange will be the National Stock Exchange of India Limited (“NSE”).

BOOK RUNNING LEAD MANAGER TO THE ISSUE

NAME AND LOGO	CONTACT PERSON	EMAIL & TELEPHONE
 HEM SECURITIES LIMITED	Ajay Jain	Email: ib@hemsecurities.com Tel. No.: +91- 22- 4906 0000

REGISTRAR TO THE ISSUE

NAME AND LOGO	CONTACT PERSON	EMAIL & TELEPHONE
 CAMEO CORPORATE SERVICES LIMITED	Ms. K Sreepriya	Email: ipo@cameoindia.com Tel No: +91-44-40020700/28460390

BID/ISSUE PERIOD

ANCHOR PORTION ISSUE OPENED/ CLOSED ON*:	BID/ ISSUE OPENED ON:	BID/ ISSUE CLOSED ON:
FRIDAY, AUGUST 09, 2024	MONDAY, AUGUST 12, 2024	WEDNESDAY, AUGUST 14, 2024

* The Anchor Investor Bid/Issue date was on Friday, August 09, 2024, one Working Day prior to the Bid/Issue Opening Date.



SUNLITE RECYCLING INDUSTRIES LIMITED
(Formerly known as Sunlite Alucop Private Limited)
CIN: U27200GJ2022PLC134540

Our company was originally formed as partnership firm under the Indian Partnership Act, 1932 ("Partnership Act") in the name and style of "M/s. Sunlite Industries, pursuant to a deed of partnership entered between Prahladrai Ramdayal Heda, Nitin Kumar Heda and Khushboo Manishkumar Heda executed on dated September 28, 2017 on the terms and conditions contained in the said partnership deed. Later on, "M/s Sunlite Industries" was thereafter converted from partnership firm to a private limited Company under part I Chapter XXI of Section 366 of the Companies Act, 2013 with the name and style of "Sunlite Alucop Private Limited" and received a certificate of incorporation dated August 04, 2022 issued by the Registrar of Companies, Central Registration Centre bearing Corporate Identification Number U27200GJ2022PTC134540. Further, pursuant to Special Resolution passed by the shareholders at the Extra Ordinary General Meeting held on January 12, 2024, the name of our Company was changed from "Sunlite Alucop Private Limited" to "Sunlite Recycling Industries Private Limited" and a fresh certificate of incorporation consequent upon change of name was issued by the Registrar of Companies, Ahmedabad vide letter dated January 18, 2024. Subsequently, our Company was converted into a Public Limited Company vide Special Resolution passed by the Shareholders at the Extra Ordinary General Meeting, held on February 10, 2024 and consequently the name of our Company was changed from "Sunlite Recycling Industries Private Limited" to "Sunlite Recycling Industries Limited" vide a fresh certificate of incorporation consequent upon conversion from private company to public company dated April 30, 2024 issued by the Registrar of Companies, Central Processing Centre. Our Company's Corporate Identity Number is U27200GJ2022PLC134540. For further details of Incorporation, change of name and registered office of our Company, please refer to chapter titled "History and Corporate Structure" beginning on page 121 of this Prospectus.

Registered Office: Survey No. 270A & Plot No. 1, Survey No. 267, Chhatha Mile, Dantali, Vaso, Kheda -387350, Gujarat, India.

Tel No: +91 9265111757; **E-mail:** cs@sunliteindustries.com; **Website:** www.sunliteindustries.com;

Contact Person: Nikita Sharma, Company Secretary & Compliance Officer

Promoters of our Company: Nitin Kumar Heda, Prahladrai Ramdayal Heda, Khushboo Manishkumar Heda and Manish Kumar Heda

DETAILS OF THE ISSUE

INITIAL PUBLIC OFFER OF 28,80,000 EQUITY SHARES OF FACE VALUE OF ₹ 10/- EACH (THE "EQUITY SHARES") OF SUNLITE RECYCLING INDUSTRIES LIMITED ("OUR COMPANY" OR "THE ISSUER") AT AN ISSUE PRICE OF ₹105 PER EQUITY SHARE (INCLUDING SHARE PREMIUM OF 95 PER EQUITY SHARE) FOR CASH, AGGREGATING UP TO ₹ 3024.00 LAKHS ("PUBLIC ISSUE") OUT OF WHICH 1,48,800 EQUITY SHARES OF FACE VALUE OF ₹10 EACH, AT AN ISSUE PRICE OF ₹105 PER EQUITY SHARE FOR CASH, AGGREGATING ₹156.24 LAKHS WILL BE RESERVED FOR SUBSCRIPTION BY THE MARKET MAKER TO THE ISSUE (THE "MARKET MAKER RESERVATION PORTION"). THE PUBLIC ISSUE LESS MARKET MAKER RESERVATION PORTION I.E. ISSUE OF 27,31,200 EQUITY SHARES OF FACE VALUE OF ₹10 EACH, AT AN ISSUE PRICE OF ₹105 PER EQUITY SHARE FOR CASH, AGGREGATING UPTO ₹2867.76 LAKHS IS HEREIN AFTER REFERRED TO AS THE "NET ISSUE". THE PUBLIC ISSUE AND NET ISSUE WILL CONSTITUTE 26.47% AND 25.10% RESPECTIVELY OF THE POST- ISSUE PAID-UP EQUITY SHARE CAPITAL OF OUR COMPANY.

**Subject to finalization of Basis of Allotment*

THE FACE VALUE OF THE EQUITY SHARES IS ₹10/- EACH. THE ISSUE PRICE IS 10.5 TIMES WITH THE FACE VALUE OF THE EQUITY SHARES. THE ANCHOR INVESTOR ISSUE PRICE IS ₹105 PER EQUITY SHARE. THE PRICE BAND AND THE MINIMUM BID LOT WERE DECIDED BY OUR COMPANY IN CONSULTATION WITH THE BOOK RUNNING LEAD MANAGER ("BRLM") AND WERE ADVERTISED IN ALL EDITIONS OF THE ENGLISH NATIONAL NEWSPAPER, "BUSINESS STANDARD", ALL EDITIONS OF THE HINDI NATIONAL NEWSPAPER, "BUSINESS STANDARD" AND GUJARATI EDITION OF AHMEDABAD EXPRESS, REGIONAL NEWSPAPER (GUJARATI BEING THE REGIONAL LANGUAGE OF KHEDA WHERE OUR REGISTERED OFFICE IS LOCATED), EACH WITH WIDE CIRCULATION, AT LEAST 2 (TWO) WORKING DAYS PRIOR TO THE BID/ ISSUE OPENING DATE AND WERE MADE AVAILABLE TO NATIONAL STOCK EXCHANGE OF INDIA LIMITED ("NSE"), REFERRED TO AS THE "DESIGNATED STOCK EXCHANGE" FOR THE PURPOSE OF UPLOADING ON THEIR WEBSITE IN ACCORDANCE WITH SECURITIES AND EXCHANGE BOARD OF INDIA (ISSUE OF CAPITAL AND DISCLOSURE REQUIREMENTS) REGULATIONS, 2018, AS AMENDED (THE "SEBI (ICDR) REGULATIONS").

The Issue was made through the Book Building Process, in terms of Rule 19(2)(b)(i) of the Securities Contracts (Regulation) Rules, 1957, as amended ("SCRR") read with Regulation 253 of the SEBI ICDR Regulations, as amended, wherein not more than 50% of the Net Issue was available for allocation on a proportionate basis to Qualified Institutional Buyers ("QIBs", the "QIB Portion"), Our Company, in consultation with the Book Running Lead Managers, allocate up to 60% of the QIB Portion to Anchor Investors on a discretionary basis in accordance with the SEBI ICDR Regulations ("Anchor Investor Portion"), Further, not less than 15% of the Net Issue was made available for allocation on a proportionate basis to Non-Institutional Bidders and not less than 35% of the Net Issue was made available for allocation to Retail Individual Bidders in accordance with the SEBI ICDR Regulations, subject to valid Bids being received at or above the Issue Price. All potential Bidders (except Anchor Investors) were required to mandatorily utilize the Application Supported by Blocked Amount ("ASBA") process providing details of their respective ASBA accounts, and UPI ID in case of RIBs using the UPI Mechanism, if applicable, in which the corresponding Bid Amounts will be blocked by the SCSBs or by the Sponsor Bank under the UPI Mechanism, as the case may be, to the extent of respective Bid Amounts. Anchor Investors were not permitted to participate in the Issue through the ASBA process. For details, see "Issue Procedure" beginning on page 227 of this Prospectus.

ELIGIBLE INVESTORS

For details in relation to Eligible Investors, please refer to section titled "Issue Procedure" beginning on page 227 of this Prospectus.

RISK IN RELATION TO THE FIRST ISSUE

The face value of the Equity Shares is ₹10. The Floor Price, Cap Price and Issue Price determined by our Company, in consultation with the Book Running Lead Managers, on the basis of the assessment of market demand for the Equity Shares by way of the Book Building Process, as stated under "Basis for Issue Price" on page 77 should not be considered to be indicative of the market price of the Equity Shares after the Equity Shares are listed. No assurance can be given regarding an active or sustained trading in the Equity Shares nor regarding the price at which the Equity Shares will be traded after listing.

GENERAL RISKS

Investments in Equity and Equity-related securities involve a degree of risk and investors should not invest any funds in this Issue unless they can afford to take the risk of losing their entire investment. Investors are advised to read the risk factors carefully before taking an investment decision in the Issue. For taking an investment decision, investors must rely on their own examination of our Company and the Issue including the risks involved. The Equity Shares issued in the Issue have not been recommended or approved by the Securities and Exchange Board of India ("SEBI"), nor does SEBI guarantee the accuracy or adequacy of the Prospectus. Specific attention of the investors is invited to the section "Risk Factors" beginning on page 25 of this Prospectus.

ISSUER ABSOLUTE RESPONSIBILITY



The Company, having made all reasonable inquiries, accepts responsibility for and confirms that this Prospectus contains all information with regard to the Company and the Issue, which is material in the context of the Issue, that the information contained in this Prospectus is true and correct in all material aspects and is not misleading in any material respect, that the opinions and intentions expressed herein are honestly held and that there are no other facts, the omission of which makes this Prospectus as a whole or any of such information or the expression of any such opinions or intentions, misleading in any material respect.

LISTING

The Equity Shares Issued through Prospectus are proposed to be listed on the SME Platform of NSE ("NSE Emerge"). In terms of the Chapter IX of the SEBI (ICDR) Regulations, 2018 as amended from time to time, our Company has received "in-principle" approval letter dated July 29, 2024 from National Stock Exchange of India Limited ("NSE") for using its name in the Issue Document for listing of our shares on the SME Platform of NSE ("NSE Emerge"). For the purpose of this Issue, the Designated Stock Exchange will be the National Stock Exchange of India Limited ("NSE").

BOOK RUNNING LEAD MANAGER TO THE ISSUE

REGISTRAR TO THE ISSUE

	
<p>HEM SECURITIES LIMITED Address: 904, A Wing, Naman Midtown, Senapati Bapat Marg, Elphinstone Road, Lower Parel, Mumbai-400013, Maharashtra, India. Tel. No.: +91- 22- 4906 0000; Email: ib@hemsecurities.com Investor Grievance Email: redressal@hemsecurities.com Website: www.hemsecurities.com Contact Person: Ajay Jain SEBI Registration Number: INM000010981 CIN: U67120RJ1995PLC010390</p>	<p>CAMEO CORPORATE SERVICES LIMITED Address: "Subramanian Building", No. 1, Club House Road, Chennai-600002, Tamil Nadu, India. Tel No.: +91-44-40020700/28460390 Email: ipo@cameoindia.com Website: www.cameoindia.com Investor Grievance Email: investor@cameoindia.com Contact Person: Ms. K Sreepriya Designation: Vice President & Company Secretary SEBI Registration Number: INR000003753 CIN: U67120TN1998PLC041613</p>

BID/ISSUE PERIOD

ANCHOR PORTION ISSUE OPENED/CLOSED ON*: FRIDAY, AUGUST 09, 2024	BID/ISSUE OPENED ON: MONDAY, AUGUST 12, 2024	BID/ISSUE CLOSED ON: WEDNESDAY, AUGUST 14, 2024
--	---	--

*The Anchor Investor Bid/Issue date was on Friday, August 09, 2024, one Working Day prior to the Bid/Issue Opening Date.

TABLE OF CONTENTS

SECTION	CONTENTS	PAGE NO.
I.	GENERAL	
	DEFINITIONS AND ABBREVIATIONS	1
	CERTAIN CONVENTIONS, USE OF FINANCIAL INFORMATION AND MARKET DATA AND CURRENCY OF FINANCIAL PRESENTATION	16
	FORWARD LOOKING STATEMENTS	18
II.	SUMMARY OF PROSPECTUS	19
III.	RISK FACTORS	25
IV.	INTRODUCTION	
	THE ISSUE	45
	SUMMARY OF RESTATED FINANCIAL STATEMENTS	47
	GENERAL INFORMATION	50
	CAPITAL STRUCTURE	59
	OBJECTS OF THE ISSUE	70
	BASIS FOR ISSUE PRICE	77
	STATEMENT OF SPECIAL TAX BENEFITS	83
V.	ABOUT THE COMPANY	
	INDUSTRY OVERVIEW	86
	OUR BUSINESS	98
	KEY REGULATIONS AND POLICIES	110
	HISTORY AND CORPORATE STRUCTURE	121
	OUR MANAGEMENT	125
	OUR PROMOTER & PROMOTER GROUP	138
	DIVIDEND POLICY	143
VI.	FINANCIAL INFORMATION OF THE COMPANY	
	RESTATED FINANCIAL STATEMENTS	144
	OTHER FINANCIAL INFORMATION	181
	STATEMENT OF FINANCIAL INDEBTEDNESS	182
	MANAGEMENT'S DISCUSSION AND ANALYSIS OF FINANCIAL CONDITIONS AND RESULTS OF OPERATIONS	185
	CAPITALISATION STATEMENT	194
VII.	LEGAL AND OTHER INFORMATION	
	OUTSTANDING LITIGATIONS AND MATERIAL DEVELOPMENTS	195
	GOVERNMENT AND OTHER APPROVALS	199
	OUR GROUP COMPANY	204
	OTHER REGULATORY AND STATUTORY DISCLOSURES	206
VIII.	ISSUE RELATED INFORMATION	
	TERMS OF THE ISSUE	218
	ISSUE STRUCTURE	224
	ISSUE PROCEDURE	227
	RESTRICTIONS ON FOREIGN OWNERSHIP OF INDIAN SECURITIES	247
IX.	MAIN PROVISIONS OF THE ARTICLES OF ASSOCIATION OF OUR COMPANY	250
X.	OTHER INFORMATION	
	MATERIAL CONTRACTS AND DOCUMENTS FOR INSPECTION	263
	DECLARATION	264

SECTION I – GENERAL**DEFINITIONS AND ABBREVIATIONS**

This Prospectus uses certain definitions and abbreviations which, unless the context otherwise indicates or implies, shall have the meaning as provided below. References to any legislation, act, regulation, rule, guideline, policy, circular, notification, clarification, direction or policies shall be to such legislation, act, regulation, rule, guideline, policy, circular, notification or clarifications, modifications, replacements or reenactments thereto, as amended, from time to time and any reference to a statutory provision shall include any subordinate legislation made from time to time under that provision. In case of any inconsistency between the definitions given below and the definitions contained in the General Information Document (as defined below), the definitions given below shall prevail.

The words and expressions used in this Prospectus but not defined herein, shall have, to the extent applicable the meaning ascribed to such terms under the Companies Act, 2013, the SEBI (ICDR) Regulations, 2018, the Securities Contracts Regulation Act, 1956 (“SCRA”), the Depositories Act or the rules and regulations made there under.

Notwithstanding the foregoing, terms used in of the sections “Statement of Special Tax Benefits”, “Financial Information of the Company” and “Main Provisions of the Articles of Association of our Company” on page 83, 144 and 250 respectively, shall have the meaning ascribed to such terms in such sections.

General Terms

Terms	Description
“SRIL”, “the Company”, “our Company”, “Issuer” and “Sunlite Recycling Industries Limited”	Sunlite Recycling Industries Limited, a public limited Company incorporated under the Companies Act, 2013 and having its Registered office at Survey No. 270A & Plot No. 1 Survey No. 267, Chhatha Mile, Dantali, Vaso, Kheda -387350, Gujarat, India.
“we”, “us” and “our”	Unless the context otherwise indicates or implies, refers to our Company.
“you”, “your” or “yours”	Prospective investors in this Issue

Company related and Conventional terms

Term	Description
AOA/ Articles/ Articles of Association	Unless the context otherwise requires, refers to the Articles of Association of our Company, as amended, from time to time
Audit Committee	The Committee of the Board of Directors constituted as the Company’s Audit Committee in accordance with Section 177 of the Companies Act, 2013 as described in the chapter titled “ Our Management ” beginning on page 125 of this Prospectus.
Auditors/ Statutory Auditors	The Statutory Auditors of our Company, being M/s. Abhishek Kumar & Associates, (Firm Registration No. as 130052W).
Bankers to our Company	Axis Bank Limited & HDFC Bank Limited
Board of Directors/ the Board/ our Board	The Board of Directors of our Company, including all duly constituted Committees thereof.
Chief Financial Officer/ CFO	The Chief Financial Officer of our Company being Manish Kumar Heda.
Companies Act/ Act	The Companies Act, 2013 and amendments thereto and erstwhile Companies Act 1956 as applicable
Company Secretary and Compliance Officer	The Company Secretary & Compliance Officer of our Company being Nikita Sharma (M. No.: A50255)
Depositories	National Securities Depository Limited (NSDL) and Central Depository Services (India) Limited (CDSL).
Depositories Act	The Depositories Act, 1996, as amended from time to time.
Director(s) / our Directors	The Director(s) of our Company, unless otherwise specified
DP/ Depository Participant	A depository participant as defined under the Depositories Act
DP ID	Depository’s Participant’s Identity Number
Equity Shareholders/ Shareholders	Persons/ Entities holding Equity Shares of our Company
Equity Shares	Equity Shares of the Company of face value of ₹10/- each unless otherwise specified in the context thereof.
Executive Directors	Executive Directors are the Managing Director & Whole-time Directors of our Company.

Term	Description
Fugitive economic offender	Shall mean an individual who is declared a fugitive economic offender under section 12 of the Fugitive Economic Offenders Act, 2018 (17 of 2018)
Group Companies/ Group Company	Our group companies identified in accordance with SEBI (ICDR) Regulations and in accordance with our Materiality Policy. For details, see section titled “Our Group Companies” on page 204 of this Prospectus.
IBC	The Insolvency and Bankruptcy Code 2016
Independent Director	An Independent Director as defined under Section 2(47) of the Companies Act, 2013 and as defined under the Listing Regulations. For details of our Independent Directors, see “Our Management” on page 125 of this Prospectus.
Indian GAAP	Generally Accepted Accounting Principles in India
ISIN	International Securities Identification Number. In this case being INE0U2N01013.
Key Management Personnel/ KMP	Key Management Personnel of our Company in terms of Regulation 2(1)(bb) of the SEBI Regulations and the Companies Act, 2013. For details, see section titled “Our Management” on page 125 of this Prospectus.
LLP	Limited Liability Partnership
MOA/ Memorandum/ Memorandum of Association	Memorandum of Association of Sunlite Recycling Industries Limited as amended from time to time.
MD or Managing Director	The Managing Director of our Company, Nitin Kumar Heda.
Marketing Office	The Marketing office of the company is situated at Office No. 905, 9th floor, Millennium Empire, Sector 15, Panvel, Navi Mumbai – 410210, Maharashtra, India.
Materiality Policy	The policy adopted by the Board in its meeting dated May 08, 2024 for identification of (a) material outstanding litigation proceedings involving our Company and Directors (b) Group Companies; and (c) outstanding dues to material creditors by our Company, in accordance with the disclosure requirements under the SEBI (ICDR) Regulations, 2018 as amended from time to time.
Non-Executive Directors/ Nominee Directors	Non-executive directors on our Board. For details, see section titled “Our Management” on page 125 of this Prospectus
Nomination and Remuneration Committee	The nomination and remuneration committee of our Board constituted in accordance with Section 178 of the Companies Act, 2013 as described in the chapter titled “Our Management” beginning on page 125 of this Prospectus
NRIs / Non-Resident Indians	A person resident outside India, as defined under Foreign Exchange Management Act, 1999 and who is a citizen of India or a Person of Indian Origin under Foreign Exchange Management (Transfer or Issue of Security by a Person Resident Outside India) Regulations, 2000.
Promoter(s)	Shall mean Promoters of our Company i.e. Nitin Kumar Heda, Prahladrai Ramdayal Heda, Khushboo Manishkumar Heda and Manish Kumar Heda. For further details, please refer to section titled “Our Promoter & Promoter Group” beginning on page 138 of this Prospectus.
Promoter Group	The persons and entities constituting the promoter group of our Company in terms of Regulation 2(1) (pp) of the SEBI (ICDR) Regulations, 2018 as enlisted in the section “Our Promoter and Promoter Group” beginning on page 138 of this Prospectus.
Person or Persons	Any individual, sole proprietorship, unincorporated association, unincorporated organization, body corporate, corporation, company, partnership, limited liability company, joint venture, or trust or any other entity or organization validly constituted and/or incorporated in the jurisdiction in which it exists and operates, as the context requires.
RBI Act	The Reserve Bank of India Act, 1934 as amended from time to time.
Registered Office & Manufacturing Unit	The Registered Office of our Company situated at Survey No. 270A & Plot No. 1 Survey No. 267, Chhatha Mile, Dantali, Vaso, Kheda -387350, Gujarat, India.
Reserve Bank of India/ RBI	Reserve Bank of India constituted under the RBI Act.
Restated Financial Information/ Statements	The Restated Financial statements of our Company comprising of the Restated Statement of Assets and Liabilities as at March 31 2024, March 31, 2023 and March 31, 2022 and the Restated Statements of Profit and Loss and Cash Flows Statements for the Fiscals ended as at March 31 2024, March 31, 2023 and March 31, 2022 of our Company prepared in accordance with Indian GAAP and the Companies Act and restated in accordance with the SEBI (ICDR) Regulations, 2018 and the Revised Guidance Note on Reports in Company Prospectuses (Revised 2019) issued by the ICAI, together with the schedules, notes and annexure thereto. For details, please refer section titled “Financial Information of the Company” on page 144 of this Prospectus.

Term	Description
RoC/ Registrar of Companies	Unless specified otherwise refers to RoC Bhavan, Opp Rupal Park Society, Behind Ankur Bus Stop, Naranpura, Ahmedabad-380013, Gujarat, India.
SEBI Act/ SEBI	Securities and Exchange Board of India Act, 1992, as amended from time to time.
SEBI (ICDR) Regulations /ICDR Regulation/ Regulation	SEBI (Issue of Capital and Disclosure Requirements) Regulations, 2018 issued by SEBI on September 11, 2018, as amended, including instructions and clarifications issued by SEBI from time to time.
SEBI (Venture Capital) Regulations	Securities Exchange Board of India (Venture Capital) Regulations, 2000 as amended from time to time.
SEBI AIF Regulations	Securities and Exchange Board of India (Alternative Investments Funds) Regulations, 2012, as amended.
SEBI FII Regulations	Securities and Exchange Board of India (Foreign Institutional Investors) Regulations, 1995, as amended from time to time.
SEBI FPI Regulations	Securities and Exchange Board of India (Foreign Portfolio Investors) Regulations, 2019, as amended from time to time.
SEBI FVCI Regulations	Securities and Exchange Board of India (Foreign Venture Capital Investor) Regulations, 2000, as amended from time to time.
SEBI PIT Regulations	The Securities and Exchange Board of India (Prohibition of Insider Trading) Regulations, 2015 as amended, including instructions, notifications and clarifications issued by SEBI from time to time.
SEBI SBEB Regulations	Securities and Exchange Board of India (Share Based Employee Benefits and Sweat Equity) Regulations, 2021
SEBI Listing Regulations, 2015/ SEBI Listing Regulations/ Listing Regulations/ SEBI (LODR)	The Securities and Exchange Board of India (Listing Obligation and Disclosure Requirements) Regulations, 2015 as amended, including instructions and clarifications issued by SEBI from time to time.
SEBI Takeover Regulations or SEBI (SAST) Regulations/ SEBI Takeover Regulations/ Takeover Regulations/ Takeover Code	Securities and Exchange Board of India (Substantial Acquisition of Shares and Takeover) Regulations, 2011, as amended from time to time.
SEBI (PFUTP) Regulations/ PFUTP Regulations	Securities and Exchange Board of India (Prohibition of Fraudulent and Unfair Trade Practices relating to Securities Markets) Regulations, 2003
Stakeholders' Relationship Committee	Stakeholders' relationship committee of our Company constituted in accordance with Section 178 of the Companies Act, 2013 and as described in the chapter titled "Our Management" beginning on page 125 of this Prospectus.
Stock Exchange	Unless the context requires otherwise, refers to, National Stock Exchange of India Limited
Shareholders	Shareholders of our Company from time to time.
Our Subsidiary Company/ Subsidiaries	The Company does not have any subsidiaris as on the date of this Prospectus.
Sub- Account	Sub- accounts registered with SEBI under the Securities and Exchange Board of India (Foreign Institutional Investor) Regulations, 1995, other than sub-accounts which are foreign corporate or foreign individuals.
Subscriber to MOA	Initial Subscribers to MOA being Nitin Kumar Heda, Prahladrai Ramdayal Heda and Khushboo Manishkumar Heda.

Issue Related Terms

Terms	Description
Applicant	Any prospective investor who makes an application for Equity Shares in terms of this Prospectus
Abridged Prospectus	Abridged prospectus means a memorandum containing such salient features of a prospectus as may be specified by SEBI in this behalf.
Acknowledgement Slip	The slip or document issued by the Designated Intermediary to a bidders as proof of registration of the Application.
Allotment/ Allot/ Allotted	Unless the context otherwise requires, means the allotment of Equity Shares, pursuant to the Issue to the successful bidders.
Allotment Advice	A note or advice or intimation of Allotment sent to the successful Bidders who have been or are to be Allotted the Equity Shares after the Basis of Allotment has been approved by the Designated Stock Exchange.

Terms	Description
Allottee (s)	A successful bidders to whom the Equity Shares are allotted.
Anchor Investor(s)	A Qualified Institutional Buyer, applied under the Anchor Investor Portion in accordance with the requirements specified in the SEBI (ICDR) Regulations and the Prospectus and who has Bid for an amount of at least ₹ 200 lakhs.
Anchor Investor Allocation Price	Rs. 105/- per equity share i.e. the price at which Equity Shares were made available for allocation to the Anchor Investors in terms of the Prospectus and the Prospectus, which was decided by our Company in consultation with the Book Running Lead Managers during the Anchor Investor Bid/ Issue Period.
Anchor Investor Application Form	The application form used by an Anchor Investor to make a Bid in the Anchor Investor Portion and which was be considered as an application for Allotment in terms of the Red Herring Prospectus and Prospectus
Anchor Investor Bid/ Issue Period	August 09, 2024 one Working Day prior to the Bid/ Issue Opening Date, on which Bids by Anchor Investors was submitted and allocation to the Anchor Investors was completed
Anchor Investor Issue Price	Rs. 105/- per equity share i.e. the final price at which the Equity Shares were Allotted to the Anchor Investors in terms of the Red Herring Prospectus and the Prospectus.
Anchor Investor Portion	Up to 60% of the QIB Portion consisting 13,64,400* Equity shares which were allocated by our Company, in consultation with the Book Running Lead Managers, to the Anchor Investors on a discretionary basis in accordance with the SEBI (ICDR) Regulations. <i>*Subject to finalization of the Basis of Allotment</i>
Application Supported by Block Amount (ASBA)	An application, whether physical or electronic, used by ASBA Bidders, to make a Bid and authorising an SCSB to block the Bid Amount in the ASBA Account and include applications made by RIIs using the UPI Mechanism where the Bid amounts were blocked by the SCSB upon acceptance of UPI Mandate Request by the UPI Bidders using the UPI Mechanism.
ASBA Account	Account maintained by the ASBA Bidders with an SCSB in which funds were blocked by such SCSB to the extent of appropriate bid amount in relation to a Bid by an ASBA Bidder
ASBA Application Location(s)/ Specified Cities	Locations at which ASBA Applications can be uploaded by the SCSBs, namely Mumbai, New Delhi, Chennai, Kolkata and Ahmedabad.
ASBA Bidder	All bidders except Anchor Investor.
ASBA Form/ Bid cum Application	An Application form (with or without UPI ID, as applicable), whether physical or electronic, used by Bidders which were be considered as the application for Allotment in terms of the Red Herring Prospectus or the Prospectus.
Banker to the Issue Agreement	Agreement dated June 25, 2024 entered into amongst the Company, Book Running Lead Manager, the Registrar, Sponsor Bank and the Banker to the Issue.
Bankers to the Issue/ Public Issue Bank/ Sponsor Bank	Banks which are clearing members and registered with SEBI as Bankers to an Issue and with whom the Public Issue Account has been opened, in this case being HDFC Bank Limited.
Basis of Allotment	The basis on which the Equity Shares is Allotted to successful bidders under the issue and which is described in the chapter titled “Issue Procedure” beginning on page 227 of this Prospectus.
Bid	An indication to make an offer during the Bid/ Issue Period by a Bidder (other than an Anchor Investor) pursuant to submission of the ASBA Form, or during the Anchor Investor Bid/ Issue Period by an Anchor Investor, pursuant to submission of the Anchor Investor Application Form, to subscribe to or purchase the Equity Shares at a price within the Price Band, including all revisions and modifications thereto as permitted under the SEBI (ICDR) Regulations and in terms of the Prospectus and the Bid cum Application Form. The term “Bidding” shall be construed accordingly.
Bid Amount	The highest value of optional Bids indicated in the Bid cum Application Form and in the case of Retail Individual Bidders Bidding at Cut Off Price, the Cap Price multiplied by the number of Equity Shares Bid for by such Retail Individual Bidder and mentioned in the Bid cum Application Form and payable by the Retail Individual Bidder or blocked in the ASBA Account upon submission of the Bid in the Issue.
Bid Lot	1200 equity shares and in multiples of 1200 equity shares thereafter.
Bidder/ Investor	Any investor who has made a Bid pursuant to the terms of the Prospectus and the Bid cum Application Form, and unless otherwise stated or implied, includes an Anchor Investor.
Bid/ Issue Closing Date	Except in relation to any Bids received from the Anchor Investors, August 14, 2024
Bid/ Issue Opening Date	Except in relation to any Bids received from the Anchor Investors, August 12, 2024
Bid/ Issue Period	Except in relation to any Bids received from the Anchor Investors, the period between the August 12 and August 14 inclusive of both days,.

Terms	Description
Bidder/ Applicant	Any investor who has made a bid pursuant to the terms of the Prospectus and the Bid-Cum-Application Form and unless otherwise stated or implied, which includes an ASBA Bidder and an Anchor Investor
Bidding	The process of making a Bid.
Bidding/ Collection Centers	Centers at which the Designated intermediaries accept the ASBA Forms, i.e., Designated SCSB Branches for SCSBs, specified locations for syndicates, broker centers for registered brokers, designated RTA Locations for RTAs and designated CDP locations for CDPs.
Book Building Process/ Book Building Method	Book building process, as provided in Part A of Schedule XIII of the SEBI (ICDR) Regulations, in terms of which the Issue is being made
BRLM / Book Running Lead Manager	Book Running Lead Manager to the Issue in this case being Hem Securities Limited, SEBI Registered Category I Merchant Banker.
Broker Centres	Broker Centres notified by the Stock Exchanges, where the investors can submit the Bid-cum Application Forms to a Registered Broker. The details of such Broker Centers, along with the names and contact details of the Registered Brokers are available on the websites of the Stock Exchange.
Business Day	Monday to Friday (except public holidays).
CAN or Confirmation of Allocation Note	The Note or advice or intimation sent to each successful Applicant indicating the Equity which allotted, after approval of Basis of Allotment by the designated Stock Exchange.
Cap Price	Rs. 105/- per equity share
Client Id	Client Identification Number maintained with one of the Depositories in relation to Demat account
Collecting Depository Participants or CDPs	A depository participant as defined under the Depositories Act, 1996, registered with SEBI and who is eligible to procure Applications at the Designated CDP Locations in terms of circular no. CIR/CFD/POLICYCELL/11/2015 dated November 10, 2015 issued by SEBI
Collecting Registrar and Share Transfer Agent	Registrar to an Issue and share transfer agents registered with SEBI and eligible to procure Bids at the Designated RTA Locations in terms of circular no. CIR/CFD/POLICYCELL/11/2015 dated November 10, 2015 issued by SEBI.
Controlling Branches of the SCSBs	Such branches of the SCSBs which coordinate with the BRLM, the Registrar to the Issue and the Stock Exchange.
Cut Off Price	The Issue Price, i.e. Rs. 105/-* per equity share finalized by our Company in consultation with the BRLM. Only Retail Individual Investors were entitled to Bid at the Cut-off Price. QIBs (including Anchor Investor) and Non-Institutional Investors are not entitled to Bid at the Cut-off Price. <i>*Subject to finalization of basis of allotment.</i>
Demographic Details	The demographic details of the applicants such as their Address, PAN, name of the applicants father/husband, investor status, Occupation and Bank Account details.
Depositor/ Depositories	A depository registered with SEBI under the Securities and Exchange Board of India (Depositories and Participants) Regulations, 1996 as amended from time to time i.e., National Securities Depository Limited (NSDL) and Central Depository Services (India) Limited (CDSL).
Depositories Act	The Depositories Act, 1996, as amended from time to time.
Designated CDP Locations	Such locations of the CDPs where Applicant can submit the Bid-cum-Application Forms to Collecting Depository Participants. The details of such Designated CDP Locations, along with names and contact details of the Collecting Depository Participants eligible to accept Bid-Cum-Application Forms are available on the website of the Stock Exchange i.e., www.nseindia.com .
Designated Date	The date on which the funds from the Anchor Escrow Accounts, the funds blocked by the SCSBs and Sponsor Bank are transferred from ASBA Accounts specified by the ASBA Bidder to the Public Issue Account and/or Refund Account and/or are unblocked, as applicable in terms of Prospectus.
Designated Intermediaries/ Collecting Agent	An SCSB's with whom the bank account to be blocked, is maintained, a syndicate member (or sub-syndicate member), a Stock Broker registered with recognized Stock Exchange, a Depository Participant, a registrar to an issue and share transfer agent (RTA) (whose names is mentioned on website of the stock exchange as eligible for this activity).
Designated Market Maker	Member Brokers of NSE who are specifically registered as Market Makers with the NSE SME Platform. In our case, Hem Finlease Private Limited is the sole Market Marker.
Designated RTA Locations	Such locations of the RTAs where Bidder submitted the Bid-Cum-Application Forms to RTAs. The details of such Designated RTA Locations, along with names and contact details of the RTAs

Terms	Description
	eligible to accept Bid-Cum-Application Forms are available on the websites of the Stock Exchange i.e., www.nseindia.com .
Designated SCSB Branches	Such branches of the SCSBs which shall collect the ASBA Application Form from the Applicant and a list of which is available on the website of SEBI at https://www.sebi.gov.in/sebiweb/other/OtherAction.do?doRecognisedFpi=yes&intmId=35 Recognized-Intermediaries or at such other website as may be prescribed by SEBI from time to time.
Designated Stock Exchange	National Stock Exchange of India Limited (NSE Emerge i.e., Emerge platform of NSE)
DP ID	Depository's Participant's Identity Number
DP/ Depository Participant	A depository participant as defined under the Depositories Act, 1996
Draft Red Herring Prospectus	Draft Red Herring Prospectus dated May 21, 2024 issued in accordance with Sections 26 & 32 of the Companies Act, 2013
Electronic Transfer of Funds	Refunds through NACH, NEFT, Direct Credit or RTGS as applicable.
Eligible NRI	A Non-Resident Indian in a jurisdiction outside India where it is not unlawful to make an offer or invitation under the Issue and in relation to whom this Prospectus will constitute an invitation to subscribe for the Equity Shares.
Eligible QFIs	QFIs from such jurisdictions outside India where it is not unlawful to make an issue or invitation under the Issue and in relation to whom the Prospectus constitutes an invitation to purchase the Equity shares issued thereby and who have opened Demat accounts with SEBI registered qualified depository participants.
Escrow Account(s)	The account(s) opened with the Escrow Collection Bank and in whose favour the Anchor Investors transferred money through NACH/direct credit/ NEFT/ RTGS in respect of the Bid Amount when submitting a Bid.
FII/ Foreign Institutional Investors	Foreign Institutional Investor as defined under SEBI (Foreign Institutional Investors) Regulations, 1995, as amended) registered with SEBI under applicable laws in India.
First Bidder/ Applicant/ Bidders	Bidder(s) whose name were mentioned in the Bid cum Application Form or the Revision Form and in case of joint bids, whose name shall also appear as the first holder of the beneficiary account held in joint names.
Floor Price	Rs. 100/- per equity share
Foreign Venture Capital Investors	Foreign Venture Capital Investors registered with SEBI under the SEBI (Foreign Venture Capital Investor) Regulations, 2000.
Fraudulent Borrower	Fraudulent borrower as defined under Regulation 2(1) (III) of the SEBI (ICDR) Regulations.
FPI/ Foreign Portfolio Investor	A Foreign Portfolio Investor who has been registered pursuant to the of Securities and Exchange Board of India (Foreign Portfolio Investors) Regulations, 2014, provided that any FII or QFI who holds a valid certificate of registration shall be deemed to be a foreign portfolio investor till the expiry of the block of three years for which fees have been paid as per the SEBI (Foreign Institutional Investors) Regulations, 1995, as amended
Fugitive Economic Offender	An individual who is declared a fugitive economic offender under Section 12 of the Fugitive Economic Offenders Act, 2018.
General Corporate Purposes	Include such identified purposes for which no specific amount is allocated or any amount so specified towards general corporate purpose or any such purpose by whatever name called, in the offer document. Provided that any issue related expenses shall not be considered as a part of general corporate purpose merely because no specific amount has been allocated for such expenses in the offer document.
General Information Document (GID)	The General Information Document for investing in public issues, prepared and issued in accordance with the SEBI circular (SEBI/HO/CFD/DIL1/CIR/P/2020/37) dated March 17, 2020 and the circular no. SEBI / HO / CFD / DIL2 / CIR / P / 2020 / 50 dated March 30, 2020, as amended by SEBI from time to time and the UPI Circulars. The General Information Document shall be available on the websites of the Stock Exchanges, and the Book Running Lead Managers.
Issue Agreement	The Issue Agreement dated May 10, 2024 between our Company and Book Running Lead Manager, Hem Securities Limited.
Issue Price	The Price at which the Equity Shares are being issued by our Company under this Prospectus being ₹105 per Equity share.
Issue Proceeds	Proceeds to be raised by our Company through this Issue, for further details please refer chapter titled " Objects of the Issue " beginning on page 70 of this Prospectus

Terms	Description
Issue/ Public Issue/ Issue size/ Initial Public Issue/ Initial Public Offering/ IPO	The Initial Public Issue of 28,80,000 Equity shares of ₹10/- each at issue price of ₹ 105/- per Equity share, including a premium of ₹ 95/- per equity share aggregating to ₹ 3024.00 lakhs
Listing Agreement	The Equity Listing Agreement to be signed between our Company and the Stock Exchange.
Lot Size	1200 equity shares
Mandate Request	Mandate Request means a request initiated on the RII by sponsor bank to authorize blocking of funds equivalent to the application amount and subsequent debit to funds in case of allotment.
Market Maker Reservation Portion	The reserved portion of 1,48,800 Equity Shares of ₹10 each at an Issue price of ₹ 105 each is aggregating to ₹ 156.24 Lakhs to be subscribed by Market Maker in this issue.
Market Making Agreement	The Market Making Agreement dated June 25, 2024 between our Company, Book Running Lead Manager and Market Maker, Hem Finlease Private Limited.
Mutual Funds	A mutual fund registered with SEBI under the SEBI (Mutual Funds) Regulations, 1996, as amended from time to time.
Net Issue	The Issue (excluding the Market Maker Reservation Portion) of 27,31,200 equity Shares of ₹10/- each at a price of ₹ 105 per Equity Share (the “ Issue Price ”), including a share premium of ₹ 100 per equity share aggregating to ₹ 2867.76 Lakhs.
Net Proceeds	The Issue Proceeds received from the fresh Issue excluding Issue related expenses. For further information on the use of Issue Proceeds and Issue expenses, please refer to the section titled “ Objects of the Issue ” beginning on page 70 of this Prospectus.
NCLT	National Company Law Tribunal
Net QIB Portion	The portion of the QIB Portion less the number of Equity Shares Allocated to the Anchor Investors
NPCI	NPCI, a Reserve Bank of India (RBI) initiative, is an umbrella organization for all retail payments in India. It has been set up with the guidance and support of the Reserve Bank of India (RBI) and Indian Banks Association (IBA).
Non- Resident	A person resident outside India, as defined under FEMA and includes NRIs, FPIs and FVCIs
Non-Institutional Bidders	All Bidders that are not QIBs, RIBs or Eligible Employees Bidding in the Employee Reservation Portion and who have Bid for Equity Shares, for an amount of more than ₹200,000 (but not including NRIs other than Eligible NRIs)
Non-Institutional Portion	The portion of the Issue being not less than 15% of the Issue, consisting of 4,10,400 Equity Shares, which was made available for allocation on a proportionate basis to Non Institutional Investors, subject to valid Bids being received at or above the Issue Price.
Other Investor	Investors other than Retail Individual Investors. These include individual applicants other than retail individual investors and other investors including corporate bodies or institutions irrespective of the number of specified securities applied for.
Overseas Corporate Body/ OCB	Overseas Corporate Body means and includes an entity defined in clause (xi) of Regulation 2 of the Foreign Exchange Management (Withdrawal of General Permission to Overseas Corporate Bodies (OCB’s) Regulations 2003 and which was in existence on the date of the commencement of these Regulations and immediately prior to such commencement was eligible to undertake transactions pursuant to the general permission granted under the Regulations. OCBs are not allowed to invest in this Issue.
Pay-in-Period	The period commencing on the Bid/Issue Opening date and extended till the closure of the Anchor Investor Pay-in-Date.
Payment through electronic transfer of funds	Payment through NECS, NEFT or Direct Credit, as applicable.
Person/ Persons	Any individual, sole proprietorship, unincorporated association, unincorporated organization, body corporate, corporation, company, partnership, limited liability company, joint venture, or trust or any other entity or organization validly constituted and/ or incorporated in the jurisdiction in which it exists and operates, as the context requires.
Price Band	Price Band of a minimum price (Floor Price) of ₹100/- and the maximum price (Cap Price) of ₹105/- and includes revisions thereof. The Price Band was decided by our Company in consultation with the BRLM and advertised in all editions of the English national newspaper Business Standard, all editions of Hindi national newspaper Business Standard and Gujarati Edition of Ahmedabad Express, Regional Newspaper (Gujarati being the Regional Language of Kheda where our registered office is located) at least two working days prior to the Bid/ Issue Opening Date.
Pricing Date	The date on which our Company in consultation with the BRLM, finalized the Issue Price.

Terms	Description
Prospectus	This Prospectus dated August 16, 2024, to be filed with the Registrar of Companies, Ahmedabad in accordance with the provisions of Section 26 & 32 of the Companies Act, 2013, containing, inter alia, the Issue Price, size of the Issue and certain other information.
Public Issue Account	The bank account was opened with the Public Offer Account Bank under Section 40(3) of the Companies Act, 2013, to receive monies from the Escrow Account and from the ASBA Accounts on the Designated Date.
Public Issue Account Bank	Bank which is a clearing member and registered with SEBI as a banker to an issue, and with whom the Public Issue Account(s) has been opened
QIB Category/ QIB Portion	The portion of the Net Issue (including the Anchor Investor Portion) being not more than 50% of the Net Issue, consisting of 13,64,400 Equity Shares which were made available for allocation to QIBs (including Anchor Investors) on a proportionate basis, (in which allocation Anchor Investor were made available on a discretionary basis, as determined by our Company in consultation with the BRLMs), subject to valid Bids being received at or above the Issue Price.
Qualified Institutional Buyers/ QIBs/ QIB Bidders	Qualified institutional buyers as defined under Regulation 2(1)(ss) of the SEBI (ICDR) Regulations.
Red Herring Prospectus / RHP	The Red Herring Prospectus to be issued in accordance with Section 32 of the Companies Act, 2013 and the provisions of the SEBI (ICDR) Regulations, which did not have complete particulars of the price at which the Equity Shares offered and the size of the Issue including any addenda or corrigenda thereto.
Refund Account	The 'no-lien' and 'non-interest bearing' account opened with the Refund Bank, from which refunds, if any, of the whole or part, of the Bid Amount to the Anchor Investors shall be made.
Refund Bank/ Refund Banker	Bank which is / are clearing member(s) and registered with the SEBI as Bankers to the Issue at which the Refund Account has been opened, in this case being HDFC Bank Limited.
Refund through electronic transfer of funds	Refunds through NECS, direct credit, RTGS or NEFT, as applicable.
Registered Broker	The stockbrokers registered with the stock exchanges having nationwide terminals, other than the members of the Syndicate and eligible to procure Bids
Registrar Agreement	The agreement dated May 10, 2024 entered into between our Company and the Registrar to the Issue in relation to the responsibilities and obligations of the Registrar to the Issue pertaining to the Issue.
Registrar and Share Transfer Agents or RTAs	Registrar and share transfer agents registered with SEBI and eligible to procure Applications at the Designated RTA Locations in terms of circular no. CIR/CFD/POLICYCELL/11/2015 dated November 10, 2015 issued by SEBI.
Registrar/ Registrar to the Issue/ RTA/ RTI	Registrar to the Issue, in this case being Cameo Corporate Services Limited.
Regulation S	Regulation S under the U.S. Securities Act of 1933, as amended from time to time.
Reservation Portion	The portion of the Issue reserved for category of eligible Applicants as provided under the SEBI (ICDR) Regulations, 2018.
Reserved Category/ Categories	Categories of persons eligible for making application under reservation portion.
Retail Individual Bidders/ RIBs/ Retail Individual Investors/ RIIs	Individual Bidders, submitting Bids, who have Bid for Equity Shares for an amount not more than ₹ 2,00,000/- in any of the bidding options in the Net Issue (including HUFs applying through their Karta and Eligible NRIs and does not include NRIs other than Eligible NRIs).
Retail Portion	The portion of the Issue being not less than 35% of the Net Issue, consisting of 9,56,400 Equity Shares, which was made available for allocation to Retail Individual Bidders subject to valid Bids having been received at or above the Issue Price).
Revision Form	Form used by the Bidders to modify the quantity of the Equity Shares or the Bid Amount in any of their Bid cum Application Forms or any previous Revision Form(s), as applicable. QIB Bidders and Non-Institutional Investors are not allowed to withdraw or lower their Bids (in terms of quantity of Equity Shares or the Bid Amount) at any stage. Retail Individual Investors and Eligible Employees can revise their Bids during the Bid/ Issue Period and withdraw their Bids until the Bid/ Offer Closing Date.
Securities laws	Means the Act, the Securities Contracts (Regulation) Act, 1956, the Depositories Act, 1996 and the rules and regulations made thereunder and the general or special orders, guidelines or circulars made or issued by the Board thereunder and the provisions of the Companies Act, 2013 or any previous company law and any subordinate legislation framed thereunder, which are administered by the Board.

Terms	Description
SEBI (ICDR) Regulations/ ICDR Regulation/ Regulation	SEBI (Issue of Capital and Disclosure Requirements) Regulations, 2018 issued by SEBI on September 11, 2018, as amended, including instructions and clarifications issued by SEBI from time to time.
SEBI (Venture Capital) Regulations	Securities Exchange Board of India (Venture Capital) Regulations, 1996 as amended from time to time.
SEBI Act/ SEBI	Securities and Exchange Board of India Act, 1992, as amended from time to time.
SEBI Insider Trading Regulations	The Securities and Exchange Board of India (Prohibition of Insider Trading) Regulations, 2015 as amended, including instructions and clarifications issued by SEBI from time to time.
SEBI Listing Regulations, 2015/ SEBI Listing Regulations/ Listing Regulations/ SEBI (LODR)	The Securities and Exchange Board of India (Listing Obligation and Disclosure Requirements) Regulations, 2015 as amended, including instructions and clarifications issued by SEBI from time to time.
SEBI Takeover Regulations or SEBI (SAST) Regulations	Securities and Exchange Board of India (Substantial Acquisition of Shares and Takeover) Regulations, 2011, as amended from time to time.
Self-Certified Syndicate Bank(s) / SCSB(s)	Shall mean a Banker to an Issue registered under Securities and Exchange Board of India (Bankers to an Issue) Regulations, 1994, as amended from time to time, and which offer the service of making Application/s Supported by Blocked Amount including blocking of bank account and a list of which is available on https://www.sebi.gov.in/sebiweb/other/OtherAction.do?doRecognisedFpi=yes&intmId=35 or at such other website as may be prescribed by SEBI from time to time.
SME Exchange	Emerge Platform of the National Stock Exchange of India Limited i.e., “NSE EmERGE”
Specified Locations	Collection centres where the SCSBs shall accept application form, a list of which is available on the website of SEBI (https://www.sebi.gov.in/) and updated from time to time.
Specified Securities	Equity shares offered through this Prospectus.
Sponsor Bank	Sponsor Bank means a Banker to the Issue registered with SEBI, which is appointed by the Issuer to act as a conduit between the Stock Exchanges and NPCI (National Payments Corporation of India) in order to push the mandate, collect requests and / or payment instructions of the Retail Investors into the UPI.
Sub Syndicate Member	A SEBI Registered member of NSE appointed by the BRLM and/ or syndicate member to act as a Sub Syndicate Member in the Issue.
Syndicate	Includes the BRLM, Syndicate Members and Sub Syndicate Members.
Syndicate Agreement	The agreement dated June 25, 2024 entered into amongst our Company, the BRLM and the Syndicate Members, in relation to the collection of Bids in this Issue.
Syndicate ASBA Bidding Locations	Bidding Centers where an ASBA Bidder can submit their Bid in terms of SEBI Circular no. CIR/CFD/DIL/1/2011 dated April 29, 2011, namely Mumbai, Chennai, Kolkata, Delhi
Syndicate Members/ Members of the Syndicate	Intermediaries registered with SEBI eligible to act as a syndicate member and who is permitted to carry on the activity as an underwriter, in this case being Hem Finlease Private Limited.
Systemically Important Non-Banking Financial Company	Systemically important non-banking financial company as defined under Regulation 2(1)(iii) of the SEBI (ICDR) Regulations.
Transaction Registration Slip/ TRS	The slip or document issued by the member of the Syndicate or SCSB (only on demand) as the case may be, to the Applicant as proof of registration of the Application.
U.S. Securities Act	U.S. Securities Act of 1933, as amended
Underwriter	The BRLM who has underwritten this Issue pursuant to the provisions of the SEBI (ICDR) Regulations, 2018 and the Securities and Exchange Board of India (Underwriters) Regulations, 1993, as amended from time to time.
Underwriting Agreement	The Agreement June 25, 2024 entered between the Underwriter, BRLM and our Company.
UPI	UPI is an instant payment system developed by the NCPI, it enables merging several banking features, seamless fund routing & merchant payment into one hood. UPI allow instant transfer of money between any two bank accounts using a payment address which uniquely identifies a person's bank account
UPI Circulars	SEBI circular number SEBI/HO/CFD/DIL2/CIR/P/2018/138 dated November 1, 2018, SEBI circular number SEBI/HO/CFD/DIL2/CIR/P/2019/50 dated April 3, 2019, SEBI circular number SEBI/HO/CFD/DIL2/CIR/P/2019/76 dated June 28, 2019, SEBI circular number SEBI/HO/CFD/DIL2/CIR/P/2019/85 dated July 26, 2019, SEBI circular number SEBI/HO/CFD/DCR2/CIR/P/2019/133 dated November 8, 2019, SEBI circular number SEBI/HO/CFD/DIL2/CIR/P/2020 dated March 30, 2020, SEBI circular number SEBI/HO/CFD/DIL2/CIR/P/2021/2480/1/M dated March 16, 2021, SEBI circular number

Terms	Description
	SEBI/HO/CFD/DIL2/P/CIR/2021/570 dated June 2, 2021, SEBI circular no. SEBI/HO/CFD/DIL2/P/CIR/P/2022/45 dated April 5, 2022, SEBI circular no. SEBI/HO/CFD/DIL2/P/CIR/P/2022/51 dated April 20, 2022, SEBI Circular No. SEBI/HO/CFD/DIL2/P/CIR/2022/75 dated May 30, 2022, SEBI master circular no. SEBI/HO/CFD/PoD-2/P/CIR/2023/00094 dated June 21, 2023, along with the circular issued by the NSE having reference no. 23/2022 dated July 22, 2022 and reference no. 25/2022 dated August 3, 2022 and the notice issued by BSE having reference no. 20220722- 30 dated July 22, 2022 and reference no. 20220803-40 dated August 3, 2022 and any subsequent circulars or notifications issued by SEBI or the Stock Exchanges in this regard.
UPI ID	ID created on the UPI for single-window mobile payment system developed by the NPCI
UPI Mandate Request/ Mandate Request	A request (intimating the RII by way of notification on the UPI application and by way of a SMS directing the RII to such UPI application) to the RII by sponsor bank to authorize blocking of funds equivalent to the application amount and subsequent debit to funds in case of allotment.
UPI Mechanism	The mechanism that was used by an RIB to make a Bid in the Offer in accordance with the UPI Circulars on Streamlining of Public Issues
UPI PIN	Password to authenticate UPI transaction
Venture Capital Fund/ VCF	Foreign Venture Capital Funds (as defined under the Securities and Exchange Board of India (Venture Capital Funds) Regulations, 1996) registered with SEBI under applicable laws in India.
WACA	Weighted average cost of acquisition.
Wilful Defaulter(s)	Wilful defaulter as defined under Regulation 2(1) (III) of the SEBI (ICDR) Regulations, 2018.
Working Day	In accordance with Regulation 2(1) (mmm) of SEBI (ICDR) Regulations, 2018, working days' means, all days on which commercial banks in Mumbai are open for business. However, in respect of– (a) announcement of Price Band; and (b) Issue period, working days shall mean all days, excluding Saturdays, Sundays and public holidays, on which commercial banks in Mumbai are open for business; (c) the time period between the Bid/ Issue Closing Date and the listing of the Equity Shares on the Stock Exchange, working day shall mean all trading days of the Stock Exchange, excluding Sundays and bank holidays, as per circulars issued by SEBI.

Technical and Industry Related Terms

Term	Description
Al	Aluminum
ADC	Aluminum-Alloy Die Castings
ARF	Advanced Recovery Fee (ARF)
APC	Air Pollution Control
DG	Diesel Generator
DEC	Department of Environmental Conservation
EEE	Electrical and electronic equipment
EOL	End of Life
EOU	End of Use
E-WASTE	Electronic Waste
EVs	Electronic Vehicles
ERP	Enterprise resource management
EMDE	Emerging Market & Developing Economies
MoEF&CC	Environment, Forest, and Climate Change Ministry
FCI	Food Corporation of India
FMCG	Fast moving consumer goods
FDI	Foreign Direct Investment
FIPB	Foreign Investment Promotion Board
FMCG	Fast Moving Consumer Goods
FSSAI	Food Safety and Standards Authority of India
FTL/FCL	Full Truck Load
FICCI	Federation of Indian Chambers of Commerce and Industry
FMV	Fair Market Value

FG	Finished Goods
GPS	Global Positioning System
GST	Goods and Services Tax
GFS	Global forwarding solutions
GVA	Gross Value of Added
HP	Horse Power
H1	First Half
IAER	International Association of Electronic Recycler
IEC	Information, Education and Communication
IPQC	In Process Quality Control
IIP	Index of Industrial Production
ITM	International Transportation Management
IMF	International Monetary Fund
ITeS	Information technology-enabled services
IT	Information Technology
IAI	International Aluminium Institute
IAER	International Association of Electronic Recycler
KPI	Key performance indicators
KWH	Kilowatt-hour
KVA	Kilo voltage
LED	Light-emitting diode
MRP	Maximum Retail Price
MGO	Magnesium oxide
MRF	Material Recovery Facility
MN	Million
MT	Metric Ton
MW	Mega Watt
NEP	National Environmental Policy
PCC	Pollution Control Committees
PVC	Polyvinyl chloride
P & M	Plant and Machinery
PM	Packing Material
R&D	Research and development
RR	Recycling rate
Sq. Ft.	Square Feet
SBM-U	Swachh Bharat Mission (Urban)
SPCB	State Pollution Control Board
SPV	Special Purpose Vehicle
SWM	Solid waste management
SMEs	Small and Medium sized Enterprises
TMS	Transport management system
TPD	Tonnes per day
TPA	Tonnes per annum
TPY	Tonnes per year
UV	Utility vehicles
VAS	Value added services
WEEE	Waste electrical and electronic equipment
WHO	World Health Organization

Conventional terms and Abbreviations

Abbreviation	Full Form
Rs./ Rupees/ INR/ ₹	Indian Rupees
AS / Accounting Standard	Accounting Standards as issued by the Institute of Chartered Accountants of India
A/c	Account
ACS	Associate Company Secretary

Abbreviation	Full Form
AGM	Annual General Meeting
ASBA	Applications Supported by Blocked Amount
Amt.	Amount
AIF	Alternative Investment Funds registered under the Securities and Exchange Board of India (Alternative Investment Funds) Regulations, 2012, as amended.
AY	Assessment Year
AOA	Articles of Association
Approx	Approximately
B. A	Bachelor of Arts
B. Com	Bachelor of Commerce
B. E	Bachelor of Engineering
B. Sc	Bachelor of Science
B. Tech	Bachelor of Technology
Bn	Billion
BG/LC	Bank Guarantee / Letter of Credit
BIFR	Board for Industrial and Financial Reconstruction
BRLM	Book Running Lead Manager
BSE	BSE Limited
CDSL	Central Depository Services (India) Limited
CAGR	Compounded Annual Growth Rate
CAN	Confirmation of Allocation Note
Companies Act, 2013	Companies Act, 2013 to the extent in force pursuant to the notification of sections of the Companies Act, 2013 along with the relevant rules made thereunder as amended.
Companies Act, 1956	Companies Act, 1956 (without reference to the provisions that have ceased upon notification of the Companies Act, 2013) along with the relevant rules made thereunder.
CA	Chartered Accountant
Client ID	Client identification number of the Bidder's beneficiary account
CAIIB	Certified Associate of Indian Institute of Bankers
CB	Controlling Branch
CC	Cash Credit
CIN	Corporate Identification Number
CIT	Commissioner of Income Tax
CS	Company Secretary
CS & CO	Company Secretary & Compliance Officer
CFO	Chief Financial Officer
CSR	Corporate Social Responsibility
C.P.C.	Code of Civil Procedure, 1908
CrPC	Code of Criminal Procedure, 1973
CENVAT	Central Value Added Tax
CST	Central Sales Tax
CWA/ICWA	Cost and Works Accountant
CMD	Chairman and Managing Director
DIN	Director Identification Number
DIPP	Department of Industrial Policy and Promotion, Ministry of Commerce, Government of India
DP	Depository Participant
Depositories Act	The Depositories Act, 1996, read with the rules, regulations, clarifications and modifications Thereunder
Depository	A depository registered with the SEBI under the Securities and Exchange Board of India (Depositories and Participants) Regulations, 2018
DP ID	Depository Participant's Identification Number
EBITDA	Earnings Before Interest, Taxes, Depreciation & Amortization
ECS	Electronic Clearing System
ESIC	Employee's State Insurance Corporation
EPFA	Employee's Provident Funds and Miscellaneous Provisions Act, 1952
EMI	Equated Monthly Installment

Abbreviation	Full Form
EPS	Earnings Per Share
EGM /EOGM	Extraordinary General Meeting
ESOP	Employee Stock Option Plan
EXIM/ EXIM Policy	Export – Import Policy
FCNR Account	Foreign Currency Non Resident (Bank) account established in accordance with the provisions of FEMA
FIPB	Foreign Investment Promotion Board
FY / Fiscal/Financial Year	Period of twelve months ended March 31 of that particular year, unless otherwise stated
FEMA	Foreign Exchange Management Act, 1999 as amended from time to time, and the regulations framed there under.
FBT	Fringe Benefit Tax
FDI	Foreign Direct Investment
FIs	Financial Institutions
FIIs	Foreign Institutional Investors (as defined under Foreign Exchange Management (Transfer or Issue of Security by a Person Resident outside India) Regulations, 2000) registered with SEBI under applicable laws in India
FPIs	Foreign Portfolio Investor” means a person who satisfies the eligibility criteria prescribed under regulation 4 and has been registered under Chapter II of Securities And Exchange Board of India (Foreign Portfolio Investors) Regulations, 2014, which shall be deemed to be an intermediary in terms of the provisions of the SEBI Act, 1992
FTA	Foreign Trade Agreement
FVCI	Foreign Venture Capital Investors registered with SEBI under the Securities and Exchange Board of India (Foreign Venture Capital Investors) Regulations, 2000.
FEMA	Foreign Exchange Management Act, 1999, including the rules and regulations thereunder
FEMA Rules	Foreign Exchange Management (Non-debt Instruments) Rules, 2019
Finance Act	Finance Act, 1994
Fraudulent Borrower	A fraudulent borrower as defined in Regulation 2(1) (III) of the SEBI (ICDR) Regulations.
FV	Face Value
Fugitive Economic Offender	An individual who is declared a fugitive economic offender under Section 12 of the Fugitive Economic Offenders Act, 2018
GoI/Government	Government of India
GDP	Gross Domestic Product
GIR Number	General Index Registry Number
GST	Goods and Services Tax
GVA	Gross Value Added
HUF	Hindu Undivided Family
HNI	High Net Worth Individual
HSL	Hem Securities Limited
IBC	The Insolvency and Bankruptcy Code, 2016
ICAI	The Institute of Chartered Accountants of India
ISIN	International Securities Identification Number
IST	Indian Standard Time
ICWAI	The Institute of Cost Accountants of India
IMF	International Monetary Fund
IIP	Index of Industrial Production
IPO	Initial Public Offer
ICSI	The Institute of Company Secretaries of India
IT Act	The Information Technology Act, 2000
IFRS	International Financial Reporting Standards
INR / ₹/ Rupees	Indian Rupees, the legal currency of the Republic of India
I.T. Act	Income Tax Act, 1961, as amended from time to time
IT Authorities	Income Tax Authorities
IT Rules	Income Tax Rules, 1962, as amended, except as stated otherwise

Abbreviation	Full Form
Indian GAAP	Generally Accepted Accounting Principles in India notified under Section 133 of the Companies Act 2013 and read together with paragraph 7 of the Companies (Accounts) Rules, 2014 and Companies (Accounting Standards) Amendment Rules, 2016
Ind AS	Indian Accounting Standards as referred to in and notified by the Ind AS Rules
Ind AS Rules	The Companies (Indian Accounting Standard) Rules, 2015
IRDA	Insurance Regulatory and Development Authority
JV/ Joint Venture	A commercial enterprise undertaken jointly by two or more parties which otherwise retain their distinct identities.
KMP	Key Managerial Personnel
LLB	Bachelor of Law
Ltd.	Limited
LLP	Limited Liability Partnership
MAT	Minimum Alternate Tax
MoF	Ministry of Finance, Government of India
MoU	Memorandum of Understanding
M. A	Master of Arts
MCA	Ministry of Corporate Affairs, Government of India
M. B. A	Master of Business Administration
MAT	Minimum Alternate Tax
M. Com	Master of Commerce
Mn	Million
M. E	Master of Engineering
M. Tech	Masters of Technology
Merchant Banker	Merchant Banker as defined under the Securities and Exchange Board of India (Merchant Bankers) Regulations, 1992
MSME	Micro, Small and Medium Enterprises
MAPIN	Market Participants and Investors Database
NA	Not Applicable
NCLT	National Company Law Tribunal
Networth	The aggregate of paid up Share Capital and Share Premium account and Reserves and Surplus (Excluding revaluation reserves) as reduced by aggregate of Miscellaneous Expenditure (to the extent not written off) and debit balance of Profit & Loss Account
NACH	National Automated Clearing House
NEFT	National Electronic Funds Transfer
NECS	National Electronic Clearing System
NAV	Net Asset Value
NCT	National Capital Territory
NPV	Net Present Value
NRI's	Non-Resident Indians
NRE Account	Non Resident External Account
NRO Account	Non Resident Ordinary Account
NSE	National Stock Exchange of India Limited
NOC	No Objection Certificate
NSDL	National Securities Depository Limited
OCB or Overseas Corporate Body	A company, partnership, society or other corporate body owned directly or indirectly to the extent of at least 60% by NRIs including overseas trusts in which not less than 60% of the beneficial interest is irrevocably held by NRIs directly or indirectly and which was in existence on October 3, 2003 and immediately before such date was eligible to undertake transactions pursuant to the general permission granted to OCBs under the FEMA. OCBs are not allowed to invest in the Issue.
P.A.	Per Annum
PF	Provident Fund
PG	Post Graduate
PGDBA	Post Graduate Diploma in Business Administration
PLR	Prime Lending Rate
PAC	Persons Acting in Concert

Abbreviation	Full Form
P/E Ratio	Price/Earnings Ratio
PAN	Permanent Account Number
PAT	Profit After Tax
P.O.	Purchase Order
PBT	Profit Before Tax
PLI	Postal Life Insurance
POA	Power of Attorney
PSU	Public Sector Undertaking(s)
Pvt.	Private
Q.C.	Quality Control
RoC	Registrar of Companies
RBI	The Reserve Bank of India
Registration Act	Registration Act, 1908
ROE	Return on Equity
R&D	Research & Development
RONW	Return on Net Worth
RTGS	Real Time Gross Settlement
SCRA	Securities Contracts (Regulation) Act, 1956, as amended from time to time
SCRR	Securities Contracts (Regulation) Rules, 1957, as amended from time to time
SME	Small and Medium Enterprises
SCSB	Self-Certified syndicate Banks
STT	Securities Transaction Tax
Sub-Account	Sub-accounts registered with SEBI under the SEBI (Foreign Institutional Investor) Regulations, 1995, other than sub-accounts which are foreign corporate or foreign individuals.
Sec.	Section
SPV	Special Purpose Vehicle
TAN	Tax Deduction Account Number
TRS	Transaction Registration Slip
Trade Marks Act	Trade Marks Act, 1999
TIN	Taxpayers Identification Number
UIN	Unique identification number
U.N.	United Nations
US/United States	United States of America
UAE	United Arab Emirates
USD/ US\$/ \$	United States Dollar, the official currency of the United States of America
U.S. GAAP	Generally Accepted Accounting Principles in the United States of America
U.S. Securities Act	United States Securities Act of 1933
VAT	Value Added Tax
VCF/ Venture Capital Fund	Venture Capital Funds (as defined under the Securities and Exchange Board of India (Venture Capital Funds) Regulations, 1996) registered with SEBI under applicable laws in India.
Wilful Defaulter(s)	Company or person categorized as a wilful defaulter by any bank or financial institution (as defined under the Companies Act, 2013) or consortium thereof, in accordance with the guidelines on wilful defaulters issued by the Reserve Bank of India and includes any company whose director or promoter is categorized as such and as defined under Regulation 2(1)(III) of the SEBI (ICDR) Regulations, 2018.
WDV	Written Down Value
WTD	Whole Time Director
w.e.f.	With effect from
-, (₹)	Represent Outflow

The words and expressions used but not defined in this Prospectus will have the same meaning as assigned to such terms under the Companies Act, 2013, the Securities and Exchange Board of India Act, 1992 (the “SEBI Act”), the SCRA, SEBI (Issue of Capital and Disclosure Requirements) Regulations, 2018 the Depositories Act and the rules and regulations made thereunder.

CERTAIN CONVENTIONS, USE OF FINANCIAL INFORMATION AND MARKET DATA AND CURRENCY OF FINANCIAL PRESENTATION

Certain Conventions

In this Prospectus, the terms “we”, “us”, “our”, the “Company”, “our Company”, unless the context otherwise indicates or implies, refers to Sunlite Recycling Industries Limited. All references in the Prospectus to “India” are to the Republic of India. All references in the Prospectus to the “U.S.”, “USA” or “United States” are to the United States of America.

In this Prospectus, unless the context otherwise requires, all references to one gender also refers to another gender and the word “Lac / Lakh” means “one hundred thousand”, the word “million (mn)” means “Ten Lac / Lakh”, the word “Crore” means “ten million” and the word “billion (bn)” means “one hundred crore”. In this Prospectus, any discrepancies in any table between total and the sum of the amounts listed are due to rounding-off.

Use of Financial Data

Unless stated otherwise, throughout this Prospectus, all figures have been expressed in Rupees and Lakh. Unless stated otherwise, the financial data in the Prospectus is derived from our restated financial statements prepared for the financial year ended 31st March 2024, 31st March, 2023 and 31st March, 2022 in accordance with Indian GAAP, the Companies Act and SEBI (ICDR) Regulations, 2018 included under Section titled “*Financial Information of the Company*” beginning on page 144 of this Prospectus.

There are significant differences between Indian GAAP, the International Financial Reporting Standards (“IFRS”) and the Generally Accepted Accounting Principles in the United States of America (“U.S. GAAP”). Accordingly, the degree to which the Indian GAAP financial statements included in this Prospectus will provide meaningful information is entirely dependent on the reader’s level of familiarity with Indian accounting practice and Indian GAAP. Any reliance by persons not familiar with Indian accounting practices on the financial disclosures presented in this Prospectus should accordingly be limited. We have not attempted to explain those differences or quantify their impact on the financial data included herein, and we urge you to consult your own advisors regarding such differences and their impact on our financial data.

Any percentage amounts, as set forth in “*Risk Factors*”, “*Our Business*”, “*Management’s Discussion and Analysis of Financial Condition and Results of Operations*” and elsewhere in the Prospectus unless otherwise indicated, have been calculated on the basis of the Company’s restated financial statements prepared in accordance with the applicable provisions of the Companies Act, Indian GAAP and restated in accordance with SEBI (ICDR) Regulations, 2018, as stated in the report of our Statutory Auditor, set out in section titled “*Financial Information of the Company*” beginning on page 144 of this Prospectus. The company does not have any subsidiary as on date of the Prospectus. Our fiscal year commences on April 1 of every year and ends on March 31 of every next year.

For additional definitions used in this Prospectus, see the section “*Definitions and Abbreviations*” on page 1 of this Prospectus. In the section titled “*Main Provisions of the Articles of Association of our Company*”, on page 250 of the Prospectus defined terms have the meaning given to such terms in the Articles of Association of our Company.

Use of Industry & Market Data

Unless stated otherwise, industry and market data and forecast used throughout the Prospectus was obtained from internal Company reports, data, websites, Industry publications report as well as Government Publications. Industry publication data and website data generally state that the information contained therein has been obtained from sources believed to be reliable, but that their accuracy and completeness and underlying assumptions are not guaranteed and their reliability cannot be assured.

Although, we believe industry and market data used in the Prospectus is reliable, it has not been independently verified by us or the Book Running Lead Manager or any of their affiliates or advisors. Similarly, internal Company reports and data, while believed by us to be reliable, have not been verified by any independent source. There are no standard data gathering methodologies in the industry in which we conduct our business and methodologies and assumptions may vary widely among different market and industry sources.

In accordance with the SEBI (ICDR) Regulations, 2018 the section titled “*Basis for Issue Price*” on page 77 of the Prospectus includes information relating to our peer group companies. Such information has been derived from publicly available sources, and neither we, nor the Book Running Lead Manager, have independently verified such information.

Currency of Financial Presentation

All references to “Rupees” or “INR” or “₹” or “₹” are to Indian Rupees, the official currency of the Republic of India. Except where specified, including in the section titled “*Industry Overview*” throughout the Prospectus all figures have been expressed in Lakhs.

Any percentage amounts, as set forth in “*Risk Factors*”, “*Our Business*”, “*Management's Discussion and Analysis of Financial Conditions and Results of Operations*” on page 25, 98 and 185 respectively of this Prospectus, unless otherwise indicated, have been calculated based on our restated financial statements prepared in accordance with Indian GAAP.

The Prospectus contains conversion of certain US Dollar and other currency amounts into Indian Rupees that have been presented solely to comply with the requirements of the SEBI (ICDR) Regulations, 2018. These conversions should not be construed as a representation that those US Dollar or other currency amounts could have been, or can be converted into Indian Rupees, at any particular rate.

FORWARD LOOKING STATEMENTS

This Prospectus includes certain “forward-looking statements”. We have included statements in the Prospectus which contain words or phrases such as “will”, “aim”, “is likely to result”, “believe”, “expect”, “will continue”, “anticipate”, “estimate”, “intend”, “plan”, “contemplate”, “seek to”, “future”, “objective”, “goal”, “project”, “should”, “will pursue” and similar expressions or variations of such expressions, that are “forward-looking statements”. Also, statements which describe our strategies, objectives, plans or goals are also forward looking statements.

All forward looking statements are subject to risks, uncertainties and assumptions about us that could cause actual results to differ materially from those contemplated by the relevant forward-looking statement. Forward-looking statements reflect our current views with respect to future events and are not a guarantee of future performance. These statements are based on our management’s beliefs and assumptions, which in turn are based on currently available information. Although we believe the assumptions upon which these forward-looking statements are based are reasonable, any of these assumptions could prove to be inaccurate, and the forward-looking statements based on these assumptions could be incorrect. Important factors that could cause actual results to differ materially from our expectations include but are not limited to:

1. General economic and business conditions in the markets in which we operate and in the local, regional, national and international economies;
2. Changes in consumer demand;
3. Failure to successfully upgrade our product portfolio, from time to time;
4. Any change in government policies resulting in increases in taxes payable by us;
5. Our ability to successfully implement strategy, growth and expansion plans and technological initiatives;
6. Our ability to retain our key managements persons and other employees;
7. Changes in laws and regulations that apply to the industries in which we operate.
8. Our failure to keep pace with rapid changes in technology;
9. Our ability to grow our business;
10. Our ability to make interest and principal payments on our existing debt obligations and satisfy the other covenants contained in our existing debt agreements;
11. general economic, political and other risks that are out of our control;
12. Inflation, deflation, unanticipated turbulence in interest rates, equity prices or other rates or prices;
13. Company’s ability to successfully implement its growth strategy and expansion plans;
14. failure to comply with regulations prescribed by authorities of the jurisdictions in which we operate;
15. inability to successfully obtain registrations in a timely manner or at all;
16. occurrence of Environmental Problems & Uninsured Losses;
17. conflicts of interest with affiliated companies, the promoter group and other related parties;
18. any adverse outcome in the legal proceedings in which we are involved;
19. Concentration of ownership among our Promoter;
20. The performance of the financial markets in India and globally;
21. Global distress due to pandemic, war or by any other reason.

For further discussion of factors that could cause our actual results to differ, see the Section titled “*Risk Factors*”, “*Our Business*” and “*Management’s Discussion and Analysis of Financial Condition and Results of Operations*” beginning on page 25, 98 and 185 respectively of the Prospectus. By their nature, certain market risk disclosures are only estimates and could be materially different from what actually occurs in the future. As a result, actual future gains or losses could materially differ from those that have been estimated.

There can be no assurance to investors that the expectations reflected in these forward-looking statements will prove to be correct. Given these uncertainties, investors are cautioned not to place undue reliance on such forward-looking statements and not to regard such statements to be a guarantee of our future performance.

Neither our Company or our Directors or our Officers or Book Running Lead Manager or Underwriter nor any of their respective affiliates have any obligation to update or otherwise revise any statements reflecting circumstances arising after the date hereof or to reflect the occurrence of underlying events, even if the underlying assumptions do not come to fruition. In accordance with SEBI requirements, our Company and the Book Running Lead Manager will ensure that investors in India are informed of material developments until such time as the grant of listing and trading permission by the Stock Exchange for the Equity Shares allotted pursuant to this Issue.

SECTION II – SUMMARY OF PROSPECTUS**A. OVERVIEW OF BUSINESS**

We are engaged in the business of manufacturing of copper rods & wires, copper earthing wires, copper earthing strips, copper conductors, copper wire bars etc. through recycling of copper scrap, which has electrical and mechanical properties suitable for applications in power generation, transmission, distribution and electronic industries. Further, we are also engaged in providing job work services for processing of various products of copper. We employ an internal quality control mechanism to ensure that our finished product conforms to the exact requirement of our customers.

For further details, please refer to the chapter titled “**Our Business**” beginning on page 98 of this Prospectus.

B. OVERVIEW OF THE INDUSTRY

While global copper consumption growth would remain tepid at 2% in CY2023, ICRA projects domestic copper demand growth at a healthy ~11% in FY2024 and FY2025. Domestic refined copper demand growth is expected to remain healthy at 11% in FY 2024 and FY 2025 outpacing the rate of global growth in copper demand, given the Government of India’s (GoI’s) thrust on infrastructure development and a gradual transition to renewable energy. In the domestic market, around 40% of the copper is consumed by infrastructure and construction sector and 11-13% each in the automobile and consumer durable sectors. Significant emphasis by GoI towards affordable housing schemes, smart city projects, the Defence sector as well as the expected higher penetration of EVs and its associated infrastructure bode well for the domestic copper demand outlook.

For further details, please refer to the chapter titled “**Industry Overview**” beginning on page 86 of this Prospectus.

C. OUR PROMOTERS

The Promoters of our Company are Nitin Kumar Heda, Prahladrail Ramdayal Heda, Khushboo Manishkumar Heda and Manish Kumar Heda.

D. DETAILS OF THE ISSUE

This is an Initial Public Issue of 28,80,000 Equity Shares of face value of Rs. 10 each of our Company for cash at a price of Rs. 105 per Equity Share (including a share premium of Rs. 95 per Equity Share) aggregating to Rs. 3024.00 lakhs (“**The Issue**”), out of which 1,48,800 Equity Shares of face value of Rs. 10 each for cash at a price of Rs. 105 per Equity Share aggregating up to Rs. 156.24 lakhs will be reserved for subscription by the market maker to the issue (the “**Market Maker Reservation Portion**”). The Issue less Market Maker Reservation Portion i.e. Issue of 27,31,200 Equity Shares of face value of Rs. 10 each, at an issue price of Rs. 105 per Equity Share for cash, aggregating to Rs. 2867.76 lakhs is hereinafter referred to as the “**Net Issue**”. The Public Issue and Net Issue will constitute 26.47% and 25.10% respectively of the post- issue paid-up Equity Share capital of our Company.

E. OBJECTS OF THE ISSUE

Our Company intends to utilize the net Proceeds of the Issue to meet the following objects: -

Sr No.	Particulars	Amount (₹ in Lakhs)
1.	Funding of capital expenditure towards installation of new Plant & Machinery	404.55
2.	Repayment and/or pre-payment, in full or part, of certain borrowings availed by our Company;	1580.00
3.	General Corporate Purpose	725.51
	Total	2710.06

F. PRE-ISSUE SHAREHOLDING OF PROMOTERS AND PROMOTER GROUP

Our Promoters and Promoter Group collectively holds 80,00,000 Equity shares of our Company aggregating to 100.00% of the pre-issue paid-up Share Capital of our Company. Following are the details of the shareholding of the Promoters and Promoter Group, as on date of this Prospectus: -

Sr. No	Names	Pre IPO		Post IPO	
		Shares Held	% Shares Held	Shares Held	% Shares Held
	Promoters				

1.	Nitin Kumar Heda	3,999,800	50.00	3,999,800	36.76
2.	Prahladrai Ramdayal Heda	1,999,900	25.00	1,999,900	18.38
3.	Khushboo Manishkumar Heda	1,999,900	25.00	1,999,900	18.38
4.	Manish Kumar Heda	-	0.00	-	0.00
	Sub Total (A)	79,99,600	100.00	79,99,600	73.53
	Promoter Group				
5.	Akshaykumar Ramdayal Heda HUF	100	0.00	100	0.00
6.	Nitinkumar Akshaykumar Heda HUF	100	0.00	100	0.00
7.	Prahladrai Ramdayal Heda HUF	100	0.00	100	0.00
8.	Manishkumar Akshaykumar Heda HUF	100	0.00	100	0.00
	Sub Total (B)	400	0.00	400	0.00
	Grand Total (A+B)	80,00,000	100.00	80,00,000	73.53

G. SUMMARY OF FINANCIAL INFORMATION

Following are the details as per the restated financial statements for the financial years ended on March 31 2024, March 31, 2023 and March 31, 2022: -

Sr. No	Particulars	Amt. (Rs. in lakhs)		
		For the year ended		
		March 31, 2024	March 31, 2023	March 31, 2022
1.	Equity Share Capital	800.00	50.00	1,158.58
2.	Net Worth	2003.90	362.08	1,158.58
3.	Total Income	1,16,655.09	1,15,039.91	93,791.80
4.	Profit/(loss) after tax	890.36	560.27	426.03
5.	Earnings per Share (based on weighted average number of shares)	19.35	14.01	10.65
6.	Net Asset Value per Share (Based on Weighted Average Number of Shares)	43.55	9.05	28.96
7.	Total Borrowings (including current maturities of long term borrowings)	3,491.74	4,646.82	2,532.38

H. AUDITOR QUALIFICATIONS

There are no audit qualifications which have not been given effect in the Restated Financial Statements.

I. SUMMARY OF OUTSTANDING LITIGATIONS

Except as mentioned below, as on the date of Prospectus our Company are not involved in any legal proceedings.

Litigations filed by our Company: -

(Rs. in lakhs)

Nature of Cases	No. of Outstanding Cases	Amount in dispute/demanded to the extent ascertainable
Criminal Proceeding	2	5.26
Total	2	5.26

Litigations against the Company: -

(Rs. in lakhs)

Nature of Cases	No. of Outstanding Cases	Amount in dispute/demanded to the extent ascertainable
Direct Tax (TDS Default)	1	1.63
Indirect Tax (GST show cause notice, replied by Company but order awaited)	5	1563.03
Total	6	1564.66

For further details, please refer to the chapter titled "Outstanding Litigations and Material Developments" on page 195 of this Prospectus.

J. RISK FACTORS

For details on the risks involved in our business, please see the Chapter titled “*Risk Factors*” beginning on page 25 of this Prospectus.

K. SUMMARY OF CONTINGENT LIABILITIES

(Rs. in lakhs)

Particulars	For the financial year ended		
	March 31, 2024	March 31, 2023	March 31, 2022
Contingent liabilities in respect of:			
TDS Demands	1.63	0.00	0.00
GST Demand	1,492.51	0.00	0.00
Guarantees given on Behalf of the Company	222.02	222.02	0.00
Total	1,716.16	222.02	0.00

For further details, please refer to *Annexure-H - Contingent Liabilities* of the chapter titled “*Financial Information of the Company*” on page 175 of this Prospectus.

L. SUMMARY OF RELATED PARTY TRANSACTIONS

As required under Accounting Standard 18 "Related Party Disclosures" as notified pursuant to Company (Accounting Standard) Rules 2006, following are details of transactions during the year with related parties of the company as defined in AS 18.

i. List of Related Parties and Nature of Relationship:

Particulars	Name of Related Parties	Nature of Relationship
a) Key Management Personnel's / Related Party	Nitinkumar Akshaykumar Heda	Managing Director
	Prahladrai Ramdayal Heda	Chairman & Whole Time Director
	Khushboo Manishkumar Heda	Non-Executive Director
	Ronak Ashokbhai Mehta	Independent Director
	Jaimish Govindbhai patel	Independent Director
	Nikita Sharma	Company Secretary
	Manish Heda	Chief Financial Officer
b) Associate Concerns	Komal Heda	Wife of Nitin kumar Heda
	Heda ladmumari Prahladrai	Wife of Prahladrai Ramdayal Heda
c) Enterprises in which KMP/Relatives of KMP can exercise significant influence	Santram Metals And Alloys Private Limited	Nitin Kumar Heda having controlling interest
	Sunlite Aluminium Private Limited	Manish Heda having controlling interest
	Heda Sanghatan Seva Foundation	Prahladrai Ramdayal Heda having controlling interest
	Nitinkumar Akshaykumar Heda HUF	HUF of our KMP
	Heda Prahladrai Ramdayal (HUF)	HUF of our KMP
	Heda Akshaykumar Ramdayal (HUF)	HUF of our KMP's relative
	Manishkumar Akshaykumar Heda (HUF)	HUF of our KMP

(Amount in Rs. lakhs)

Nature of Transactions	Name of Related Parties	As at March 31, 2024	As at March 31, 2023	As at March 31, 2022
1. Partners Remuneration	Nitin Kumar Heda	0.00	0.00	84.00
	Prahladrai Ramdayal Heda	0.00	0.00	28.00
2. Directors Remuneration	Nitin Kumar Heda	90.00	66.00	0.00
	Prahladrai Ramdayal Heda	30.00	22.00	0.00
3. Interest	Akshaykumar Heda	0.00	0.23	18.22
	Heda Akshaykumar R HUF	0.00	0.09	5.17
	Manishkumar A Heda HUF	0.00	0.09	2.87
	Manish Kumar Heda	0.60	0.35	3.13
	Nitinkumar A Heda HUF	0.22	0.09	2.79
	Pratik Satishbhai Shah	0.00	0.00	0.99
	Reena P Heda	1.99	0.00	1.90
Khushboo Manishkumar Heda	44.26	51.30	0.00	

	Nitin Heda	47.95	74.91	0.00
	Prahladrai R Heda	28.27	29.25	0.00
	Prahladrai Ramdayal Heda HUF	0.22	0.00	0.00
	Shardakumari Heda	1.87	0.00	0.00
	Komal Heda	10.17	0.00	0.00
	Ladkumari Prahaladbhai Heda	1.84	0.00	0.00
3. Rent	Nitin Kumar Heda	16.80	16.80	9.60
4.Labour Contract	Akshaykumar Heda	0.00	0.00	10.08
5. Salary	Manish Kumar Heda	48.02	32.02	36.02
	Pratik Satishbhai Shah	0.00	3.22	4.22
6. Interest On Capital	Khushboo Manishkumar Heda	0.00	0.00	22.25
	Nitin Heda	0.00	0.00	14.22
	Prahladrai R Heda	0.00	0.00	21.50
7. Loan Received (Paid) during the Year to Related Parties	Akshaykumar Heda			
	Opening Balance	0.21	0.00	148.61
	Loan Received during the year	44.79	31.23	120.92
	Loan Paid during the year	-45.00	-31.02	-269.52
	Closing Balance	0.00	0.21	0.00
	Chandmal Somani			
	Opening Balance	0.00	0.00	2.70
	Loan Received during the year	0.00	0.00	0.00
	Loan Paid during the year	0.00	0.00	0.00
	Closing Balance	0.00	0.00	2.70
	Heda Akshaykumar R HUF			
	Opening Balance	7.58	0.00	37.97
	Loan Received during the year	61.24	11.09	21.17
	Loan Paid during the year	-68.82	-3.51	-59.15
	Closing Balance	0.00	7.58	0.00
	Heda Prahladrai R HUF			
	Opening Balance	7.58	0.00	26.98
	Loan Received during the year	0.20	15.09	18.93
	Loan Paid during the year	-7.78	-7.51	-45.91
	Closing Balance	0.00	7.58	0.00
	Komal Heda			
	Opening Balance	101.17	0.00	78.95
	Loan Received during the year	66.15	112.88	40.87
	Loan Paid during the year	-167.32	-11.71	-119.82
	Closing Balance	0.00	101.17	0.00
	LADKUMARI HEDA			
	Opening Balance	7.64	0.00	4.94
	Loan Received during the year	29.81	8.65	11.14
	Loan Paid during the year	-37.45	-1.01	-16.09
	Closing Balance	0.00	7.64	0.00
	Manishkumar A Heda HUF			
	Opening Balance	7.58	0.00	18.25
Loan Received during the year	0.20	11.09	19.87	
Loan Paid during the year	-7.78	-3.51	-38.12	
Closing Balance	0.00	7.58	0.00	
Manish Kumar Heda				
Opening Balance	5.31	0.00	44.79	
Loan Received during the year	58.24	10.35	35.04	
Loan Paid during the year	-63.55	-5.03	-79.83	
Closing Balance	0.00	5.31	0.00	
Nitinkumar A Heda HUF				
Opening Balance	7.58	0.00	18.13	
Loan Received during the year	0.20	11.09	18.79	
Loan Paid during the year	-7.78	-3.51	-36.92	

	Closing Balance	0.00	7.58	0.00
	Pratik Satishbhai Shah			
	Opening Balance	0.00	0.00	8.16
	Loan Received during the year	0.00	0.00	4.99
	Loan Paid during the year	0.00	0.00	-13.15
	Closing Balance	0.00	0.00	0.00
	Reena P Heda			
	Opening Balance	0.00	0.00	14.25
	Loan Received during the year	35.44	1.00	12.75
	Loan Paid during the year	-35.44	-1.00	-27.00
	Closing Balance	0.00	0.00	0.00
	Shardaben A Heda			
	Opening Balance	1.29	0.00	46.84
	Loan Received during the year	51.87	4.79	39.01
	Loan Paid during the year	-53.16	-3.50	-85.85
	Closing Balance	0.00	1.29	0.00
	Khushboo Manishkumar Heda			
	Opening Balance	758.58	745.92	0.00
	Loan Received during the year	48.33	95.10	0.00
	Loan Paid during the year	-806.91	-82.45	0.00
	Closing Balance	0.00	758.58	0.00
	Nitin Heda			
	Opening Balance	397.36	1,075.46	0.00
	Loan Received during the year	740.64	262.71	0.00
	Loan Paid during the year	-1,138.00	-940.82	0.00
	Closing Balance	0.00	397.36	0.00
	Prahladrai R Heda			
	Opening Balance	415.52	424.48	0.00
	Loan Received during the year	107.74	29.25	0.00
	Loan Paid during the year	-523.26	-38.21	0.00
	Closing Balance	0.00	415.52	0.00
8. Sales	Sunlite Aluminium Pvt Ltd	15.27	0.00	0.00
9. Purchase	Adarsh Impex	0.00	1,486.34	63.80
10. Rent Income	Sunlite Aluminium Pvt Ltd	18.00	0.00	0.00
11. Job work	Sunlite Aluminium Pvt Ltd	30.26	0.00	0.00

For further details, please refer to the “Annexure-J- Related Party Disclosures” of chapter titled “Financial Information of the Company” on page 176 of this Prospectus.

M. DETAILS OF FINANCING ARRANGEMENTS

There are no financing arrangements whereby the promoters, members of the promoter group, the directors of the issuer and their relatives have financed the purchase by any other person of securities of the issuer other than in the normal course of the business of the financing entity during the period of six months immediately preceding the date of this Prospectus.

N. WEIGHTED AVERAGE PRICE OF THE SHARES ACQUIRED BY PROMOTERS IN LAST ONE YEAR

Weighted average price at which the Equity Shares were acquired by our Promoters in last one year preceding the date of this Prospectus:

Sr. No.	Name of the Promoters	No. of Shares acquired in last one year	Weighted Average Price (in ₹)
1.	Nitin Kumar Heda	37,50,002	6.29
2.	Prahladrai Ramdayal Heda	18,75,001	6.29
3.	Khushboo Manishkumar Heda	18,75,001	6.29
4.	Manish Kumar Heda	-	NA

O. AVERAGE COST OF ACQUISITION OF SHARES FOR PROMOTERS

The average cost of acquisition of Equity Shares by our Promoters is set forth in the table below:

Sr. No.	Name of the Promoters	No. of Shares held	Average cost of Acquisition (in ₹)
1.	Nitin Kumar Heda	3,999,800	6.52
2.	Prahladrai Ramdayal Heda	1,999,900	6.52
3.	Khushboo Manishkumar Heda	1,999,900	6.52
4.	Manish Kumar Heda	-	NA

P. PRE IPO PLACEMENT

Our Company is not considering any pre-IPO placement of equity shares of the Company.

Q. EQUITY SHARES ISSUED FOR CONSIDERATION OTHER THAN CASH

Except as set out below, we have not issued Equity Shares for consideration other than cash in the last one year.

Date of Allotment	Number of Equity Shares	Face Value (Rs.)	Issue Price (Rs.)	Reasons for Allotment	Benefits Accrued to our Company	Name of Allottee	No. of Shares Allotted
January 18, 2024	35,00,000	10	Nil	Bonus Issue in the ratio of 7:1	Capitalization of Reserves & Surplus	Nitin Kumar Heda	17,50,000
						Prahladrai Ramdayal Heda	8,75,000
						Khushboo Manishkumar Heda	8,75,000
						Total	35,00,000

R. SPLIT/ CONSOLIDATION OF EQUITY SHARES

Our company has not done any split/consolidation/ subdivision of equity shares of the Company since incorporation.

S. EXEMPTION FROM COMPLYING WITH ANY PROVISIONS OF SECURITIES LAWS, IF ANY, GRANTED BY SEBI

As on date of the Prospectus, our Company has not availed any exemption from complying with any provisions of securities laws granted by SEBI.

SECTION III: RISK FACTORS

An investment in our Equity Shares involves a high degree of financial risk. Prospective investors should carefully consider all the information in the Prospectus, particularly the “**Financial Information of the Company**” and the related notes, “**Our Business**” and “**Management’s Discussion and Analysis of Financial Condition and Results of Operations**” on page 144, 98 and 185 respectively of this Prospectus and the risks and uncertainties described below, before making a decision to invest in our Equity Shares.

The risk factors set forth below are not exhaustive and do not purport to be complete or comprehensive in terms of all the risk factors that may arise in connection with our business or any decision to purchase, own or dispose of the Equity Shares. This section addresses general risks associated with the industry in which we operate and specific risks associated with our Company. Any of the following risks, individually or together, could adversely affect our business, financial condition, results of operations or prospects, which could result in a decline in the value of our Equity Shares and the loss of all or part of your investment in our Equity Shares. While we have described the risks and uncertainties that our management believes are material, these risks and uncertainties may not be the only risks and uncertainties we face. Additional risks and uncertainties, including those we currently are not aware of or deem immaterial, may also have an adverse effect on our business, results of operations, financial condition and prospects.

This Prospectus contains forward-looking statements that involve risks and uncertainties. Our actual results could differ materially from those anticipated in these forward-looking statements as a result of certain factors, including the considerations described below and elsewhere in this Prospectus. The financial and other related implications of risks concerned, wherever quantifiable, have been disclosed in the risk factors below. However, there are risk factors the potential effects of which are not quantifiable and therefore no quantification has been provided with respect to such risk factors. In making an investment decision, prospective investors must rely on their own examination of our Company and the terms of the Issue, including the merits and the risks involved. You should not invest in this Issue unless you are prepared to accept the risk of losing all or part of your investment, and you should consult your tax, financial and legal advisors about the particular consequences to you of an investment in our Equity Shares.

Materiality

The Risk factors have been determined on the basis of their materiality. The following factors have been considered for determining the materiality.

1. Some events may not be material individually but may be found material collectively.
2. Some events may have material impact qualitatively instead of quantitatively.
3. Some events may not be material at present but may be having material impact in future.

Note:

The risk factors as envisaged by the management along with the proposals to address the risk if any. Unless specified or quantified in the relevant risk factors below, we are not in a position to quantify the financial implication of any of the risks described in this section.

In this Prospectus, any discrepancies in any table between total and the sums of the amount listed are due to rounding off. Any percentage amounts, as set forth in “**Risk Factors**” on page 25 and “**Management Discussion and Analysis of Financial Condition and Results of Operations**” on page 185 of this Prospectus unless otherwise indicated, has been calculated on the basis of the amount disclosed in the “**Restated Financial Statements**”.

INTERNAL RISK FACTORS

1. ***Our production costs are vulnerable to fluctuations in raw material prices, especially Copper scrap. Currently, we haven't secured any long-term supply agreements for the raw materials we need.***

The raw material consumption contribution is 96.36 %, 97.06 % and 97.07 % of revenue from manufacturing activities for the financial year ended March 31, 2024, 2023 and 2022 respectively. The industry in which we operate is exposed to fluctuations in the prices of copper scrap and we may be unable to control factors affecting the price directly or indirectly at which we procure our raw material, particularly as we typically do not enter into any long-term supply agreements with our suppliers and our major requirement is met in the spot market. We may at times also face the risks associated with compensating for or passing on such increase in our cost of production on account of such fluctuations in prices to our customers. Particularly, we face the risk of our products becoming unaffordable for a particular segment of demography, if we pass on the increase in the cost of production to our customers through a corresponding increase in the price of our products in order to maintain our historical margins. Upward fluctuations in the prices of raw material may thereby affect our margins directly or indirectly and thereby have a direct bearing on our profitability, resulting in a material adverse effect on our business, financial condition and results of operations.

In addition, any restrictions, either from the Central or state governments, or from countries which we import from, on the import of our raw materials or any adverse change in policies by India or other countries, in terms of tariff and non-tariff barriers, may adversely affect our business, prospects, financial condition and results of operations. There can be no assurance that such restrictions/ regulations would not be made more stringent which would consequently restrict our ability to import raw materials from other jurisdictions. Further, there can be no assurance that, under these circumstances, we will be successful in identifying alternate suppliers for raw materials or we will be able to source the raw materials at favourable terms in a timely manner. Any restriction on import of raw materials could have an adverse effect on our ability to deliver products to our customers, business and results of operations.

2. We are primarily dependent upon few key suppliers within limited geographical location for procurement of raw materials. Any disruption in the supply of these raw materials due to fluctuations in the prices could have a material adverse effect on our business operations and financial conditions.

We procure a large portion of our raw materials from a few key suppliers, with whom we do not have any long-term supply contracts and therefore, we cannot assure you that we shall always have a steady supply of raw materials at prices favourable to us. For the Fiscals 2024, 2023 and 2022 purchases from our top ten suppliers amounted to Rs. 57,507.17 Lakhs, Rs. 51,255.52 Lakhs and Rs. 42,878.54 Lakhs respectively which represented 52.03%, 45.58% and 46.59% of our total raw material purchases.

Further, we source major portion of our raw materials requirement indigenously. Major portion of our purchases of raw materials for the F.Y ending 2024, 2023 & 2022 is from the state of Gujarat which is 46.83%, 66.91% and 75.72% of the total purchases of raw material, respectively, for the said period. We are also exposed to foreign exchange related risks as some portion of our expenditure is denominated in foreign currencies. Our total import purchases for the F.Y. ending 2023-24 are Rs. 30,172.67 Lakhs which comprises of 27.31% of total purchases for the said period.

The exchange rate between the Indian Rupee and foreign currencies, primarily the USD, has fluctuated in the past and may fluctuate in future also, which may affect our results of operations. Depreciation of the Indian Rupee against the USD may adversely affect our results of operations by increasing the cost of the raw materials we import or any proposed capital expenditure in foreign currencies. Although we generally seek to pass exchange rate fluctuations to our customers through increases in our prices, there can be no assurance that we will be able to do so immediately or fully, which could adversely affect our business, financial condition, results of operations and cash flows. Thus, our global operations expose us to foreign exchange rate risks, arising primarily from our payables and import of goods. There can be no guarantee that such fluctuations will not affect our financial performance in the future as we continue to expand our operations globally.

Inadequate supply of raw material caused either by a sudden change in the prices or imposition of any new taxes or loss of any of our existing major vendors for any reason could have a material adverse effect on our business operations and profitability. Further, any materially adverse social, political or economic development, civil disruptions, or changes in the policies of the state government or state or local governments of Gujarat may affect continuing operations at our manufacturing unit and result in significant loss due to an inability to meet customer contracts and production schedules, which could materially affect our business reputation within the industry. If we cannot fully offset increases in the cost of raw materials, through increases in the prices for our products, we would experience lower margins and profitability, which would have a material adverse effect on our financial condition and results of operations. Our ability to remain competitive, maintain costs and profitability depend, in part, on our ability to source and maintain a stable and sufficient supply of raw materials at acceptable prices.

Further, discontinuation of such supply or a failure of these suppliers to adhere to the delivery schedule or the required quality could hamper our production schedule and therefore affect our business and results of operations. There can be no assurance that demand, capacity limitations or other problems experienced by our suppliers will not result in occasional shortages or delays in their supply of raw materials. If we were to experience a significant or prolonged shortage of raw materials from any of our suppliers, and we cannot procure the raw materials from other sources, we would be unable to meet our production schedules for our key products and to deliver such products to our customers in a timely manner, which would adversely affect our sales, margins and customer relations. Any delay in the supply or delivery of raw materials to us by our suppliers in may in turn delay our process of manufacture and delivery of products to our customers and this may have an adverse effect on our business, cash flows and results of operations. Additionally, our inability to predict market conditions may result in us placing supply orders for inadequate quantities of such raw materials. Therefore, we cannot assure you that we will be able to procure adequate supplies of raw materials in the future, as and when we need them and on commercially acceptable terms.

3. We generate our major portion of sales from our operations in certain geographical regions and any adverse developments affecting our operations in these regions could have an adverse impact on our revenue and results of operations.

We generate major domestic sales from the State of Gujarat. For the financial year ended March 31, 2024, March 31, 2023 & March 31, 2022 we derived major portion of our revenue from the state of Gujarat i.e. 45.73%, 44.58% and 38.11% of total revenue from

operations, respectively. Further, our revenue from top-5 states for the financial year ended March 31, 2024, March 31, 2023 & March 31, 2022 accounted for 92.80%, 93.27% and 92.58% of total revenue from operations, respectively.

We carry our entire manufacturing operations from our manufacturing unit located at Dantali, Kheda in Gujarat. Due to the geographical concentration of our manufacturing operations at Gujarat, our operations are prone to local, regional and environmental factors. Any materially adverse social, political or economic development, civil disruptions, or changes in the policies of the state government or state or local governments, may require a modification of our business strategy, or require us to incur significant capital expenditure or suspend our operations. Any such adverse development affecting continuing operations at our manufacturing unit could result in significant loss due to an inability to meet customer contracts and production schedules, which could materially affect our business reputation within the industry. The occurrence of or our inability to effectively respond to, any such events or effectively manage the competition in the region, could have an adverse effect on our business, results of operations, financial condition, cash flows and future business prospects.

Further, as we enter into new markets and geographical areas, we are likely to compete with not only national players, but also the local players, who might have an established local presence, and are more familiar with local business practices and have stronger relationships with local distributors, dealers, relevant government authorities, suppliers or are in a stronger financial position than us, all of which may give them a competitive advantage over us. Our inability to expand into other areas may adversely affect our business prospects, financial conditions and results of operations. While our management believes that the Company has requisite expertise and vision to grow and mark its presence in other markets going forward, investors should consider our business and prospects in light of the risks, losses and challenges that we face and should not rely on our results of operations for any prior periods as an indication of our future performance.

4. *We have very short span of operating history as company.*

Our company was incorporated on August 04, 2022 as a private limited company in the name of Sunlite Alucop Private Limited when our company took over the running business of 'M/s Sunlite Industries' which was a partnership concern with Prahladrai Ramdayal Heda, Nitin Kumar Heda and Khushboo Manishkumar Heda as partners and carrying on the business of manufacturing copper rods, wires, bars, strips etc. Subsequently, in January 2024, the company changed its name from Sunlite Alucop Private Limited to Sunlite Recycling Industries Private Limited. Our limited operating history as a company may adversely affect our ability to implement our growth strategies, and may make it difficult for you to evaluate our past performance and future prospects in connection with any investment in the Equity Shares. Prospective investors should accordingly consider our future prospects in light of the risks and the challenges encountered by a company with a limited operating history.

We cannot guarantee our ability to effectively navigate the challenges, uncertainties, costs, and difficulties we may encounter, nor can we ensure the successful achievement of our objectives. The limited duration of our operational history further complicates the prediction of our future prospects and financial performance.

5. *Our top 10 and top 5 customers contribute majority of our revenues from operations for the year ended March 31, 2024, 2023 and 2022. Any loss of business from one or more of them may adversely affect our revenues and profitability.*

Our top 10 and top 5 customers contributed 40.00%, 31.22% and 41.96% respectively for the FY ending 2024, 2023 & 2022 and 28.54%, 20.57% and 30.94% respectively for the FY ending 2024, 2023 & 2022 of our revenues from operations based on restated financial statements. However, our top customers may vary from period to period depending on the demand and thus the composition and revenue generated from these clients might change as we continue to add new customers in normal course of business. Since our business is concentrated among relatively few significant customers, we could experience a reduction in our results of operations, cash flows and liquidity if we lose one or more of these customers or the amount of business we obtain from them is reduced for any reason, including but not limited on account of any dispute or disqualification.

We have also experienced a delay in receipt of payment from various parties with whom we have conducted business. Accordingly, we cannot assure you that the customers which contribute to the major part of our revenue stream will pay us the amounts due to us on time, or at all. In the event any of our significant customers fail to fulfil their respective obligations, our business, financial condition and results of operations would be adversely affected. While we believe we have maintained good and long term relationships with our customers. However, there can be no assurance that we will continue to have such long term relationship with them. We cannot assure that we shall generate the same quantum of business, or any business at all, from these customers, and loss of business from one or more of them may adversely affect our revenues and profitability.

In addition, we have not entered into long term agreements with our customers and the success of our business is accordingly significantly dependent on maintaining good relationship with them. The loss of one or more of these significant customers or a reduction in the amount of business we obtain from them could have an adverse effect on our business, results of operations, financial condition and cash flows.

Further, there is no guarantee that we will retain the business of our existing key customers or maintain the current level of business with each of these customers. In order to retain some of our existing customers, we may also be required to offer terms to such customers which may place restraints on our resources. Additionally, our revenues may be adversely affected if there is an adverse change in any of our customers' supply chain strategies or a reduction in their outsourcing of products we offer, or if our customers decide to choose our competitors over us or if there is a significant reduction in the volume of our business with such customers.

We cannot assure you that we will be able to maintain historic levels of business and/or negotiate and execute long term contracts on terms that are commercially viable with our significant customers or that we will be able to significantly reduce customer concentration in the future. Further, the sales volume may vary due to our customers' attempts to manage their inventory, market demand, product and supply pricing trends, change in customer preferences etc., which may result in decrease in demand or lack of commercial success of our products, which could reduce our sales and adversely affect our business, cash flows, results of operations and financial condition.

6. Copper wires can be substituted by aluminium wires due to the lower cost and weight of metal which may pose a threat to the core business of our Company impacting the overall profitability.

We are engaged into manufacturing of copper rods, copper wires (i.e. copper earthing wires, copper conductors & copper submersible wires) and copper strips. Copper is being used in electric wiring since years due to good electricity conductivity. Copper possesses various qualities such as high tensile strength, high ductility, excellent creep and corrosion resistance, high thermal conductivity, solder ability and ease in installation. Thus, the Copper wires are widely used in auto electrical, transformers, compressors and various types of other electrical equipment.

The potential substitution of copper wires with aluminum wires poses a significant threat to the core business of our Company, which primarily deals with copper-based products. This substitution is driven by the lower cost and weight of aluminum compared to copper. However, there is an increasing trend of using aluminium wires in place of copper wires in both household and industry applications. Aluminium is a common alternative to copper especially in long distance lines where the lower cost and weight of aluminium offer a significant advantage over copper. Moreover, larger aluminium wiring requires less support compared to copper wiring which makes it a good choice for industrial purposes.

For our Company, this substitution trend represents a direct challenge to our traditional business model and revenue streams. If customers increasingly opt for aluminum wires over copper ones, it could lead to a decline in demand for our copper-based products. Thus, with the development of technology and consecutive improvements in the production of aluminium, it has emerged as a cheap substitute to copper, creating a possible threat to the business undertaken by our company. This, in turn, may negatively impact our overall profitability, as our core business relies heavily on the sale of copper rods, wires, bars, strips, and related items.

7. Majority of our revenue is dependent on single business segment i.e. copper rods. An inability to anticipate or adapt to evolving upgradation of products or inability to ensure product quality or reduction in the demand of such products may adversely impact our revenue from operations and growth prospects.

Majority of our revenue is dependent on single business segment i.e. copper rods, which accounted for 89.66%, 89.30% & 88.79% of our total revenue from operations, respectively for the F.Y ending March 31, 2024, March 31, 2023 & March 31, 2022. Our continued reliance on single business segment for substantial portion of our revenue exposes us to risks, including but not limited to, reduction in the demand of the products in the particular segment in the future; increased competition from regional and national players; the invention of superior and cost-effective technology; fluctuations in the price and availability of the raw materials; changes in regulations and import duties and the general economic conditions. Any occurrences of such event could significantly reduce our revenues, thereby materially adversely affecting our results of operations and financial condition.

8. Ours is a high volume-low margin business. Any disruption in our turnover or failure to regularly grow the same may have a material adverse effect on our business, results of operations and financial condition.

Ours is a high volume-low margin business. Our financial operations are largely dependent on the volume of the business we generate which will add to profits in absolute terms. We need to generate higher volume in terms of quantity to increase our profitability to make our products commercially feasible. Our inability to regularly grow our turnover and effectively execute our key business processes could lead to lower profitability and hence adversely affect our operating results, debt service capabilities and financial conditions. Due to the nature of the products we sell, we may not be able to charge higher margins on our products. Hence, our business model is heavily reliant on our ability to effectively grow our turnover and manage our key processes including but not limited to procurement of raw material, timely sales execution and continuous cost control.

Our PBT and PAT based on restated financial statements as follows:

(₹ in lakhs except percentage)

Particulars	For the financial year ended		
	March 31, 2024	March 31, 2023	March 31, 2022
Revenue from Operations	1,16,627.09	115,018.88	93,719.32
PBT	1,180.01	755.49	564.53
PBT Margin(%)	1.01%	0.66%	0.60%
PAT	890.36	560.27	426.03
PAT Margin (%)	0.76%	0.49%	0.45%

9. We do not own the registered office & manufacturing unit and marketing office from which we carry out our business activities. In case of nonrenewal of rent agreements or dispute in relation to use of the said premise, our business and results of operations can be adversely affected.

Our registered office & manufacturing unit and marketing office, from which we carry out our business activities, are being taken by us on rent. In the event of termination/non-renewal of said agreements, we may be required to vacate the said premises which may cause disruption in our inventory management, corporate affairs and business and impede our effective operations which could temporarily impact on our business operations until we get suitable alternative premises. For details on the duration of existing rent/lease agreements for our premises, please refer to the section titled “**Our Business**” beginning on page 98 of this Prospectus.

There can be no assurance that we will, in the future, be able to renew the agreements for the existing locations on same or similar terms, or will be able to find alternate locations for the offices on similar terms favourable to us, or at all. We may also fail to negotiate the renewal of our rent agreements for our premises, either on commercially acceptable terms or at all, which could result in increased rental rates for subsequent renewals or searching of new premises, affecting our financial condition and operations. In the event that the rent agreement is terminated or they are not renewed on commercially acceptable terms, we may suffer a disruption in our manufacturing operations which could materially and adversely affect our business, financial condition and results of operations.

10. Our historical performance is not indicative of our future growth or financial results and we may not be able to sustain our historical growth rates.

Our business has experienced significant growth in prior periods. Our revenue from operations has increased from Rs. 93,719.32 Lakhs in Financial Year 2021-22 to Rs. 1,15,018.88 Lakhs and Rs. 1,16,627.09 Lakhs in Financial Years 2022-23 and 2023-24 respectively.

However, we acknowledge the dynamic nature of our industry and the challenges that come with sustaining such remarkable growth rates. While our past performance reflects our ability to capitalize on market opportunities, we cannot provide absolute assurance regarding the continuous maintenance of these elevated levels of revenue growth. In the copper manufacturing industry, we operate amidst competition from both organized and unorganized players with a widespread presence across various regions in India. These competitors offer products similar to ours, potentially gaining a competitive edge in aspects such as pricing, durability, product quality, user experience, operational efficiency, timely delivery, and reliability. Keeping pace with the ever-changing technology landscape in the industry is crucial, and our ability to adapt will significantly impact our competitive standing.

Additionally, several of our strategic initiatives are currently in their nascent stages. While initial success is a possibility, the long-term success of these initiatives is not guaranteed. The inherent uncertainties in the early stages of strategic endeavours necessitate a cautious approach, and we cannot assure sustained success without potential challenges and adjustments along the way. We remain vigilant and adaptable, ready to navigate the evolving landscape and optimize our strategies for long-term success.

11. Our Business is dependent on our manufacturing unit. Any disruption, breakdown or failure of machinery, disruption to power sources or any temporary shutdown of our manufacturing unit, may have a material adverse effect on our business, results of operations, financial condition and cash flows.

We have a manufacturing unit at Dantali, Kheda in Gujarat, which are subject to various operating risks, including those beyond our control, such as the breakdown and failure of equipment or industrial accidents and severe climate conditions and natural disasters. Any significant malfunction or breakdown of our machinery may entail significant repair and maintenance costs and cause delays in our operations. If we are unable to repair breakdown of machinery in a timely manner or at all, our operations may need to be suspended until we procure new machinery to replace the same. In addition, we may be required to carry out planned shutdowns of our facilities for cleaning and maintenance, statutory inspections and testing, or may shut down certain facilities for capacity expansion and equipment upgrades.

Obsolescence, destruction, theft or breakdowns of our machineries may significantly increase our machineries purchase cost and the depreciation of our plants and machineries, as well as change the way our management estimates the useful life of our plants and

machineries. In such cases, we may not be able to acquire new plants or machineries or repair the damaged plants or machineries in time or at all. Some of our major machineries or parts may be costly to replace or repair. We may experience significant price increases due to supply shortages, inflation, transportation difficulties or unavailability. Such obsolescence, destruction, theft, breakdowns, repair or maintenance failures or price increases may not be adequately covered by the insurance policies availed by our Company and may have an effect on our business, cash flows, financial condition and results of operations.

Although we have not experienced any significant disruptions at our manufacturing unit in the past, we cannot assure you that there will not be any disruptions in our operations in the future. Our inability to effectively respond to such events and rectify any disruption, in a timely manner and at an acceptable cost, could lead to the slowdown or shut-down of our operations for limited time or under-utilization of our manufacturing unit, which in turn may have an adverse effect on our business, results of operations and financial condition.

12. Inventories and trade receivables form a major part of our current assets. Failure to manage our inventory and trade receivables could have an adverse effect on our net sales, profitability, cash flow and liquidity.

Our Company's business is working capital intensive and hence, inventories and trade receivables form a major part of our current Assets. We are a manufacturing company, and, at all points of time, a certain portion of our assets comprises of an inventory of raw materials, work in progress products and finished products. Maintaining sufficient inventory of raw materials is critical for our operations including as a buffer against any supply disruptions. Any failure on our part to effectively manage our inventory of raw materials and finished products in response to changing market scenario may have an adverse effect on our financial condition and may even lead to loss of business and increase the costs of our operations. During the FY 2023-24, 2022-23 and 2021-22 our inventories were Rs. 2,969.56 lakhs, Rs. 3,875.67 lakhs and Rs. 2,404.54 Lakhs respectively.

To effectively manage our trade receivables, we must be able to accurately evaluate the credit worthiness of our customers and ensure that suitable terms and conditions are given to them in order to ensure our continued relationship with them. However, if we fail to accurately evaluate the credit worthiness of our customers, it may lead to bad debts, delays in recoveries and / or write-offs which could lead to a liquidity crunch, thereby adversely affecting our business and results of operations. During the FY 2023-24, FY 2022-23, and 2021-22 our trade receivables Rs. 1,422.40 Lakhs, Rs. 1,167.75 Lakhs and Rs. 505.35 Lakhs respectively.

We may be subject to working capital risks due to delays or defaults in payment by clients, which may restrict our ability to procure raw materials and make payments when due. In addition, any delay or failure on our part to supply the required quantity or quality of products, within the time stipulated by our agreements, to our customers may in turn cause delay in payment or refusal of payment by the customer. Such defaults/delays by our customers in meeting their payment obligations to us may have a material effect on our business, financial condition and results of operations. A liquidity crunch may also result in case of increased working capital borrowings and, consequently, higher finance cost which will adversely impact our profitability.

13. We are subject to strict quality requirements and are consequently required to incur significant expenses to maintain our product quality. Any failure to comply with such quality standards may lead to cancellation of existing and future orders which may adversely affect our reputation, financial conditions, cash flows and results of operations.

Quality of our product is very important for our customers and their brands equity. All our products go through various quality checks at various stages. We supply copper products covering a variety of applications for the domestic, industrial and automobile segments each of which have different product specifications. Our Company is committed to provide quality products to our customers and in this relation has also received various quality accreditations including ISO 9001:2015 for our products. Our Company ensures that its products are tested for various application tests such as sample test, performance, durability, product safety etc., in line with applicable standards. Failure of our products to meet prescribed quality standards may result in rejection and reworking and replacement of product. Any failure on our part to successfully maintain quality standards for our products may affect our business and operations.

14. There are outstanding legal proceedings involving our Company. Any adverse decisions could impact our cash flows and profit or loss to the extent of demand amount, interest and penalty, divert management time and attention, consume financial resources in their defence or prosecution, affect our reputation, standing and future business and have an adverse effect on our business, prospects, results of operations and financial condition.

There are outstanding legal proceedings involving our Company. These proceedings are pending at different levels of adjudication before various courts (including Supreme Court and High Court), tribunals, enquiry officers and appellate tribunals. For details, see "Outstanding Litigation and Material Developments" beginning on page 195 of this Prospectus. A brief detail of such outstanding litigations as on the date of this Prospectus, with the amount involved, to the extent quantifiable are as follows:

Litigations filed by our Company: -*(Rs. in lakhs)*

Nature of Cases	No. of Outstanding Cases	Amount in dispute/demanded to the extent ascertainable
Criminal Proceeding	2	5.26
Total	2	5.26

Litigations against the Company: -*(Rs. in lakhs)*

Nature of Cases	No. of Outstanding Cases	Amount in dispute/demanded to the extent ascertainable
Direct Tax (TDS Default)	1	1.63
Indirect Tax (GST show cause notice, replied by Company but order awaited)	5	1563.03
Total	6	1564.66

There can be no assurance that these litigations will be decided in favour of our Company and consequently it may divert the attention of our management and Promoters and waste our corporate resources and we may incur significant expenses in such proceedings and may have to make provisions in our financial statements, which could increase our expenses and liabilities. If such claims are determined against us, there could be a material adverse effect on our reputation, business, financial condition and results of operations, which could adversely affect the trading price of our Equity Shares.

15. Our operations involve melting of copper scrap in the furnaces which can be extremely dangerous and any accident, could cause serious injury to people or property which may adversely affect our production schedules, costs, sales and ability to meet customer demand.

Our operations require individuals to work under potentially dangerous circumstances, with flammable materials as a significant portion of our business involves melting of copper scrap in the hot refining section. Despite compliance with requisite safety requirements and standards, our operations are subject to significant hazards, including:

- explosions
- fires
- mechanical failures and other operational problems
- inclement weather and natural disasters
- discharges or releases of hazardous substances, chemicals or gases; and
- other environmental risks.

Although we employ safety procedures during the melting of copper in the furnaces and maintain what we believe to be adequate insurance, there is a risk that any hazard may result in personal injury to our employees or other persons, destruction of property or equipment, environmental damage, etc. may lead to suspension of our operations and/or imposition of civil or criminal liabilities. The loss or shutting down of our facilities could disrupt our business operations and adversely affect our results of operations, cash flows, financial condition and reputation. We could also face claims and litigation in India, filed on behalf of persons alleging injury predominantly as a result of occupational exposure to hazards at our manufacturing unit, the outcome of which is difficult to assess or quantify, and the cost to defend such litigation could be significant. These claims and lawsuits, individually or in the aggregate, may be resolved against us inflicting negative publicity and consequently, our business, cash flows, results of operations and financial condition could be adversely affected.

In particular, if operations at our manufacturing unit were to be disrupted as a result of any significant workplace accident, fire, explosion or other connected reasons, our financial performance may be adversely affected as a result of our inability to meet customer demand or committed delivery schedules for our products. Interruptions in production may also increase our costs and reduce our sales, and may require us to make substantial capital expenditures to remedy the situation or to defend litigation that we may become involved in as a result, which may negatively affect our profitability, business, reputation, financial condition, results of operations, cash flows and prospects.

16. The Company has not placed orders of plant & machinery for our proposed object as specified in the Objects of the Issue. Any delay in placing orders, procurement of plant & machinery may delay our implementation schedule and may also lead to increase in price of these plant & machinery and equipments, further affecting our revenue and profitability.

We intend to use a part of the Net Proceeds towards funding of capital expenditure towards purchase of additional plant and machinery for usage in the existing manufacturing unit which will be used for manufacturing of copper strips. For further information, refer “*Objects of the Issue*” on page 70 of this Prospectus. Our expansion plans remain subject to the potential problems and uncertainties including cost overruns or delays. Problems that could adversely affect our expansion plans include increased costs of equipment, inadequate performance of the equipment and machinery to be installed at our manufacturing unit, delays in completion, the possibility of unanticipated future regulatory restrictions, delays in receiving governmental, statutory and other regulatory approvals, incremental pre-operating expenses, taxes and duties, interest and finance charges, working capital margin and other external factors which may not be within the control of our management. There can be no assurance that the proposed expansions will be completed as planned or on schedule, and if they are not completed in a timely manner, or at all, our budgeted costs may be insufficient to meet our proposed capital expenditure requirements. If our actual capital expenditures significantly exceed our budgets, or even if our budgets were sufficient to cover these projects, we may not be able to achieve the intended economic benefits of these projects, which in turn may materially and adversely affect our financial condition, results of operations, cash flows, and prospects. There can be no assurance that we will be able to complete the aforementioned expansion and additions in accordance with the proposed schedule of implementation and any delay could have an adverse impact on our growth, prospects, cash flows and financial condition.

17. Under-utilization of our manufacturing capacities and an inability to effectively utilize our existing manufacturing capacities could have an adverse effect on our business, future prospects and future financial performance.

Our capacity utilization levels are dependent on our ability to carry out uninterrupted operations at manufacturing facilities as well as on the market demand of the products sold by us. Among others, the capacity utilization also depends upon the availability of raw materials, labour, industry/ market conditions and procurement practice followed by our customers. For the Fiscals 2024, 2023 and 2022, our overall capacity utilization is detailed below:

Particulars	For the financial year ended		
	FY 2021-22	FY 2022-23	FY 2023-24
COPPER RODS			
Installed Capacity (MT)	14180.00	16580.00	16580.00
Actual Production (MT)	11497.25	14426.36	14455.23
Capacity Utilization (in %)	81.08%	87.01%	87.18%
COPPER WIRES			
Installed Capacity (MT)	1900.00	1900.00	1900.00
Actual Production (MT)	917.43	1178.23	1066.57
Capacity Utilization (in %)	48.29%	62.01%	37.23%
COPPER STRIPS			
Installed Capacity (MT)	720.00	720.00	720.00
Actual Production (MT)	377.02	234.69	312.58
Capacity Utilization (in %)	52.36%	32.60%	43.41%
TOTAL CAPACITY UTILIZED			
Total Installed Capacity (MT)	16800.00	19200.00	19200.00
Actual Production (MT)	12791.7	15839.28	15834.38
Capacity Utilization (in %)	76.14%	82.50%	82.47%

As certified by Krishnakant A. Pandat, Regd. Engineer, through certificate dated August 03, 2024.

In the event we are unable to achieve considerable capacity utilization of our current manufacturing facility, it would result in operational inefficiencies which could have a material adverse effect on our business, results, financial condition and future prospects. Under-utilization of our manufacturing capabilities over extended periods, or significant under-utilization in the short-term, could materially and adversely impact our business, growth prospects and future financial performance.

18. Our Group Company i.e. Sunlite Aluminium Private Limited operate in the similar line of business as us, which may lead to conflict of interest.

Our Group company i.e. Sunlite Aluminium Private Limited, is in the similar line of business as of our Company. Hence, we may have to compete with our Group Company for business, which may impact our business, financial condition and results of operations. We cannot assure that our Promoters who have common interest in said company will not favour the interest of said company. As a result, conflicts of interests may arise in allocating business opportunities amongst our Company and this group company in circumstances where our respective interests’ conflict. In cases of conflict, our Promoter may favour this company and there can be no assurance that our Promoters or members of the Promoter Group will not compete with our existing business or any future business that we may undertake or that their interests will not conflict with ours. Given that the Group Company manufactures aluminum rods while our focus is on copper rods, there's inherent competition within the Group itself.

However, our Company will ensure necessary procedures and practices as permitted by laws and regulatory guidelines to address situations of conflict of interest as and when they arise. Any such present and future conflicts could have a material adverse effect on our reputation, business, results of operations and financial condition which may adversely affect our profitability and results of operations. For further details, see “*Our Group Companies*” and *Annexure -J - Related Party Transactions*” under Section titled “*Financial Information of the Company*” on page 204 and 176 respectively of this Prospectus.

19. Our Contingent Liability and Commitments could affect our financial position.

As on March 31, 2024, we had Contingent Liability of Rs 1716.16 lakhs, which have not been provided in our financial statements and which could affect our financial position. For further details, please refer to *Annexure-H – Contingent Liabilities* in the chapter titled “*Financial Information of the Company*” on page 175 of this Prospectus.

(₹ in lakhs)

Particulars	For the financial year ended		
	March 31, 2024	March 31, 2023	March 31, 2022
Contingent liabilities in respect of:			
TDS Demands	1.63	0.00	0.00
GST Demand	1,492.51	0.00	0.00
Guarantees given on Behalf of the Company	222.02	222.02	0.00
Total	1,716.16	222.02	0.00

20. We have significant working capital requirements and operate on high debt to equity ratio and if we are unable to secure adequate working capital loans on commercially reasonable terms it could have a material adverse effect on our business, financial condition and results of operations.

Our business requires a substantial amount of working capital, primarily to finance our inventory, including, the purchase of raw materials. Moreover, we may need substantial working capital for expansion of our business. Most of this working capital requirement is met through bank loans, particularly the Cash Credit facilities and working capital term loans. Such financing has resulted into a high debt to equity ratio for the company. Our inability to obtain and/or maintain sufficient cash flow, credit facilities and other sources of funding, in a timely manner, or at all, to meet our working capital requirements or to pay our debts, could adversely affect our financial condition and results of operations.

21. Our insurance coverage may not be adequate to protect us against certain operating hazards and this may have a material adverse effect on our business.

Our operations are subject to accidents which are inherent to any business such as risks of employee accidents, fire, earthquakes, flood and other force majeure events, acts of terrorism and explosions including accidents that may cause injury and loss of life, severe damage to and the destruction of property and equipment and environment. We have taken National Bharat Sookshma Udyam Suraksha Policy i.e. Standard Fire & Special Perils Insurance Policy from National Insurance for our Registered office & manufacturing unit which provide insurance against loss from fire, explosion, lighting, earthquake, volcanic eruptions, riots, strike, malicious damage etc. We have also taken Marine Cargo Open Policy Insurance from National Insurance which covers expenses and financial liabilities that are incurred in the transportation of goods and other items along with Vehicle Insurance policy from Future Generali total insurance solutions and Employees compensation insurance from National Insurance. While we believe that we maintain insurance coverage in adequate amounts consistent with size of our business, our insurance policies do not cover all risks, specifically risks such as cash in transit, group personal accident or mediclaim policy. Failure to effectively cover ourselves against the associated risks may potentially lead to material losses. There can be no assurance that our insurance policies will be adequate to cover the losses/ damages suffered or that such insurance coverage will continue to be available on reasonable terms or will be available in sufficient amounts to cover one or more large claims, or that the insurer will not disclaim coverage as to any future claim. If we suffer a significant uninsured loss or if insurance claim in respect of the subject matter of insurance is not accepted or any insured loss suffered by us significantly exceeds our insurance coverage, our business, financial condition and results of operations may be materially and adversely affected.

22. Our Group Company have incurred losses in past and any operating losses in the future could adversely affect the results of operations and financial conditions of our group company.

Our Group Company i.e. Sunlite Aluminium Private Limited, incorporated in August 2022, has incurred loss in F.Y 2022-23 for an amount of Rs.12.02 lakhs. Further, our group company also have a negative networth of Rs. 11.02 lakhs in F.Y. 2022-23. Any operating losses could adversely affect the overall operations of the group and financial conditions and also divert the attention of the management and promoter towards the group company which could have an adverse effect on our operations and financials. For more information, regarding the Company, please refer chapter titled “*Our Group Companies*” beginning on page 204 of this Prospectus.

23. Our Company had negative operating cash flow in recent fiscals, details of which are given below. Sustained negative cash flow could adversely impact our business, financial condition and results of operations.

The detailed break up of operating cash flows is summarized in below mentioned table and our Company has reported negative operating cash flow. Sustained negative cash flow could adversely impact our business, financial condition and results of operations.

(₹ in lakhs)

Particulars	For the financial year ended		
	March 31, 2024	March 31, 2023	March 31, 2022
Net Cash flow from Operating Activities	1,128.99	238.16	(787.74)
Net Cash flow from Investing Activities	(173.16)	(324.60)	(228.83)
Net Cash flow from Financing Activities	(1,151.71)	284.89	640.57

Cash flow of a company is a key indicator to show the extent of cash generated from operations to meet capital expenditure, pay dividends, repay loans and make new investments without raising finance from external resources. If we are not able to generate sufficient cash flows in future, it may adversely affect our business and financial operations.

24. We require certain approvals, licenses, registrations and permits to operate our business, and failure to obtain or renew them in a timely manner or maintain the statutory and regulatory permits and approvals required to operate our business may adversely affect our operations and financial conditions.

We require certain statutory and regulatory permits, licenses and approvals to operate our business. We believe that we have obtained requisite permits and licenses which are adequate to run our business, however we cannot assure that there is no other statutory/regulatory requirement which we are required to comply with. Further, some of these approvals are granted for fixed periods of time and need renewal from time to time. We are required to renew such permits, licenses and approvals. There can be no assurance that the relevant authorities will issue any of such permits or approvals in time or at all. Failure by us to renew, maintain or obtain the required permits or approvals in time may result in the interruption of our operations and may have a material adverse effect on our business, financial condition and results of operations.

Also, our Company is in the process of making application for change in name in all the permits, licenses and approvals, which are under Company's former name. For details regarding pending approvals, please refer to section titled "**Government and Other Approvals**" beginning on page 199 of the Prospectus. There can be no assurance that the relevant authorities will issue or renew these approvals or licenses in a timely manner, or at all. In the event of any unanticipated delay in receipt of such approvals, the proposed capacity expansion plan may extend and any such delay could have an adverse impact on our growth, prospects, cash flows and financial condition.

The approvals required by our Company are subject to numerous conditions and there can be no assurance that these would not be suspended or revoked in the event of non-compliance or alleged non-compliance with any terms or conditions thereof, or pursuant to any regulatory action. If there is any failure by us to comply with the applicable regulations or if the regulations governing our business are amended, we may incur increased costs, be subject to penalties, have our approvals and permits revoked or suffer a disruption in our operations, any of which could adversely affect our business.

25. Our growth is closely tied to the outlook of industries that utilize copper in the production of their end products.

Our Company is mainly engaged in manufacturing of copper rods, copper wires (i.e. copper earthing wires, copper conductors & copper submersible wires) and copper strips. The copper products which we manufacture or deal in finds application mainly in power generation, transmission, distribution and electronic industries. Thus, our business is dependent on the performance and market trends of the power generation and transmission industries in India which may be affected by various factors outside our control, including prevailing general economic and market conditions, changes in the applicable governmental regulations, demographic trends, employment and income levels and interest rates, among other factors. In the event of any downturn or cyclical fluctuation in the power & electrical sector affecting the demand of copper products which we deal in or any developments that make our products less economically beneficial, could have an adverse impact on our business, financial condition and results of operations.

26. We are subject to competition from both organized and unorganized players in the market, which may significantly affect the fixation and realisation of the price for our product, which may adversely affect our business operation and financial condition.

The market for our products is competitive on account of existence of both the organized and unorganized players. Competition occurs generally on the key attributes such as quality of products, sales network, pricing and timely delivery. Some of our competitors have longer industry experience and greater financial, technical and other resources, which may enable them to adopt faster in changing market scenario and remain competitive. Moreover, the unorganized sector can offer their products at highly competitive prices which

may not be matched by us and consequently affect our volume of sales and growth prospects. Growing competition may result in a decline in our market share and may affect our margins which may adversely affect our business operations and our financial condition. Some of our significant competitors in the organized segment includes Rajnandini Metal Limited and Bhagyanagar India Limited.

We operate in a rapidly consolidating industry. The strength of combined companies could affect our competitive position in all of our business areas. Furthermore, if one of our competitors or their customers acquires any of our customers or suppliers, we may lose business from the customer or lose a supplier, which may adversely affect our business, results of operations and financial condition.

27. Our Company is in use of trademark  , which is not registered under the Trademarks Act, 1999 as on date of Prospectus. Thus, we may be subject to claims alleging breach of third party intellectual property rights.

As on date of Prospectus, we have made an application for registration of our logo  under the Trade Marks Act, 1999, however the same is pending for registration, hence, we do not enjoy the statutory protections accorded to a registered logo. We cannot assure you that the registration of our logo will be granted by the relevant authorities in a timely manner or at all. Further, there can be no assurance that third parties will not infringe our intellectual property, causing damage to our business prospects, reputation and goodwill. We may not be able to detect any unauthorized use or our efforts to protect our intellectual property may not be adequate and may lead to erosion of our business value and our operations could be adversely affected. We may need to litigate in order to determine the validity of such claims and the scope of the proprietary rights of others. Any such litigation could be time consuming and costly and the outcome cannot be guaranteed. For further details on our trademark, please refer to chapter titled “*Our Business*” beginning on page 98 of this Prospectus.

28. Compliance with and changes in safety, health and environmental laws and regulations may adversely affect our business, prospects, financial condition and results of operations.

Due to the nature of our business, we expect to be or continue to be subject to extensive and increasingly stringent environmental, health and safety laws and regulations and various labour, workplace and related law and regulations. We are also subject to environmental laws and regulations, including but not limited to:

- Environment (Protection) Act, 1986
- Air (Prevention and Control of Pollution) Act, 1981
- Water (Prevention and Control of Pollution) Act, 1974
- Hazardous Waste Management & Handling Rules, 2008
- The Indian Boilers Act, 1923
- Other regulations promulgated by the Ministry of Environment and Forests and the Pollution Control Boards of the state of Gujarat

which govern the discharge, emission, storage, handling and disposal of a variety of substances that may be used in or result from the operations of our business. The scope and extent of new environmental regulations, including their effect on our operations, cannot be predicted and hence the costs and management time required to comply with these requirements could be significant. Amendments to such statutes may impose additional provisions to be followed by our Company and accordingly the Company needs to incur clean-up and remediation costs, as well as damages, payment of fines or other penalties, closure of production facilities for non-compliance, other liabilities and related litigation, could adversely affect our business, prospects, financial condition and results of operations

29. We are heavily dependent on our Promoter and Key Managerial Personnel for the continued success of our business through their continuing services and strategic guidance and support.

Our success heavily depends upon the continued services of our Promoter and Key managerial personnel, particularly Prahladrai Ramdayal Heda, Nitin Kumar Heda & Mainsh Kumar Heda. We depend significantly on them for executing our day-to-day activities. The loss of any of our Promoter or Key Management Personnel, or failure to recruit suitable or comparable replacements, could have an adverse effect on us. The loss of service of the Promoters and other senior management could seriously impair the ability to continue to manage and expand the business efficiently. If we are unable to retain qualified employees at a reasonable cost, we may be unable to execute our growth strategy. For further details of our Directors and key managerial personnel, please refer to Section “*Our Management*” on page 125 of this Prospectus.

30. Our Company has unsecured loans which are repayable on demand. Any demand from lenders for repayment of such unsecured loans may adversely affect our cash flows.

Our Company has availed unsecured loans which may be recalled by lenders at any time with or without the existence of an event of default, on short or no notice. As of March 31, 2024, such loans amounted to Rs. 387.80 lakhs. In the event that any lender seeks a repayment of any such loan, our Company would need to find alternative sources of financing, which may not be available on

commercially reasonable terms, or at all. As a result, any such demand may materially affect our business, cash flows, financial condition and results of operations. For further details, please see the section entitled “**Statement of Financial Indebtedness**” on page 182 of this Prospectus.

31. Excessive dependence on HDFC Bank Limited in respect of loan facilities obtained by our Company.

Our company has been sanctioned credit facilities by HDFC Bank Limited and the Company is dependent on such facility for meeting its working capital requirements and other funding requirements. Any default under such arrangement with such lender may create problem for operation of the Company, which may affect the financial stability of the Company. At the same time this may result into difficulty in arranging for funds for re-payment and may also adversely affect the financial position of the Company. For further details regarding loans availed by our Company, please refer “**Statement of Financial Indebtedness**” on page 182 of this Prospectus.

32. We have in the past entered into related party transactions and may continue to do so in the future.

In the ordinary course of business, we have entered into transactions with certain related parties in the past and may continue to do so in future. We have entered into various transactions with our Directors/ Promoters, Promoter Group members and group companies. These transactions, inter alia include, remuneration, loans and advances, etc. For details, please refer to “**Annexure-J- Related Party Transactions**” under Section titled “**Financial Information of the Company**” on page 176 of this Prospectus. Our Company has entered such transactions due to easy proximity and quick execution on arms-length price in compliance with provisions of Companies Act 2013 and other applicable laws. Although all related-party transactions that we may enter into in the future are subject to approval by Board or shareholders, as required under the Companies Act, we cannot assure you that such future transactions or any other future transactions, individually or in aggregate, will not have an adverse effect on our financial condition and results of operations or that we could not have achieved more favourable terms if such transactions are not entered into with related parties.

Furthermore, it is likely that we may enter into related party transactions in the future. Any future transactions with our related parties could potentially involve conflicts of interest. Accordingly, there can be no assurance that such transactions, individually or in the aggregate, will not have a material adverse effect on our business, financial condition, cash flows, results of operations and prospects.

33. If we are not able to successfully manage our growth, our business and results of operations may be adversely affected.

Continued growth of our business and customer base requires us to expand our product portfolio, strengthen our product quality, expand and enhance our sales channels, better manage our supply chain, upgrade our information systems and technologies and devote other resources to our business expansions, among others. As we continue to grow, managing our business will become more complicated as we develop a wider product mix, some of which we may have less experience in. In addition, as we increase our product offerings, we will need to work with a larger number of business partners and maintain and expand mutually beneficial relationships with our existing and new business partners. Our inability to manage the expansion of our products range, customer base and manufacturing capacities, and execute our growth strategy in a timely manner or within budget estimates, or our inability to meet the expectations to track the changing preferences of our customers or other stakeholders could have an adverse effect on our business, results of operations and financial condition.

We cannot assure you that we will be able to effectively manage our growth, that our current personnel, infrastructure, systems, procedures and controls or any measures to enhance them will be adequate and successful to support our expanding operations or that our strategies and new business initiatives will be executed successfully. Our failure to manage our anticipated growth effectively could reduce our ability to execute our business strategies, recruit and retain personnel, innovate, and manage costs all of which could adversely affect our business, results of operations, cash flows and financial condition. In addition, the availability of funds plays a crucial role for growth and expansion of the business. Our ability to arrange financing and the costs of capital of such financing are dependent on numerous factors, including general economic and capital market conditions, credit availability from banks, investor confidence, the continued success of our operations and other laws that are conducive to our raising capital in this manner. Any downgrade in our credit ratings could increase our borrowing costs and adversely affect our access to capital. Further, in case we decide to raise additional funds through the issuance of equity or equity linked instruments, the interests of our shareholders may be diluted. Further, if we decide to meet our capital requirements through debt financing, our interest obligations shall increase and we may be subject to additional restrictive covenants under our respective financing arrangements. If we are unable to raise adequate capital in a timely manner and on acceptable terms, or at all, our business, results of operations and financial condition could be adversely affected.

34. Changes in technology may render our current technologies obsolete or require us to make substantial investments.

Modernization and technology up gradation is essential to reduce costs and increase the output. Our technology and machineries may become obsolete or may not be upgraded timely, hampering our operations and financial conditions and we may lose our competitive edge. Although we believe that we have installed updated technology, we shall continue to strive to keep our technology, plant and machinery in line with the latest technological standards. In case of a new found technology in the copper components or other products,

we may be required to implement new technology or upgrade the machineries and other equipment 's employed by us. Further, the costs in upgrading our technology and modernizing the plant and machineries are significant which could substantially affect our finances and operations.

35. Adverse publicity regarding our products could negatively impact us.

Adverse publicity regarding any of our products or similar products marketed or sold by others could negatively affect us. If any studies raise or substantiate concerns regarding the efficacy or safety of our products or other concerns, our reputation could be harmed and demand for our products could diminish, which could have a material adverse effect on growth in new customers and sales of our product, leading to a decline in revenues, cash collections, and ultimately our ability to meet operating cash flow requirements.

36. The average cost of acquisition of Equity Shares by our Promoters, is lower than the face value of Equity Share.

The average cost of acquisition of Equity Shares of our Promoters are lower than the face value of Equity Shares i.e. ₹ 10/-. For further details regarding the average cost of acquisition of Equity Shares by our Promoters in our Company and build-up of Equity Shares of our Promoters in our Company, please see Chapter titled "**Capital Structure**" beginning on page 59 of this Prospectus.

37. We have issued Equity Shares in the last 12 months at a price which could be lower than the Issue Price.

Our Company has during the preceding one year from the date of this Prospectus has made below mentioned allotments which were at a price lower than the Issue Price.

- Bonus issue of 35,00,000 shares of face value of Rs. 10/- each was made on January 18, 2024 in the ratio of 7:1 i.e., 7 (Seven) Equity shares of face value of Rs. 10/- each for every 1 (One) Equity shares of face value of Rs. 10/- each.
- Right Issue of 40,00,000 shares of face value of Rs. 10/- each at Premium of Rs 1.79/- each vide Board Meeting dated February 06, 2024.

For details, please refer to section titled "**Capital Structure**" on page 59 of this Prospectus.

38. Dependence upon transportation services for supply and transportation of our products are subject to various uncertainties and risks, and delays in delivery may result in rejection of products by customer.

We do not have an in-house transportation facility and we rely on third party transportation and other logistic facilities at every stage of our business activity including for procurement of products from our suppliers and for transportation of our finished products to our customers. For this purpose, we hire services of transportation companies. However, we have not entered into any definitive agreements with any third-party transport service providers and engage them on a need basis. Additionally, availability of transportation solutions in the markets we operate in is typically fragmented. The cost of our goods carried by such third-party transporters is typically much higher than the consideration paid for transportation, due to which it may be difficult for us to recover compensation for damaged, delayed or lost goods.

39. The Promoters (including Promoter Group) and Directors hold almost 100% of the Equity Shares of our Company and are therefore interested in the Company's performance in addition to their remuneration and reimbursement of expenses.

Our Promoter and Directors are interested in our Company, in addition to regular remuneration or benefits and reimbursement of expenses, to the extent of their shareholding in our Company or their relatives, dividend entitlement, or loans advanced by them to the Company, and benefits deriving from the directorship in our Company. There can be no assurance that our Promoter will exercise their rights as shareholders to the benefit and best interest of our Company. Our Promoters will continue to exercise significant control over us, including being able to control the composition of our Board of Directors and determine decisions requiring simple or special majority voting of shareholders, and our other shareholders may be unable to affect the outcome of such voting. For further information, please refer to the chapters/section titled "**Our Business**", "**Our Promoter and Promoter Group**" and "**Annexure J - Related Party Transactions**", beginning on pages 98, 138 and 176 respectively of this Prospectus.

40. We have incurred significant indebtedness which exposes us to various risks which may have an adverse-affect on our business and results of operations

Our ability to borrow and the terms of our borrowings will depend on our financial condition, the stability of our cash flows, general market conditions, economic and political conditions in the markets where we operate and our capacity to service debt. As on March 31, 2024, our total outstanding indebtedness was Rs. 3,491.74 lakhs.

Our significant indebtedness in future may result in substantial amount of debt service obligations which could lead to:

1. increasing our vulnerability to general adverse economic, industry and competitive conditions;
2. limiting our flexibility in planning for, or reacting to, changes in our business and the industry;
3. affecting our credit rating;
4. limiting our ability to borrow more money both now and in the future; and
5. increasing our interest expenditure and adversely affecting our profitability.

If the loans are recalled on a short notice, we may be required to arrange for funds to fulfil the necessary requirements. The occurrence of these events may have an adverse effect on our cash flow and financial conditions of the company. For further details regarding our indebtedness, see **“Statement of Financial Indebtedness”** on page 182 of this Prospectus.

41. The Issue Price of our Equity Shares may not be indicative of the market price of our Equity Shares after the Issue and the market price of our Equity Shares may decline below the Issue Price and you may not be able to sell your Equity Shares at or above the Issue Price.

The Issue price is based on numerous factors. For further information, see the chapter titled **“Basis for Issue Price”** beginning on page 77 of this Prospectus and may not be indicative of the market price of our Equity Shares after the Issue. The market price of our Equity Shares could be subject to significant fluctuations after the Issue and may decline below the Issue Price. We cannot assure you that you will be able to sell your Equity Shares at or above the Issue Price. The factors that could affect our share price are:

- Variations in the rate of growth of our financial indicators, such as earnings per share, net income and revenues;
- Changes in revenue or earnings;
- Domestic and international economic, legal and regulatory factors unrelated to our performance.

42. Loans availed by Our Company has been secured on personal guarantees of our Director. Our business, financial condition, results of operations, cash flows and prospects may be adversely affected in case of invocation of any personal guarantees provided by our Directors.

Our Promoters & Directors, i.e. Prahladrai Ramdayal Heda and Khushboo Manishkumar Heda provided corporate/personal guarantee to secure a significant portion of our existing borrowings taken from the banks and may continue to provide such guarantees and other security post listing. In case of a default under our loan agreements, any of the personal/corporate guarantees provided by the aforesaid may be invoked which could negatively impact their reputation and net worth. Also, we may face certain impediments in taking decisions in relation to our Company, which in turn would result in a material adverse effect on our financial condition, business, results of operations and prospects and would negatively impact our reputation. We may also not be successful in procuring alternate guarantees/alternate security satisfactory to the lenders, as a result may need to repay outstanding amounts under such facilities or seek additional sources of capital, which could affect our financial condition and cash flows. For further details regarding loans availed by our Company, please refer **“Statement of Financial Indebtedness”** on page 182 of this Prospectus.

43. Fraud, theft, employee negligence or similar incidents may adversely affect our results of operations and financial condition.

Our operations may be subject to incidents of theft or damage to inventory. The business may also encounter some inventory loss on account of employee theft, vendor fraud and general administrative error. While we have not experienced any such instance in the past, there can be no assurance that we will not experience any fraud, theft, employee negligence, security lapse or similar incidents in the future, which could adversely affect our results of operations and financial condition. Though we have insurance losses due to theft, fire, breakage or damage caused by other casualties, could adversely affect our results of operations and financial condition.

44. We could be harmed by employee misconduct or errors that are difficult to detect and any such incidences could adversely affect our financial condition, results of operations and reputation.

Employee misconduct or errors could expose us to business risks or losses, including regulatory sanctions and serious harm to our reputation. There can be no assurance that we will be able to detect or deter such misconduct. Moreover, the precautions we take to prevent and detect such activity may not be effective in all cases. Our employees may also commit errors that could subject us to claims and proceedings for alleged negligence, as well as regulatory actions on account of which our business, financial condition, results of operations and goodwill could be adversely affected.

45. We have not identified any alternate source of funding and hence any failure or delay on our part to mobilize the required resources or any shortfall in the Issue proceeds may delay the implementation schedule.

The proposed fund requirement for repayment of cash credit facility, as detailed in the section titled **“Objects of the Issue”** is to be funded from the proceeds of this Issue. We have not identified any alternate source of funding and hence any failure or delay on our part to mobilize the required resources or any shortfall in the Issue proceeds may delay the implementation schedule. We therefore, cannot

assure that we would be able to execute our future plans/strategy within the given timeframe. For details, please refer to the Chapter titled “*Objects of the Issue*” beginning on page 70 of this Prospectus.

46. *We may not be able to sustain effective implementation of our business and growth strategy.*

The success of our business will largely depend on our ability to effectively implement our business and growth strategy. In the past we have generally been successful in execution of our business but there can be no assurance that we will be able to execute our strategy on time and within the estimated budget in the future. If we are unable to implement our business and growth strategy, this may have an adverse effect on our business, financial condition and results of operations.

47. *We are subject to the restrictive covenants of banks in respect of the Loans/ Credit Limits and other banking facilities availed from them.*

Our financing arrangements contain restrictive covenants whereby we are required to obtain approval from our lender, regarding, among other things such as major changes in share capital, management, changes in fixed assets, creation of any other charge, undertake any guarantee obligation etc. There can be no assurance that such consents will be granted or that we will be able to comply with the financial covenants under our financing arrangements. In the event we breach any financial or other covenants contained in any of our financing arrangements, we may be required under the terms of such financing arrangements to immediately repay our borrowings either in whole or in part, together with any related costs. This may adversely impact our results of operations and cash flows. For further details on the Cash Credit Limits and other banking facilities, please see “*Statement of Financial Indebtedness*” on page 182 of the Prospectus.

48. *Any Penalty or demand raised by statutory authorities in future will affect our financial position of the Company.*

We specialize in the manufacture and supply of copper items which attracts tax liability such as Goods and Service tax and Income tax as per the applicable provisions of Law. We are also subject to the labour laws like depositing of contributions with Provident Fund. Any demand or penalty raised by the concerned authority in future for any previous years or current year will affect the financial position of the Company.

49. *The Objects of the Issue for which funds are being raised, are based on our management estimates and have not been appraised by any bank or financial institution or any independent agency.*

The deployment of funds will be entirely at our discretion, based on the parameters as mentioned in the chapter titled “*Objects of the Issue*”. The fund requirement and deployment, as mentioned in the “*Objects of the Issue*” on page 70 of this Prospectus is based on the estimates of our management and has not been appraised by any bank or financial institution or any other independent agency. These fund requirements are based on our current business plan. We cannot assure that the current business plan will be implemented in its entirety or at all. In view of the highly competitive and dynamic nature of our business, we may have to revise our business plan from time to time and consequently these fund requirements. The deployment of the funds as stated under chapter “*Objects of the Issue*” is at the discretion of our Board of Directors and is not subject to monitoring by any external independent agency. Further, we cannot assure that the actual costs or schedule of implementation as stated under chapter “*Objects of the Issue*” will not vary from the estimated costs or schedule of implementation. Any such variance may be on account of one or more factors, some of which may be beyond our control. Occurrence of any such event may delay our business plans and/or may have an adverse bearing on our expected revenues and earnings.

50. *Information relating to our production capacities and the historical capacity utilization of our production facilities included in this Prospectus is based on certain assumptions and has been subjected to rounding off, and future production and capacity utilization may vary.*

Information relating to our production capacities and the historical capacity utilization of our production facilities included in this Prospectus is based on various assumptions and estimates of our management, including proposed operations, assumptions relating to availability and quality of raw materials and assumptions relating to operational efficiencies. Actual production levels and utilization rates may differ significantly from the estimated production capacities or historical estimated capacity utilization information of our facilities. Undue reliance should therefore not be placed on our production capacity or historical estimated capacity utilization information for our existing facilities included in this Prospectus. For further information, see the section titled “*Our Business*” on page 98 of this Prospectus.

51. *Our ability to pay any dividends will depend upon future earnings, financial condition, cash flows, working capital requirements and capital expenditures.*

We may retain all our future earnings, if any, for use in the operations and expansion of our business. As a result, we may not declare dividends in the foreseeable future. Any future determination as to the declaration and payment of dividends will be at the discretion of

our Board of Directors and will depend on factors that our Board of Directors deem relevant, including among others, our results of operations, financial condition, cash requirements, business prospects and any other financing arrangements. Accordingly, realization of a gain on shareholder's investments may largely depend upon the appreciation of the price of our Equity Shares. There can be no assurance that our Equity Shares will appreciate in value. For details of our Dividend history refer to the Section "Dividend Policy" on page 143 of the Prospectus.

52. *The Equity Shares have never been publicly traded, and, after the Issue, the Equity Shares may experience price and volume fluctuations, and an active trading market for the Equity Shares may not develop. Further, the price of the Equity Shares may be volatile, and you may be unable to resell the Equity Shares at or above the Issue Price, or at all.*

Prior to the Issue, there has been no public market for the Equity Shares, and an active trading market on the Stock Exchanges may not develop or be sustained after the Issue. Listing and quotation do not guarantee that a market for the Equity Shares will develop, or if developed, the liquidity of such market for the Equity Shares. The Issue Price of the Equity Shares is proposed to be determined in accordance with the SEBI ICDR Regulations and may not be indicative of the market price of the Equity Shares at the time of commencement of trading of the Equity Shares or at any time thereafter. The market price of the Equity Shares may be subject to significant fluctuations in response to, among other factors, variations in our operating results of our Company, market conditions specific to the industry we operate in, developments relating to India, volatility in securities markets in jurisdictions other than India, variations in the growth rate of financial indicators, variations in revenue or earnings estimates by research publications, and changes in economic, legal and other regulatory factors.

53. *We may be subject to surveillance measures, such as the Additional Surveillance Measures (ASM) and the Graded Surveillance Measures (GSM) by the Stock Exchanges which may adversely affect trading price of our Equity Shares.*

SEBI and Stock Exchanges in order to enhance market integrity and safeguard interest of investors, have been introducing various enhanced pre-emptive surveillance measures. The main objective of these measures is to alert and advice investors to be extra cautious while dealing in these securities and advice market participants to carry out necessary due diligence while dealing in these securities. Accordingly, SEBI and Stock Exchanges have provided for (a) GSM on securities where such trading price of such securities does not commensurate with financial health and fundamentals such as earnings, book value, fixed assets, net-worth, price per equity multiple and market capitalization; and (b) ASM on securities with surveillance concerns based on objective parameters such as price and volume variation and volatility.

On listing, we may be subject to general market conditions which may include significant price and volume fluctuations. The price of our Equity Shares may also fluctuate after the Offer due to several factors such as volatility in the Indian and global securities market, our profitability and performance, performance of our competitors, changes in the estimates of our performance or any other political or economic factor. The occurrence of any of the abovementioned factors may trigger the parameters identified by SEBI and the Stock Exchanges for placing securities under the GSM or ASM framework such as net worth and net fixed assets of securities, high low variation in securities, client concentration and close to close price variation.

In the event our Equity Shares are subject to such pre-emptive surveillance measures implemented by any of the Stock Exchanges, we may be subject to certain additional restrictions in connection with trading of our Equity Shares such as limiting trading frequency (for example, trading either allowed once in a week or a month) or freezing of price on upper side of trading which may have an adverse effect on the market price of our Equity Shares or may in general cause disruptions in the development of an active trading market for our Equity Shares.

54. *Certain key performance indicators for certain listed industry peers included in this Prospectus have been sourced from public sources and there is no assurance that such financial and other industry information is complete*

Pursuant to the requirements of the SEBI ICDR Regulations, we have included certain key performance indicators, comprising financial and operational information, for certain listed industry peers, in the "Basis for Offer Price" beginning on page 77 of the Prospectus. Although this information is sourced from and relied upon on the consolidated audited financial statements of the relevant listed industry peers as available on the websites of the Stock Exchanges, including the annual reports of the respective companies submitted to Stock Exchanges, there is no assurance that this information with respect to industry peers is either complete. There maybe different methodologies and formulas used to compute the various ratios.

55. *There is no monitoring agency appointed by Our Company to monitor the utilization of the Issue proceeds.*

As per SEBI (ICDR) Regulations, 2018, as amended, appointment of monitoring agency is required only for Issue size above ₹10,000.00 Lakhs. Hence, we have not appointed any monitoring agency to monitor the utilization of Issue proceeds. However, the audit committee of our Board will monitor the utilization of Issue proceeds in terms of SEBI (Listing Obligations and Disclosure Requirements)

Regulations, 2015. Further, our Company shall inform about material deviations in the utilization of Issue proceeds to the stock exchange and shall also simultaneously make the material deviations / adverse comments of the audit committee public.

56. Our Promoter and the Promoter Group will jointly continue to retain majority shareholding in our Company after the issue, which will allow them to determine the outcome of the matters requiring the approval of shareholders.

Our promoter along with the promoter group will continue to hold majority of the Equity share capital of the company. As a result of the same, they will be able to exercise significant influence over the control of the outcome of the matter that requires approval of the majority shareholders vote. Such a concentration of the ownership may also have the affect of delaying, preventing or deterring any change in the control of our company. In addition to the above, our promoter will continue to have the ability to take actions that are not in, or may conflict with our interest or the interest of some or all of our minority shareholders, and there is no assurance that such action will not have any adverse effect on our future financials or results of operations.

57. Any future issuance of Equity Shares may dilute your shareholdings, and sale of the Equity Shares by our major shareholders may adversely affect the trading price of our Equity Shares.

Any future equity issuance by our Company may lead to the dilution of investors' shareholdings in our Company. In addition, any sale of substantial Equity Shares in the public market after the completion of this Offer, including by our major shareholders, or the perception that such sales could occur, could adversely affect the market price of the Equity Shares and could significantly impair our future ability to raise capital through offerings of the Equity Shares. We cannot predict what effect, if any, market sales of the Equity Shares held by the major shareholders of our Company or the availability of these Equity Shares for future sale will have on the market price of our Equity Shares.

58. We cannot guarantee the accuracy or completeness of facts and other statistics with respect to India, the Indian economy and industry in which we operate contained in the Prospectus.

While facts and other statistics in the Prospectus relating to India, the Indian economy and the industry in which we operate has been based on various governmental and organizational web site data that we believe are reliable, we cannot guarantee the quality or reliability of such materials. While we have taken reasonable care in the reproduction of such information, industry facts and other statistics have not been prepared or independently verified by us or any of our respective affiliates or advisors and, therefore we make no representation as to their accuracy or completeness. These facts and other statistics include the facts and statistics included in the chapter titled ***"Industry Overview"*** beginning on page 86 of this Prospectus. Due to possibly flawed or ineffective data collection methods or discrepancies between published information and market practice and other problems, the statistics herein may be inaccurate or may not be comparable to statistics produced elsewhere and should not be unduly relied upon. Further, there is no assurance that they are stated or compiled on the same basis or with the same degree of accuracy, as the case may be, elsewhere.

59. Certain data mentioned in this Prospectus has not been independently verified.

We have not independently verified data from industry publications contained herein and although we believe these sources to be reliable, we cannot assure that they are complete or reliable. Such data may also be produced on a different basis from comparable information compiled with regard to other countries. Therefore, discussions of matters relating to India and its economy are subject to the limitation that the statistical and other data upon which such discussions are based have not been verified by us and may be incomplete or unreliable.

60. There is no guarantee that the Equity Shares issued pursuant to the Issue will be listed on the SME Platform of National Stock Exchange of India Limited in a timely manner or at all.

In accordance with Indian law and practice, permission for listing and trading of the Equity Shares issued pursuant to the Issue will not be granted until after the Equity Shares have been issued and allotted. Approval for listing and trading will require all relevant documents authorizing the issuance of Equity Shares to be submitted. There could be a failure or delay in listing the Equity Shares on the SME Platform of National Stock Exchange of India Limited. Any failure or delay in obtaining the approval would restrict your ability to dispose of your Equity Shares.

61. QIBs and Non-Institutional Bidders are not permitted to withdraw or lower their Bids (in terms of quantity of Equity Shares or the Bid Amount) at any stage after submitting a Bid and Retail Individual Investors are not permitted to withdraw their Bids after Bid/Issue Closing Date.

Pursuant to the SEBI ICDR Regulations, QIBs and Non-Institutional Bidders are not permitted to withdraw or lower their Bids (in terms of quantity of Equity Shares or the Bid Amount) at any stage after submitting a Bid. Retail Individual Bidders can revise their Bids during the Bid/Issue Period and withdraw their Bids until Bid/Issue Closing Date. While we are required to complete Allotment, listing

and commencement of trading pursuant to the Issue within three (3) Working Days from the Bid/ Issue Closing Date, events affecting the Bidders' decision to invest in our Equity Shares, including adverse changes in international or national monetary policy, financial, political or economic conditions, our business, results of operations, cash flows and financial condition may arise between the date of submission of the Bid and Allotment, listing and commencement of trading. We may complete the Allotment, listing and commencement of trading of our Equity Shares even if such events occur and such events may limit the Bidders' ability to sell our Equity Shares Allotted pursuant to the Issue or may cause the trading price of our Equity Shares to decline on listing.

Retail Individual Investors can revise their Bids during the Bid/Issue Period and withdraw their Bids until Bid/Issue Closing Date. While our Company is required to complete all necessary formalities for listing and commencement of trading of the Equity Shares on all Stock Exchanges where such Equity Shares are proposed to be listed including Allotment pursuant to the Issue within three Working Days from the Bid/Issue Closing Date, events affecting the Bidders' decision to invest in the Equity Shares, including material adverse changes in international or national monetary policy, financial, political or economic conditions, our business, results of operations or financial condition may arise between the date of submission of the Bid and Allotment. Our Company may complete the Allotment of the Equity Shares even if such events occur, and such events limit the Bidders' ability to sell the Equity Shares Allotted pursuant to the Issue or cause the trading price of the Equity Shares to decline on listing.

EXTERNAL RISK FACTORS

62. A slowdown in economic growth in India may adversely affect our business, financial condition, cash flows, results of operations and prospects.

The performance and growth of our business are necessarily dependent on economic conditions prevalent in India, which may be materially and adversely affected by center or state political instability or regional conflicts, a general rise in interest rates, inflation, and economic slowdown elsewhere in the world or otherwise. Further, there have been periods of slowdown in the economic growth of India. India's economic growth is affected by various factors including domestic consumption and savings, balance of trade movements, namely export demand and movements in key imports (oil and oil products), global economic uncertainty and liquidity crisis, volatility in exchange currency rates and annual rainfall which affects agricultural production. Any continued or future slowdown in the Indian economy or a further increase in inflation could have a material adverse effect on the price of our raw materials and demand for our products and, as a result, on our business and financial results. The Indian financial market and the Indian economy are influenced by economic and market conditions in other countries, particularly in emerging market in Asian countries. Financial turmoil in Asia, Europe, the U.S. and elsewhere in the world in recent years has affected the Indian economy. Although economic conditions are different in each country, investors' reactions to developments in one country can have adverse effects on the securities of companies in other countries, including India. A loss in investor confidence in the financial systems of other emerging markets may cause increased volatility in Indian financial markets and, indirectly, in the Indian economy in general. Any worldwide financial instability, including the financial crisis and fluctuations in the stock markets in China and further deterioration of credit conditions in the U.S. or European markets, could also have a negative impact on the Indian economy. Financial disruptions may occur again and could harm our business and financial results.

63. Changing laws, rules and regulations and legal uncertainties in India, including adverse application of tax laws and regulations, may adversely affect our business and financial performance.

Our business and financial performance could be adversely affected by changes in law or interpretations of existing, or the promulgation of new, laws, rules and regulations in India applicable to us and our business. For further details please refer to the chapter "**Government and Other Approvals**" on page 199 for details of the laws currently applicable to us. There can be no assurance that the central or the state governments in India may not implement new regulations and policies which will require us to obtain approvals and licenses from the central or the state governments in India and other regulatory bodies or impose onerous requirements and conditions on our operations. Any such changes and the related uncertainties with respect to the implementation of the new regulations may have a material adverse effect on all our business, financial condition and results of operations. In addition, we may have to incur capital expenditures to comply with the requirements of any new regulations, which may also materially harm our results of operations. For instance, the Government has proposed a comprehensive national goods and services tax ("**GST**") regime that will combine taxes and levies by the Central and state Governments into a unified rate structure. Given the limited availability of information in the public domain concerning the GST, we are unable to provide any assurance as to the tax regime following implementation of the GST. The implementation of this new structure may be affected by any disagreement between certain state Governments, which could create uncertainty. Any such future amendments may affect our overall tax efficiency, and may result in significant additional taxes becoming payable.

64. Instability in financial markets could materially and adversely affect our results of operations and financial condition.

The Indian economy and financial markets are significantly influenced by worldwide economic, financial and market conditions. Any financial turmoil, especially in the United States of America or Europe, may have a negative impact on the Indian economy. Although economic conditions differ in each country, investors' reactions to any significant developments in one country can have adverse effects

on the financial and market conditions in other countries. A loss in investor confidence in the financial systems, particularly in other emerging markets, may cause increased volatility in Indian financial markets. The global financial turmoil, an outcome of the sub-prime mortgage crisis which originated in the United States of America, led to a loss of investor confidence in worldwide financial markets. Indian financial markets have also experienced the contagion affect of the global financial turmoil, evident from the sharp decline in SENSEX, BSE's benchmark index. Any prolonged financial crisis may have an adverse impact on the Indian economy and us, thereby resulting in a material and adverse affect on our business, operations, financial condition, profitability and price of our Equity Shares.

65. The occurrence of natural or man-made disasters could adversely affect our results of operations, cash flows and financial condition. Famine, War, Hostilities, terrorist attacks, civil unrest and other acts of violence could adversely affect the financial markets and our business.

The occurrence of natural disasters, including cyclones, storms, floods, earthquakes, famine, tsunamis, tornadoes, fires, explosions, pandemic disease and man-made disasters, including acts of terrorism and military actions, could adversely affect our results of operations, cash flows or financial condition. Our operations may be adversely affected by natural disasters and/or severe weather conditions, which can result in damage to our seeds inventory and hamper our productivity and may slow down our business operations temporarily or any other factor, which can adversely affect agriculture market in which we operate. In recent years, the extent and severity of these natural disasters determine their impact on the Indian economy. Prolonged spells of abnormal rainfall or other natural calamities could have a negative impact on the Indian economy, which could adversely affect our business, prospects, financial condition and results of operations as well as the price of the Equity Shares.

In addition, India has witnessed local civil disturbances in recent years, in particular communal violence across ethnic or communal lines involving conflicts, riots and other forms of violence between communities of different religious faith or ethnic origins, and it is possible that future civil unrest as well as other adverse social, economic or political events in India could have an adverse effect on our business. Terrorist attacks and other acts of violence or war may adversely affect the Indian securities markets. In addition, any deterioration in international relations, especially between India and its neighbouring countries, may result in investor concern regarding regional stability which could adversely affect the price of the Equity Shares. Such incidents could also create a greater perception that investment in Indian companies involves a higher degree of risk and could have an adverse effect on our business and the market price of the Equity Shares.

66. If certain labour laws become applicable to us, our profitability may be adversely affected.

India has stringent labour legislations that protect the interests of workers, including legislation that sets forth detailed procedures for dispute resolution and employee removal and legislation that imposes certain financial obligations on employers upon retrenchment. Any change or modification in the existing labour laws may affect our flexibility in formulating labour related policies.

67. Our performance is linked to the stability of policies and the political situation in India.

The Government of India has traditionally exercised, and continues to exercise, a significant influence over many aspects of the economy. Our business, and the market price and liquidity of our Equity Shares, may be affected by interest rates, changes in government policy, taxation, social and civil unrest and other political, economic or other developments in or affecting India. Any political instability in India may adversely affect the Indian securities markets in general, which could also adversely affect the trading price of our Equity Shares. Any political instability could delay the reform of the Indian economy and could have a material adverse affect on the market for our Equity Shares. There can be no assurance to the investors that these liberalization policies will continue under the newly elected government. Protests against privatization could slow down the pace of liberalization and deregulation. The rate of economic liberalization could change, and specific laws and policies affecting companies in the industrial equipment manufacturing sectors, foreign investment, currency exchange rates and other matters affecting investment in our securities could change as well. A significant change in India's economic liberalization and deregulation policies could disrupt business and economic conditions in India and thereby affect our business.

68. The extent and reliability of Indian infrastructure could adversely affect our Company's results of operations and financial condition.

India's physical infrastructure is in developing phase compared to that of many developed nations. Any congestion or disruption in its port, rail and road networks, electricity grid, communication systems or any other public facility could disrupt our Company's normal business activity. Any deterioration of India's physical infrastructure would harm the national economy, disrupt the transportation of goods and supplies, and add costs to doing business in India. These problems could interrupt our Company's business operations, which could have an adverse effect on its results of operations and financial condition.

69. Changing regulations in India could lead to new compliance requirements that are uncertain.

The regulatory environment in which we operate is evolving and is subject to change. The Government of India may implement new laws or other regulations that could affect the logistics industry or the sectors we serve, which could lead to new compliance requirements. New compliance requirements could increase our costs or otherwise adversely affect our business, financial condition and results of operations. Further, the manner in which new requirements will be enforced or interpreted can lead to uncertainty in our operations and could adversely affect our operations. Our business and financial performance could be adversely affected by any unexpected or onerous requirements or regulations resulting from any changes in laws or interpretation of existing laws, or the promulgation of new laws, rules and regulations. Any such changes and the related uncertainties with respect to the implementation or change in the legal framework may have a material adverse effect on our business, financial condition and results of operations.

70. Investor may be subject to Indian taxes arising out of capital gains on the sale of the Equity Shares.

Under current Indian tax laws, capital gains arising from the sale of equity shares within 12 months in an Indian company are classified as short-term capital gains and generally taxable. Any gain realized on the sale of listed equity shares on a stock exchange that are held for more than 12 months is considered as long-term capital gains and is taxable at 10%, in excess of Rs. 1,00,000. Any long-term gain realized on the sale of equity shares, which are sold other than on a recognized stock exchange and on which no STT has been paid, is also subject to tax in India. Capital gains arising from the sale of equity shares are exempt from taxation in India where an exemption from taxation in India is provided under a treaty between India and the country of which the seller is resident. Generally, Indian tax treaties do not limit India's ability to impose tax on capital gains. As a result, residents of other countries may be liable to pay tax in India as well as in their own jurisdiction on a gain on the sale of equity shares.

SECTION IV – INTRODUCTION**THE ISSUE**

PRESENT ISSUE IN TERMS OF THIS PROSPECTUS	
Equity Shares Offered through Public Issue⁽¹⁾⁽²⁾	Issue of 28,80,000 Equity Shares of ₹10 each for cash at a price of ₹105 (including a Share premium of ₹95 per Equity Share) per share aggregating to ₹3024.00 Lakhs.
Out of which:	
Issue Reserved for the Market Makers	1,48,800 Equity Shares of ₹10 each for cash at a price of ₹105 (including a Share premium of ₹95 per Equity Share) per share aggregating to ₹ 156.24 Lakhs
Net Issue to the Public	27,31,200 Equity Shares of ₹10 each for cash at a price of ₹105 (including a Share premium of ₹95 per Equity Share) per share aggregating to ₹2867.76 Lakhs
Out of which*	
A. QIB Portion ⁽³⁾⁽⁴⁾	Not more than 13,64,400 Equity Shares of ₹10 each for cash at a price of ₹105 (including a Share premium of ₹95 per Equity Share) per share aggregating to ₹1432.62 Lakhs
Of which	
i) Anchor Investor Portion	Upto 8,18,400 Equity Shares of ₹10 each for cash at a price of ₹105 (including a Share premium of ₹95 per Equity Share) per share aggregating to ₹859.32 Lakhs
ii) Net QIB Portion (assuming Anchor Investor Portion is fully subscribed)	Upto 5,46,000 Equity Shares of ₹10 each for cash at a price of ₹105 (including a Share premium of ₹95 per Equity Share) per share aggregating to ₹573.30 Lakhs
Of which	
B. Non-Institutional Portion	Not less than 4,10,400 Equity Shares of ₹10 each for cash at a price of ₹ 105 (including a Share premium of ₹95 per Equity Share) per share aggregating to ₹430.92 Lakhs
C. Retail Portion	Not less than 9,56,400 Equity Shares of ₹ 10 each for cash at a price of ₹105 (including a Share premium of ₹95 per Equity Share) per share aggregating to ₹1004.22 Lakhs
Pre and Post – Issue Equity Shares	
Equity Shares outstanding prior to the Issue	80,00,000 Equity Shares of face value of Rs.10 each.
Equity Shares outstanding after the Issue	1,08,80,000 Equity Shares of face value Rs.10 each.
Use of Net Proceeds by our Company	Please see the chapter titled “ <i>Objects of the Issue</i> ” on page 70 of this Prospectus.

Subject to finalisation of the Basis of Allotment, Number of shares may need to be adjusted for lot size upon determination of issue price.

Notes:

- 1) The Issue is being made in terms of Chapter IX of the SEBI (ICDR) Regulations, 2018, as amended from time to time. This Issue is being made by our company in terms of Regulation of 229(2) of SEBI (ICDR) Regulations read with Rule 19(2)(b)(i) of SCRR wherein not less than 25% of the post – issue paid up equity share capital of our company are being offered to the public for subscription.
- 2) The Issue has been authorized by the Board of Directors vide a resolution passed at its meeting held on May 01, 2024 and by the shareholder of our Company, vide a special resolution passed pursuant to Section 62(1)(c) of the Companies Act, 2013 at the extra ordinary general meeting held on May 06, 2024.
- 3) The SEBI (ICDR) Regulations permit the issue of securities to the public through the Book Building Process, which states that, not less than 15% of the Net Issue shall be available for allocation on a proportionate basis to Non-Institutional Bidders and not less than 35% of the Net Issue shall be available for allocation on a proportionate basis to Retail Individual Bidders and not more than 50% of the Net Issue shall be allotted on a proportionate basis to QIBs, subject to valid Bids being received at or above the Issue Price. Accordingly, we have allocated the Net Issue i.e. not more than 50% of the Net Issue to QIB and not less than 35% of the Net Issue shall be available for allocation to Retail Individual Investors and not less than 15% of the Net Issue shall be available for allocation to Non-institutional bidders.
- 4) Subject to valid Bids being received at or above the Issue Price, under subscription, if any, in any category, except in the QIB Portion, would be allowed to be met with spill-over from any other category or combination of categories of Bidders at the

discretion of our Company in consultation with the Book Running Lead Managers and the Designated Stock Exchange, subject to applicable laws.

- 5) Our Company may, in consultation with the Book Running Lead Manager, has allocated up to 60% of the QIB Portion to Anchor Investors on a discretionary basis in accordance with the SEBI (ICDR) Regulations. For further details, please refer section titled “**Issue Procedure**” beginning on page 227 of this Prospectus.

SUMMARY OF RESTATED FINANCIAL STATEMENTS**ANNEXURE – A: RESTATED STATEMENT OF ASSETS AND LIABILITIES****(Amount in Rs. Lakhs)**

Particulars		As at		
		March 31, 2024	March 31, 2023	March 31, 2022
A.	Equity and Liabilities			
1	Shareholders' Funds			
	Share Capital	800.00	50.00	1,158.58
	Reserves & Surplus	1,203.90	312.08	0.00
	Share application money pending allotment			
2	Non-Current Liabilities			
	Long-Term Borrowings	342.83	2,238.38	1,135.52
	Long-Term Provisions	4.71	3.71	2.28
	Deferred Tax Liabilities (Net)	55.81	63.33	72.42
3	Current Liabilities			
	Short Term Borrowings	3,148.91	2,408.44	1,396.86
	Trade Payables:			
	(A) total outstanding dues of micro enterprises and small enterprises; and	0.80	436.62	188.31
	(B) total outstanding dues of creditors other than micro enterprises and small enterprises."	49.75	1,167.37	658.79
	Other Current Liabilities	397.66	277.21	30.85
	Short Term Provisions	316.87	205.42	158.43
	Total	6,321.24	7,162.56	4,802.05
B.	Assets			
1	Non-Current Assets			
	Property, Plant and Equipment			
	Tangible Assets	1,386.07	1,387.82	1,334.64
	Intangible Assets	0.00	0.00	0.00
	Non-Current Investments	0.00	0.00	0.00
	Deferred Tax Assets	0.00	0.00	0.00
	Long Term Loans & Advances	0.00	0.00	0.30
	Other Non-Current Assets	25.82	84.17	48.44
2	Current Assets			
	Current Investments	0.00	0.00	0.00
	Inventories	2,969.56	3,875.67	2,404.54
	Trade Receivables	1,422.40	1,167.75	505.35
	Cash and Cash Equivalents	7.34	203.22	4.77
	Short-Term Loans and Advances	162.51	123.46	299.63
	Other Current Assets	347.54	320.47	204.39
	Total	6,321.24	7,162.56	4,802.05

ANNEXURE – B: RESTATED STATEMENT OF PROFIT AND LOSS

(Amount in Rs. Lakhs)

Particulars		For the year ended		
		March 31, 2024	March 31, 2023	March 31, 2022
A.	Revenue:			
	Revenue from Operations	1,16,627.09	1,15,018.88	93,719.32
	Other income	28.00	21.03	72.48
	Total revenue	1,16,655.09	1,15,039.91	93,791.80
B.	Expenses:			
	Cost of Material Consumed	1,10,513.26	1,10,097.69	90,290.65
	Purchase of Stock-in-Trade	1,934.21	1,553.49	693.04
	Change in Inventories of WIP, Finished Goods & Packing Material	-653.18	-370.86	-35.37
	Employees Benefit Expenses	249.81	229.44	156.05
	Finance costs	468.23	472.76	290.79
	Depreciation and Amortization	243.26	239.16	219.98
	Other expenses	2,719.49	2,062.74	1,612.13
	Total Expenses	1,15,475.08	1,14,284.42	93,227.27
	Profit before exceptional and extraordinary items and tax	1,180.01	755.49	564.53
	Exceptional Items	0.00	0.00	0.00
	Profit before extraordinary items and tax	1,180.01	755.49	564.53
	Extraordinary items	0.00	0.00	0.00
	Profit before tax	1,180.01	755.49	564.53
	Tax expense:			
	Current tax	297.18	204.31	148.12
	Deferred Tax	-7.53	-9.09	-9.62
	Profit (Loss) for the period from continuing operations	890.36	560.27	426.03
	Earning per equity share in Rs.:			
	(1) Basic	19.35	14.01	10.65
	(2) Diluted	19.35	14.01	10.65

ANNEXURE – C: RESTATED STATEMENT OF CASH FLOWS

(Amount in Rs. Lakhs)

Particulars	For the year ended		
	March 31, 2024	March 31, 2023	March 31, 2022
A. CASH FLOW FROM OPERATING ACTIVITIES			
Profit/ (Loss) before tax	1,180.01	755.49	564.53
Adjustments for:			
Depreciation	243.26	239.16	219.98
Finance Cost	468.23	472.76	290.79
Interest Income	-10.00	-3.16	-63.36
Operating profit before working capital changes	1,881.50	1,464.25	1,011.94
Movements in working capital :			
(Increase)/Decrease in Inventories	906.11	-1,471.13	-1,307.42
(Increase)/Decrease in Trade Receivables	-254.65	-662.40	173.31
(Increase)/Decrease in Short Term Loans & Advances	-39.05	176.17	-66.50
(Increase)/Decrease in Other Current Assets	-27.07	-116.08	-162.04
Increase/(Decrease) in Trade Payables	-1,553.44	756.89	-283.56
Increase/(Decrease) in Other Current Liabilities	120.45	246.36	-117.41
Increase/(Decrease) in Long Term Provisions	1.00	1.43	1.52
Increase/(Decrease) in Short Term Provisions	111.45	46.99	110.54
Cash generated from operations	1,146.31	442.47	-639.62
Adjustment on Account of Income Tax Expense	-17.31	-204.31	-148.12
Net cash from operating activities (A)	1,128.99	238.16	-787.74
B. CASH FLOW FROM INVESTING ACTIVITIES			
Sale/(Purchase) of Investments	0.00	0.00	0.00
(Increase)/Decrease in Long Term Loans & Advances	0.00	0.30	-0.30
Interest Income	10.00	3.16	63.36
Sale/(Purchase) of Fixed Assets	-241.51	-292.33	-308.22
(Increase)/Decrease in Other Non-Current Assets	58.35	-35.73	16.33
Net cash from investing activities (B)	-173.16	-324.60	-228.83
C. CASH FLOW FROM FINANCING ACTIVITIES			
Interest/Other expenses paid on borrowings	-468.23	-472.76	-290.79
Proceeds/(Repayment) of Long Term Borrowings	-1,895.55	1,102.86	-130.01
Increase/(Decrease) in Short Term Borrowings	740.47	1,011.58	951.00
Increase/(Decrease) in Capital	471.60	-1,356.79	110.37
Net cash from financing activities (C)	-1,151.71	284.89	640.57
Net increase in cash and cash equivalents (A+B+C)	-195.88	198.45	-376.00
Cash and cash equivalents at the beginning of the year	203.22	4.77	380.77
Cash and cash equivalents at the end of the year	7.34	203.22	4.77

GENERAL INFORMATION**Brief Summary:**

Our company was originally formed as partnership firm under the Indian Partnership Act, 1932 (“Partnership Act”) in the name and style of “M/s. Sunlite Industries, pursuant to a deed of partnership entered between Prahladrai Ramdayal Heda, Nitin Kumar Heda and Khushboo Manishkumar Heda executed on dated September 28, 2017 on the terms and conditions contained in the said partnership deed. Later on, “M/s Sunlite Industries” was thereafter converted from partnership firm to a private limited Company under part I Chapter XXI of Section 366 of the Companies Act, 2013 with the name and style of “Sunlite Alucop Private Limited” and received a certificate of incorporation dated August 04, 2022 issued by the Registrar of Companies, Central Registration Centre bearing Corporate Identification Number U27200GJ2022PTC134540. Further, pursuant to Special Resolution passed by the shareholders at the Extra Ordinary General Meeting held on January 12, 2024, the name of our Company was changed from “Sunlite Alucop Private Limited” to “Sunlite Recycling Industries Private Limited” and a fresh certificate of incorporation consequent upon change of name was issued by the Registrar of Companies, Ahmedabad vide letter dated January 18, 2024. Subsequently, our Company was converted into a Public Limited Company vide Special Resolution passed by the Shareholders at the Extra Ordinary General Meeting, held on February 10, 2024 and consequently the name of our Company was changed from “Sunlite Recycling Industries Private Limited” to “Sunlite Recycling Industries Limited” vide a fresh certificate of incorporation consequent upon conversion from private company to public company dated April 30, 2024 issued by the Registrar of Companies, Central Processing Centre. Our Company’s Corporate Identity Number is U27200GJ2022PLC134540.

For further details please refer to chapter titled “**History and Corporate Structure**” beginning on page 121 of this Prospectus.

Registered Office of our Company:**Sunlite Recycling Industries Limited**

Survey No. 270A & Plot No. 1, Survey No. 267,
Chhatha Mile, Dantali, Vaso, Kheda -387350, Gujarat, India.

Tel. No.: +91-9265111757

Email: info@sunliteindustries.com

Website: www.sunliteindustries.com

CIN: U27200GJ2022PLC134540

Registration No.: 134540

Address of the Registrar of Companies:**Registrar of companies, Ahmedabad**

RoC Bhavan, Opp Rupal Park Society, Behind Ankur Bus Stop,
Naranpura, Ahmedabad-380013, Gujarat, India.

Tel No: +91-79-27438531

Email id: roc.ahmedabad@mca.gov.in

Website: www.mca.gov.in

Board of Directors:

The following table sets out details regarding our Board as on the date of filing of this Prospectus consists of:

Sr. No.	Name of Directors	Designation	DIN	Address
1.	Nitin Kumar Heda	Managing Director	00383855	7 Mangal Murti Society, Petlad Road, Nadiad, Kheda 387002, Gujarat, India.
2.	Prahladrai Ramdayal Heda	Chairman & Whole Time Director	09696242	62 Prime Flora, Near Santram Deri, Nadiad, Kheda 387002, Gujarat, India.
3.	Khushboo Manishkumar Heda	Non-Executive Director	09696263	7 Mangal Murti Society, Petlad Road, Nadiad, Kheda 387002, Gujarat, India.
4.	Ronak Ashokbhai Mehta	Independent Director	10525257	D-503 ICB Flora, Behind Vodafone Tower, Gota, Daskroi, Ahmedabad 382481, Gujarat, India.
5.	Jaimish Govindbhai Patel	Independent Director	09647742	412-2306, Gujarat Housing Board Nr, Navarang Flat, Bapunagar, Ahmedabad City – 380024, Gujarat, India.

For further details in relation to our Directors, please refer to chapter titled “**Our Management**” on page 125 of this Prospectus.

Chief Financial Officer	Company Secretary & Compliance Officer
Manish Kumar Heda Sunlite Recycling Industries Limited Survey No. 270A & Plot No. 1 Survey No. 267, Chhatha Mile, Dantali, Vaso, Kheda -387350, Gujarat, India. Tel. No.: +91-9265111757 Email: info@sunliteindustries.com Website: www.sunliteindustries.com	Nikita Sharma Sunlite Recycling Industries Limited Survey No. 270A & Plot No. 1 Survey No. 267, Chhatha Mile, Dantali, Vaso, Kheda -387350, Gujarat, India. Tel. No.: +91-9265111757 Email: cs@sunliteindustries.com Website: www.sunliteindustries.com

Investor Grievances:

Investors may contact our Company Secretary and Compliance Officer and/or the Registrar to the Issue and/or the Book Running Lead Manager, in case of any pre-issue or post-issue related problems, such as non-receipt of letters of allotment, credit of allotted Equity Shares in the respective beneficiary account or refund orders, etc.

All grievances in relation to the application through ASBA process may be addressed to the Registrar to the Issue, with a copy to the relevant Designated Intermediary with whom the ASBA Form was submitted, giving details such as the full name of the sole or First Applicant, ASBA Form number, Applicants' DP ID, Client ID, PAN, number of Equity Shares applied for, date of submission of ASBA Form, address of Bidder, the name and address of the relevant Designated Intermediary, where the ASBA Form was submitted by the Bidder, ASBA Account number in which the amount equivalent to the Bid Amount was blocked and UPI ID used by the Retail Individual Investors. Further, the Bidder shall enclose the Acknowledgment Slip from the Designated Intermediaries in addition to the documents or information mentioned hereinabove.

For all Issue related queries and for redressal of complaints, Applicants may also write to the Book Running Lead Manager. All complaints, queries or comments received by Stock Exchange/ SEBI shall be forwarded to the Book Running Lead Manager, who shall respond to the same.

All grievances relating to the Anchor Investors may be addressed to the Registrar to the Issue, giving full details such as name of the sole or first Applicant, Bid cum Application Form number, Applicants DP ID, Client ID, PAN, date of the Anchor Investor Application Form, address of the Applicant, number of Equity Shares applied for, Bid Amount paid on submission of the Anchor Investor Application Form and the name and address of the relevant BRLM where the Anchor Investor Application Form was submitted by the Anchor Investor. For all Issue related queries and for redressal of complaints, investors may also write to the BRLM.

Details of Key Intermediaries pertaining to this Issue and our Company:

Book Running Lead Manager to the Issue	Legal Advisor to the Issue
Hem Securities Limited Address: 904, A Wing, Naman Midtown, Senapati Bapat Marg, Elphinstone Road, Lower Parel, Mumbai-400013, Maharashtra, India. Tel No.: +91-22-4906 0000 Email: ib@hemsecurities.com Investor Grievance Email: redressal@hemsecurities.com Website: www.hemsecurities.com Contact Person: Ajay Jain SEBI Reg. No.: INM000010981	Mindspright Legal Address: 712-714, C-Wing, Trade World, Kamla City, Senapati Bapat Marg, Lower Parel (West), Mumbai-400013, Maharashtra, India. Contact Person: Richa Bhansali Tel No.: +91-22- 42197000 Email: legal@mindspright.co.in Website: www.mindspright.co.in
Registrar to the Issue	Statutory Auditor
Cameo Corporate Services Limited Address: Subramanian Building No.1, Club House Road, Chennai-600002, Tamil Nadu, India. Tel No.: +91-44-40020700/28460390 Email: ipo@cameoindia.com Website: www.cameoindia.com Investor Grievance Email: investor@cameoindia.com Online Investor Portal : https://wisdom.cameoindia.com/	M/s. Abhishek Kumar & Associates Chartered Accountants, Address: 401, Silicon Tower, Above Freezeland Restaurant, Nr. Samarsheshwar Mahadev Temple, Law Garden, Navrangpura, Ahmedabad-380009, Gujarat, India. Tel No.: +91-9227404064 Email: abhisheksagrawal@yahoo.co.in Website: www.abhisheksagrawal.com

Contact Person: Ms. K Sreepriya Designation: Vice President & Company Secretary SEBI Registration Number: INR000003753 CIN: U67120TN1998PLC041613	Firm Registration No.: 130052W Peer Review Certificate Number: 014429 Membership No: 132305 Contact Person: CA Abhishekkumar Agarwal
Bankers to our Company	
HDFC Bank Limited Address: No.101 & 102, 1 st Floor, Iscon Complex, College Road, Nadiad -387001, Gujarat, India. Tel. No.: +91 9376412310 Contact Person: Gaurav Patel Designation: Branch Manager Email: gaurav.patel@hdfcbank.com Website: www.hdfcbank.com	Axis Bank Limited Address: 3, Shree Ambica Agency, College Road, Kheda, Opposite Mahagujarat Hospital, Nadiad 387001, Gujarat, India. Tel. No.: +91 9979852126 Contact Person: Sohil Vahora Designation: Asst.Vice President Email: nadiad.branchhead@axisbank.com Website: www.axisbank.com
Bankers to the Issue/ Refund Banker/Sponsor Bank	Syndicate Member
HDFC Bank Limited Address: FIG-OPS Department, Lodha - I Think Techno Campus, O-3 Level, Next to Kanjurmarg Railway Station, Kanjurmarg (East), Mumbai – 400042 Maharashtra, India. Tel: +91-22-30752929/28/14 Email: siddharth.jadhav@hdfcbank.com , eric.bacha@hdfcbank.com , sachin.gawade@hdfcbank.com , tushar.gavankar@hdfcbank.com , pravin.teli2@hdfcbank.com Contact Person: Eric Bacha/ Sachin Gawade/ Pravin Teli/ Siddharth Jadhav/ Tushar Gavankar Website: www.hdfcbank.com SEBI Registration Number: INBI00000063	Hem Finlease Private Limited Address: 203, Jaipur Tower, M. I. Road, Jaipur-302001, Rajasthan, India. Tel No.: +91-141-4051000 Email Id: ashoks@hemsecurities.com Website: www.hemsecurities.com Contact Person: Ashok Soni SEBI Registration Number: INZ000167734

Designated Intermediaries:**Self-Certified Syndicate Banks (SCSB's)**

The list of banks that have been notified by SEBI to act as SCSBs for the ASBA process is provided on the website of the SEBI (<https://www.sebi.gov.in/sebiweb/other/OtherAction.do?doRecognised=yes>) and updated from time to time. For details on Designated Branches of SCSBs collecting the Bid-cum-Application Forms, refer to the above-mentioned SEBI link.

Further, as notified by SEBI vide its circular no. SEBI/HO/CFD/DIL2/CIR/P/2019/85 dated July 26, 2019; the applications through UPI in IPOs can be made only through the SCSBs/ mobile applications whose name appears on the SEBI website www.sebi.gov.in in at the following path: Home >> Intermediaries/Market Infrastructure Institutions >> Recognized intermediaries >> Self Certified Syndicate Banks eligible as Issuer Banks for UPI.

Investor shall ensure that when applying in IPO using UPI, the name of his Bank appears in the list of SCSBs displayed on the SEBI website which are live on UPI. Further, he/she shall also ensure that the name of the app and the UPI handle being used for making the application is also appearing in the aforesaid list.

Syndicate SCSB Branches

In relation to ASBA Bids submitted to a member of the Syndicate, the list of branches of the SCSBs at the Specified Locations named by the respective SCSBs to receive deposits of Bid cum Application Forms from the members of the Syndicate is available on the website of the SEBI <http://www.sebi.gov.in/sebiweb/other/OtherAction.do?doRecognisedFpi=yes&intmId=35> and updated from time to time. For more information on such branches collecting Bid-cum-Application Forms from the Syndicate at Specified Locations, refer to the above-mentioned SEBI link.

Registered Brokers

Bidders can submit Bid cum Application Forms in the Issue using the stock brokers network of the Stock Exchanges, i.e., through the Registered Brokers at the Broker Centres. The list of the Registered Brokers eligible to accept ASBA forms, including details such as

postal address, telephone number and email address, is provided on the website of the SEBI at (<https://www.sebi.gov.in/sebiweb/other/OtherAction.do?doRecognised=yes>), respectively, as updated from time to time.

Registrar and Share Transfer Agents

The list of the Registrar to Issue and Share Transfer Agents (RTAs) eligible to accept Applications forms at the Designated RTA Locations, including details such as address, telephone number and e-mail address, are provided at <https://www.sebi.gov.in/sebiweb/other/OtherAction.do?doRecognisedFpi=yes&intmId=10> , as updated from time to time.

Collecting Depository Participants (CDP's)

The list of the Collecting Depository Participants (CDPs) eligible to accept Application Forms at the Designated CDP Locations, including details such as name and contact details, are provided at <https://www.sebi.gov.in/sebiweb/other/OtherAction.do?doRecognisedFpi=yes&intmId=19> for NSDL CDPs and at <https://www.sebi.gov.in/sebiweb/other/OtherAction.do?doRecognisedFpi=yes&intmId=18> for CDSL CDPs, as updated from time to time. The list of branches of the SCSBs named by the respective SCSBs to receive deposits of the Bid cum Application Forms from the Designated Intermediaries will be available on the website of the SEBI (www.sebi.gov.in) and updated from time to time.

Brokers to the Issue

All members of the recognized stock exchanges would be eligible to act as Brokers to the Issue.

Experts Opinion

Except for the reports in the section “*Statement of Special Tax Benefits*”, “*Financial Information of the Company*” “*Statement of Financial Indebtedness*” on page 83, 144 and 182 respectively of this Prospectus from the Statutory Auditor, our Company has not obtained any expert opinions. We have received written consent from the Statutory Auditor for inclusion of their name in this Prospectus, as required under Companies Act read with SEBI (ICDR) Regulations as “**Expert**”, defined in section 2(38) of the Companies Act and such consent has not been withdrawn as on the date of this Prospectus. However, the term “**expert**” shall not be construed to mean an “**expert**” as defined under the U.S. Securities Act, 1933.

Inter-se Allocation of Responsibilities

Since, Hem Securities Limited is the sole Book Running Lead Manager to this Issue, a statement of inter se allocation of responsibilities among Book Running Lead Manager is not applicable.

Monitoring Agency

As per SEBI (ICDR) Regulations, 2018, appointment of monitoring agency is required only if Issue size exceeds ₹10,000 Lakhs. Hence, our Company is not required to appoint a monitoring agency in relation to the issue. However, as per section 177 of the Companies Act, Audit Committee of our Company will be monitoring the utilization of the Issue Proceeds.

Green Shoe Option

No Green Shoe Option is applicable for this Issue.

Appraising Entity

None of the objects for which the Net Proceeds are proposed to be utilized have been financially appraised by any banks or financial institution.

Credit Rating

As this is an issue of Equity Shares, there is no credit rating for the Issue.

IPO Grading

Since the issue is being made in terms of Chapter IX of the SEBI (ICDR) Regulations, 2018 there is no requirement of appointing an IPO Grading agency.

Trustees

As the Issue is of Equity Shares, the appointment of trustees is not required.

Debenture Trustees

As this is an issue of Equity Shares, the appointment of Debenture trustees is not required.

Filing of Offer Document with the Designated Stock Exchange/SEBI/ROC

The Prospectus is being filed with SME Platform of National Stock Exchange of India Limited, Exchange Plaza, C-1, Block-G, Bandra Kurla Complex, Bandra (East), Mumbai 400051, Maharashtra, India.

The Draft Red Herring Prospectus will not be filed with SEBI, nor will SEBI issue any observation on the Offer Document in terms of Regulation 246(2) of SEBI (ICDR) Regulations, 2018. Pursuant to Regulation 246(5) of SEBI (ICDR) Regulations, 2018 and SEBI Circular Number SEBI/HO/CFD/DIL1/CIR/P/2018/011 dated January 19, 2018, a copy of Red Herring Prospectus/Prospectus will be filed online through SEBI Intermediary Portal at <https://siportal.sebi.gov.in>

A copy of the Red Herring Prospectus, along with the material contracts and documents required to be filed under Section 26 & 32 of the Companies Act, 2013 was filed to the Registrar of Companies and a copy of the Prospectus to be filed under Section 26 and 32 of the Companies Act, 2013 would be filed to the Registrar of Companies through the electronic portal at <http://www.mca.gov.in>.

Book Building Process

Book Building, in context to the Issue, refers to the process of collection of Bids from bidders on the basis of the Prospectus within the Price Band. The Price Band shall be determined by our Company in consultation with the Book Running Lead Manager in accordance with the Book Building Process, and advertised in in all editions of the English national newspaper Business Standard, all editions of Hindi national newspaper Business Standard and Gujarati edition of Regional newspaper Ahmedabad Express where our registered office is situated at least two working days prior to the Bid/ Issue Opening date. The Issue Price shall be determined by our Company, in consultation with the Book Running Lead Manager in accordance with the Book Building Process after the Bid/ Issue Closing Date.

All Bidders, are mandatorily required to use the ASBA process for participating in the Issue. In accordance with the SEBI (ICDR) Regulations, QIBs bidding in the QIB Portion and Non-Institutional Bidders bidding in the Non-Institutional Portion are not allowed to withdraw or lower the size of their Bids (in terms of the quantity of the Equity Shares or the Bid Amount) at any stage. Retail Individual Bidders can revise their Bids during the Bid/Issue Period and withdraw their Bids until the Bid/Issue Closing Date.

In terms of SEBI ICDR Regulations, QIBs and Non-Institutional Investors were not permitted to withdraw their Bid(s) or lower the size of their Bid(s) (in terms of number of Equity Shares or the Bid Amount) at any stage. RIIs Bidding could revise their Bid(s) during Bid/ Issue Period and withdraw their Bid(s) until Bid/ Issue Closing date. Allocation in the issue will be made on a proportionate basis.

In terms of SEBI Circular No. CIR/CFD/POLICYCELL/11/2015 dated November 10, 2015 and the SEBI (Issue of Capital and Disclosure Requirements) Regulations, 2018, all the investors (except Anchor Investors) applying in a public issue shall use only Application Supported by Blocked Amount (ASBA) process for application providing details of the bank account which will be blocked by the Self Certified Syndicate Banks (SCSBs) for the same. Further, pursuant to SEBI Circular No. SEBI/HO/CFD/DIL2/CIR/P/2018/138 dated November 01, 2018, Retail Individual Investors applying in public issue may use either Application Supported by Blocked Amount (ASBA) facility for making application or also can use UPI as a payment mechanism with Application Supported by Blocked Amount for making application. For details in this regards, specific attention are invited to the chapter titled "**Issue Procedure**" beginning on page 227 of the Prospectus.

The process of Book Building under the SEBI (ICDR) Regulations is subject to change from time to time and the investors are advised to make their own judgment about investment through this process prior to making a Bid or application in the Issue.

For further details on the method and procedure for Bidding, please see section entitled "**Issue Procedure**" on page 227 of this Prospectus.

Underwriting

The Company and the Book Running Lead Manager to the Issue hereby confirm that the Issue will be 100% Underwritten by the Underwriter Hem Securities Limited in the capacity of Underwriter to the issue.

Pursuant to the terms of the Underwriting Agreement dated June 25, 2024 entered into by Company, Underwriter, the obligations of the Underwriter are subject to certain conditions specified therein. The Details of the Underwriting commitments are as under:

Details of the Underwriter	No. of shares underwritten	Amount Underwritten (₹ in Lakhs)	% of Total Issue Size Underwritten
Hem Securities Limited Address: - 904, A Wing, Naman Midtown, Senapati Bapat Marg, Elphinstone Road, Lower Parel, Mumbai 400013, India Tel No.: +91-22-4906 0000 Email: ib@hemsecurities.com Investor Grievance Email: redressal@hemsecurities.com Website: www.hemsecurities.com Contact Person: Rohit Sharma SEBI Registration Number: INM000010981	28,80,000	3024.00	100%

*Includes 1,48,800 Equity Shares of the Market Maker Reservation Portion which are to be subscribed by the Market Maker, Hem Finlease Private Limited in its own account in order to claim compliance with the requirements of Regulation 261 of the SEBI (ICDR) Regulations, 2018, as amended.

In the opinion of the Board of Directors of our Company, the resources of the above mentioned Underwriter are sufficient to enable them to discharge their respective obligations in full.

Change in Auditors during the last three (3) years:

Except as stated below, there have been no changes in our Company's auditors in the last three (3) years.

Details of Auditors	Date of Change	Reason for Change
M/s. Gopal Shah & Co. Chartered Accountants, Address: A-916, Ratnakar Nine Square, Keshavbagh Party Plot, Mansi Circle, Ahmedabad-380015, Gujarat, India. Tel No.: +91 -79-40054044/9428116623 Email: gopalshahco@gmail.com Website: www.gopalshahco.com Firm Registration No.: 103301W Membership No: 137467 Contact Person: CA Jigar Shah	Date of appointment: September 15, 2022 Date of resignation: January 01, 2024	Due to pre-occupation in other assignments
M/s. Abhishek Kumar & Associates Chartered Accountants, Address: 401, Silicon Tower, Above Freezeland Restaurant, Nr. Samartheshwar Mahadev Temple, Law Garden, Navrangpura, Ahmedabad-380009, Gujarat, India. Tel No.: +91 -9227404064 Email: abhisheksagrawal@yahoo.co.in Website: www.abhisheksagrawal.com Firm Registration No.: 130052W Peer Review Certificate Number: 014429 Membership No: 132305 Contact Person: CA Abhishek Kumar Agarwal	Date of appointment: January 16, 2024	Auditor appointed in casual vacancy

Details of the Market Making arrangement for this Issue

Our Company has entered into a Market Making Agreement dated June 25, 2024 with the following Market Maker for fulfilling the Market Making obligations under this Issue:

Name	Hem Finlease Private Limited
Correspondence Address:	203, Jaipur Tower, M I Road, Jaipur, Rajasthan 302001, India
Tel No.:	+91 -141-4051000

E-mail:	ib@hemsecurities.com
Website:	www.hemsecurities.com
Contact Person:	Ashok Soni
SEBI Registration No.:	INZ000168034
Market Maker Registration No.	SMEREG2020090906741

In accordance with Regulation 261 of the SEBI (ICDR) Regulations, we have entered into an agreement with the Book Running Lead Manager and the Market Maker (duly registered with NSE to fulfill the obligations of Market Making) dated June 25, 2024 to ensure compulsory Market Making for a minimum period of three years from the date of listing of equity shares offered in this Issuer.

Hem Finlease Private Limited, registered with SME Platform of NSE “NSE Emerge” act as the Market Maker and has agreed to receive or deliver of the specified securities in the market making process for a period of three years from the date of listing of our Equity Shares or for a period as may be notified by any amendment to SEBI (ICDR) Regulations.

The Market Maker shall fulfill the applicable obligations and conditions as specified in the SEBI ICDR Regulations, as amended from time to time and the circulars issued by NSE and SEBI in this matter from time to time.

Following is a summary of the key details pertaining to the Market making arrangement:

- The Market Maker(s) (individually or jointly) shall be required to provide a 2-way quote for 75% of the time in a day. The same shall be monitored by the stock exchange. Further, the Market Maker(s) shall inform the exchange in advance for each and every black out period when the quotes are not being offered by the Market Maker(s).
- The prices quoted by Market Maker shall be in compliance with the Market Maker Spread Requirements and other particulars as specified or as per the requirements of the National Stock Exchange of India Limited (SME Platform of NSE) and SEBI from time to time.
- The minimum depth of the quote shall be Rs.1,00,000/-. However, the investors with holdings of value less than Rs. 1,00,000/- shall be allowed to offer their holding to the Market Maker(s) (individually or jointly) in that scrip provided that he sells his entire holding in that scrip in one lot along with a declaration to the effect to the selling broker.
- The Market Maker shall not sell in lots less than the minimum contract size allowed for trading on the SME Platform of NSE (in this case currently the minimum trading lot size is 1200 equity shares; however, the same may be changed by the SME Platform of NSE from time to time).
- After a period of three (3) months from the market making period, the Market Maker would be exempted to provide quote if the Shares of Market Maker in our company reaches to 25% of Issue Size. Any Equity Shares allotted to Market Maker under this Issue over and above 25% of Issue Size would not be taken in to consideration of computing the threshold of 25% of Issue Size. As soon as the Shares of Market Maker in our Company reduces to 24% of Issue Size, the Market Maker will resume providing 2 way quotes.
- There shall be no exemption/threshold on downside. However, in the event the Market Maker exhausts his inventory through market making process, NSE may intimate the same to SEBI after due verification.
- Execution of the order at the quoted price and quantity must be guaranteed by the Market Maker(s), for the quotes given by him.
- There would not be more than five Market Makers for a scrip at any point of time and the Market Makers may compete with other Market Makers for better quotes to the investors.
- On the first day of the listing, there will be pre-opening session (call auction) and there after the trading will happen as per the equity market hours. The circuits will apply from the first day of the listing on the discovered price during the pre-open call auction.
- The Market maker may also be present in the opening call auction, but there is no obligation on him to do so.
- There will be special circumstances under which the Market Maker may be allowed to withdraw temporarily/fully from the market – for instance due to system problems, any other problems. All controllable reasons require prior approval from the Exchange, while *force-majeure* will be applicable for non-controllable reasons. The decision of the Exchange for deciding controllable and non-controllable reasons would be final

- The Market Maker(s) shall have the right to terminate said arrangement by giving a six months' notice or on mutually acceptable terms to the Merchant Banker, who shall then be responsible to appoint a replacement Market Maker(s) and execute a fresh arrangement.
- In case of termination of the above-mentioned Market Making agreement prior to the completion of the compulsory Market Making period, it shall be the responsibility of the Book Running Lead Manager to arrange for another Market Maker in replacement during the term of the notice period being served by the Market Maker but prior to the date of releasing the existing Market Maker from its duties in order to ensure compliance with the requirements of regulation 261 of the SEBI (ICDR) Regulations, 2018, as amended. Further our Company and the Book Running Lead Manager reserve the right to appoint other Market Makers either as a replacement of the current Market Maker or as an additional Market Maker subject to the total number of Designated Market Makers does not exceed five or as specified by the relevant laws and regulations applicable at that particular point of time. The Market Making Agreement is available for inspection at our office from 10.00 a.m. to 5.00 p.m. on working days.
- **Risk containment measures and monitoring for Market Makers:** NSE Emerge Exchange will have all margins which are applicable on the NSE Main Board viz., Mark-to-Market, Value-At-Risk (VAR) Margin, Extreme Loss Margin, Special Margins and Base Minimum Capital etc. NSE can impose any other margins as deemed necessary from time-to-time.
- **Punitive Action in case of default by Market Makers:** The Exchange will monitor the obligations on a real time basis and punitive action will be initiated for any exceptions and/or non-compliances. Penalties / fines may be imposed by the Exchange on the Market Maker, in case he is not able to provide the desired liquidity in a particular security as per the specified guidelines. These penalties / fines will be set by the Exchange from time to time. The Exchange will impose a penalty on the Market Maker in case he is not present in the market (offering two-way quotes) for at least 75% of the time. The nature of the penalty will be monetary as well as suspension in market making activities / trading membership. The Department of Surveillance and Supervision of the Exchange would decide and publish the penalties / fines / suspension for any type of misconduct/ manipulation/ other irregularities by the Market Maker from time to time.
- **Price Band and Spreads:** The price band shall be 20% and the market maker spread (difference between the sell and the buy quote) shall be within 10% or as intimated by Exchange from time to time.
- Pursuant to SEBI Circular number CIR/MRD/DSA/31/2012 dated November 27, 2012, limits on the upper side for market makers during market making process has been made applicable, based on the Issue size and as follows:

Issue Size	Buy quote exemption threshold (including mandatory initial inventory of 5% of the Issue Size)	Re-Entry threshold for buy quote (including mandatory initial inventory of 5% of the Issue Size)
Up to ₹20 Crore	25%	24%
₹20 to ₹50 Crore	20%	19%
₹50 to ₹80 Crore	15%	14%
Above ₹80 Crore	12%	11%

The Market Making arrangement, trading and other related aspects including all those specified above shall be subject to the applicable provisions of law and/or norms issued by SEBI / NSE from time to time.

All the above-mentioned conditions and systems regarding the Market Making Arrangement are subject to change based on changes or additional regulations and guidelines from SEBI and Stock Exchange from time to time.

The SEBI Circular bearing reference no: CIR/MRD/DP/ 02/2012 dated January 20, 2012, has laid down that for issue size up to ₹250 crores, the applicable price bands for the first day shall be:

- i. In case equilibrium price is discovered in the Call Auction, the price band in the normal trading session shall be 5% of the equilibrium price.
- ii. In case equilibrium price is not discovered in the Call Auction, the price band in the normal trading session shall be 5% of the issue price.

Withdrawal of the Issue

Our Company in consultation with the Book Running Lead Manager, reserve the right to not to proceed with the Issue anytime after the Bid/ Issue Opening Date but before the allotment of Equity Shares, and in such case a public notice within 2 (two) working days of the Bid/ Issue Closing Date, providing reasons for not proceeding with the Issue shall be issued by our Company. The notice of withdrawal

will be issued in the same newspapers where the pre- Issue advertisements have appeared and the Stock Exchange will also be informed promptly. The BRLM, through the Registrar to the Issue, will instruct the SCSBs to unblock the ASBA Accounts within 1 (one) working Day from the day of receipt of such instruction.

If our Company withdraws the Issue after the Bid/ Issue Closing Date and subsequently decides to proceed with an Issue of the Equity Shares, our Company will have to file a fresh Draft Red Herring Prospectus with the stock exchange where the Equity Shares may be proposed to be listed.

Notwithstanding the foregoing, the Issue is subject to obtaining (i) the final listing and trading approvals of the Stock Exchange with respect to the Equity Shares issued through the Prospectus, which our Company will apply for only after Allotment; and (ii) filing of Red Herring Prospectus/ Prospectus with Registrar of Companies.

CAPITAL STRUCTURE

Set forth below are the details of the Share Capital of our Company as on the date of this Prospectus.

(Rs. in Lakhs, except share data)			
Sr. No.	Particulars	Aggregate Value at Face Value	Aggregate Value at Issue Price
A	Authorized Share Capital 1,20,00,000 Equity Shares having face value of Rs. 10/- each.	1200.00	-
B	Issued, Subscribed & Paid-up Share Capital prior to the Issue 80,00,000 Equity Shares having face value of ₹10/- each	800.00	-
C	Present Issue in terms of this Prospectus* 28,80,000 Equity Shares having face value of ₹ 10/-each at a Premium of ₹ 105 per share	288.00	3024.00
	Which comprises of:		
D	Reservation for Market Maker Portion 1,48,800 Equity Shares of ₹10/- each at a price of ₹105 per Equity Shares Share reserved as Market Maker Portion	14.88	156.24
E	Net Issue to Public Net Issue to Public of 27,31,200 Equity Shares of ₹10/- each at a price of ₹105 per Equity Shares Share to the Public	273.12	2867.76
	Of which:		
	i. At least 9,56,400 Equity Shares aggregating up to Rs. 1004.22 lakhs will be available for allocation to Retail Individual Investors	95.64	1004.22
	ii. At least 4,10,400 Equity Shares aggregating up to Rs. 430.92 lakhs will be available for allocation to Non-Institutional Investors	41.04	430.92
	iii. Not more than 13,64,400 Equity Shares aggregating up to Rs. 1432.62 lakhs will be available for allocation to Qualified Institutional Buyers, five per cent. of which shall be allocated to mutual funds.	136.44	1432.62
F	Issued, Subscribed and Paid up Equity Shares Share Capital after the Issue 1,08,80,000 Equity Shares of face value of ₹10/- each	1088.00	
G	Securities Premium Account		
	Before the Issue (as on date of this Prospectus)	71.60	
	After the Issue	2736.00	

¹ Subject to finalisation of the Basis of Allotment.

²The Present Issue of 28,80,000 Equity Shares in terms of this Prospectus has been authorized pursuant to a resolution of our Board of Directors dated May 01, 2024 and by special resolution passed under Section 62(1)(c) of the Companies Act, 2013 at an Extra Ordinary General Meeting of the members held on May 06, 2024.

Classes of Shares: -

Our Company has only one class of share capital i.e. Equity Shares of face value of Rs. 10/- each only. All the issued Equity Shares are fully paid-up. Our Company has no outstanding convertible instruments as on the date this Prospectus.

Notes to the Capital Structure:**1. Changes in Authorised Share Capital of our Company:****Equity Share Capital**

Sr. No.	Particulars of Changes	Cumulative No. of Equity Shares	Face Value of Equity Shares Share	Cumulative Authorized Share Capital (Rs. in lakhs)	Date of Shareholders' Meeting	Whether AGM/EGM
1.	Upon incorporation	5,00,000	10/-	50.00	On Incorporation	N.A.

2.	Increase in the authorized share capital of the Company from ₹50.00 Lakhs divided into 5,00,000 Equity Shares of ₹10/- each to ₹1200.00 Lakhs divided into 1,20,00,000 Equity Shares of ₹10/- each.	1,20,00,000	10/-	1200.00	January 16, 2024	EGM
----	---	-------------	------	---------	------------------	-----

2. Share Capital History of our Company:

a) Equity Shares capital

The following table sets forth details of the history of the Equity Shares capital of our Company:

Date of Allotment	No. of Equity Shares allotted	Face Value (₹)	Issue Price (including Premium if applicable) (₹)	Nature of Consideration	Nature of Allotment	Cumulative No. of Equity Shares	Cumulative Paid up Capital (₹)
Upon Incorporation	5,00,000	10	10	Cash	Subscription to MOA ⁽ⁱ⁾	5,00,000	50,00,000
January 18, 2024	35,00,000	10	Nil	Other than Cash	Bonus Issue in the ratio of 7:1 ⁽ⁱⁱ⁾	40,00,000	4,00,00,000
February 06, 2024	40,00,000	10	11.79	Cash	Right Issue ⁽ⁱⁱⁱ⁾	80,00,000	8,00,00,000

All the above mentioned shares are fully paid up since the date of allotment.

- (i) Initial Subscribers to the Memorandum of Association subscribed 5,00,000 Equity Shares of face value of Rs. 10/- each, details of which are given below:

Sr. No.	Name of Subscribers	Number of Equity Shares Subscribed
1.	Nitin Kumar Heda	2,50,000
2.	Prahladrai Ramdayal Heda	1,25,000
3.	Khushboo Manishkumar Heda	1,25,000
Total		5,00,000

- (ii) Bonus issue of 35,00,000 Equity Shares of face value of Rs. 10/- each in the ratio of 7:1 i.e. Seven (7) Bonus Equity Shares for every One (1) Equity Shares held by shareholders. (refer point no. 4 below for allottees list)

- (iii) Details of the Right Issue of 40,00,000 Equity Shares of face value of Rs. 10/- each at a premium of Rs. 1.79/- each as per details given below:

Sr. No.	Name of Allottee	Number of Equity Shares Allotted
1.	Nitin Kumar Heda	20,00,000
2.	Prahladrai Ramdayal Heda	10,00,000
3.	Khushboo Manishkumar Heda	10,00,000
Total		40,00,000

- b) **Preference Share Capital:** As on the date of this Prospectus, our Company does not have any issued Preference Share Capital.

3. Details of Allotment made in the last two years preceding the date of Prospectus

Except as mentioned in point number 2(a)(ii) & (iii) above, the Company has not issued any Equity Share in the last two years preceding the date of the Prospectus.

4. Issue of Equity Shares for consideration other than cash:

Except as set out below, we have not issued Equity Shares for consideration other than cash in last one year:

Date of Allotment	Number of Equity Shares	Face Value (Rs.)	Issue Price (Rs.)	Reasons for Allotment	Benefits Accrued to our Company	Name of Allottee	No. of Shares Allotted
January 18, 2024	35,00,000	10	Nil	Bonus Issue in the ratio of 7:1	Capitalization of Reserves & Surplus	Nitin Kumar Heda	17,50,000
						Prahladrai Ramdayal Heda	8,75,000
						Khushboo Manishkumar Heda	8,75,000
						Total	35,00,000

5. No Equity Shares have been allotted pursuant to any scheme approved under sections 230-234 of the Companies Act, 2013 or under the erstwhile corresponding provisions of the Companies Act, 1956.
6. Our Company has not issued any shares pursuant to an Employee Stock Option Scheme.
7. Except for Bonus Issue & Right Issue made on January 18, 2024 & February 06, 2024 respectively, our Company has not issued Equity Shares at price below the Issue price within last one year from the date of the Prospectus. (refer point no. 2(a)(ii) & (iii) above for allottees list)
8. We have not revalued our assets since inception and have not issued any Equity Shares (including bonus shares) by capitalizing any revaluation reserves.
9. **Shareholding Pattern of the Company**

The table below represents the shareholding pattern of our Company in accordance with Regulation 31 of the SEBI (Listing Obligations and Disclosure Requirements) Regulations, 2015, as on the date of this Prospectus:

I. Our Shareholding Pattern:-

Sr. No.	Category of shareholder	No. of share holders	No. of fully paid up Equity Shares held	No. of Partly paid up Equity Shares held	No. of shares underlying Depository Receipts	Total nos. shares held	Shareholding as a % of total no. of shares (calculated as per SCRR, 1957) As a % of (A+B+C2)	Number of Voting Rights held in each class of securities*				No. of Shares Underlying Outstanding convertible securities (including Warrants)	Shareholding, as a % assuming full conversion of convertible securities (as a percentage of diluted share capital) As a % of (A+B+C2)	Number of Locked in shares		Number of Shares pledged or otherwise encumbered		Number of Equity Shares held in dematerialized form
								No of Voting Rights			Total as a % of (A+B+C)			No. (a)	As a % of total Shares held (b)	No. (a)	As a % of total Share held (b)	
								Class Equity Shares of Rs.10/- each^	Classes eg: y	Total								
I	II	III	IV	V	VI	VII = IV+V+VI	VIII	IX				X	XI=VII+X	XII		XIII		XIV
(A)	Promoters & Promoter Group	7	80,00,000	-	-	80,00,000	100.00	80,00,000	-	80,00,000	100.00	-	-	-	-	-	-	80,00,000
(B)	Public	-	-	-	-	-	-	-	-	-	-	-	-	-	-	-	-	-
(C)	Non-Promoter-Non Public	-	-	-	-	-	-	-	-	-	-	-	-	-	-	-	-	-
(C1)	Shares underlying DRs	-	-	-	-	-	-	-	-	-	-	-	-	-	-	-	-	-
(C2)	Shares held by Emp. Trusts	-	-	-	-	-	-	-	-	-	-	-	-	-	-	-	-	-
	Total	7	80,00,000	-	-	80,00,000	100.00	80,00,000	-	80,00,000	100.00	-	-	-	-	-	-	80,00,000

The term "Encumbrance" has the same meaning as assigned under regulation 28(3) of SEBI (Substantial Acquisition of Shares and Takeovers) Regulations, 2011.

Notes-

- As on date of this Prospectus 1 Equity share holds 1 vote.
- We have only one class of Equity Shares of face value of Rs. 10/- each.
- We have entered into tripartite agreement with CDSL & NSDL.
- Our Company will file the shareholding pattern in the format prescribed under Regulation 31 of the SEBI (Listing Obligations and Disclosure Requirements), Regulations, 2015, one day prior to the listing of the Equity Shares. The shareholding pattern will be uploaded on the Website of the NSE before commencement of trading of such Equity Shares.

10. List of Shareholders of the Company holding 1% or more of the paid up Share Capital of the Company:-

a) As on the date of filing of this Prospectus: -

Sr. No.	Names of Shareholders	Equity Shares held (Face Value of Rs. 10 each)	% Pre Issue paid up Share Capital
1.	Nitin Kumar Heda	3,999,800	50.00
2.	Prahladrai Ramdayal Heda	1,999,900	25.00
3.	Khushboo Manishkumar Heda	1,999,900	25.00
	Total	79,99,600	100.00

b) Ten days prior to the date of filing of this Prospectus: -

Sr. No.	Names of Shareholders	Equity Shares held (Face Value of Rs. 10 each)	% Pre Issue paid up Share Capital
1.	Nitin Kumar Heda	3,999,800	50.00
2.	Prahladrai Ramdayal Heda	1,999,900	25.00
3.	Khushboo Manishkumar Heda	1,999,900	25.00
	Total	79,99,600	100.00

c) One Year prior to the date of filing of this Prospectus: -

Sr. No.	Names of Shareholders	Equity Shares held (Face Value of Rs. 10 each)	% Pre Issue paid up Share Capital
1.	Nitin Kumar Heda	249,998	50.00
2.	Prahladrai Ramdayal Heda	124,999	25.00
3.	Khushboo Manishkumar Heda	124,999	25.00
	Total	4,99,996	100.00

*Details of shares held on August 16, 2023 and percentage held has been calculated based on the paid up capital of our Company as on August 16, 2023.

d) Two Years prior to the date of filing of this Prospectus: -

Sr. No.	Names of Shareholders	Equity Shares held (Face Value of Rs. 10 each)	% Pre Issue paid up Share Capital
1.	Nitin Kumar Heda	2,50,000	50.00
2.	Prahladrai Ramdayal Heda	1,25,000	25.00
3.	Khushboo Manishkumar Heda	1,25,000	25.00
	Total	5,00,000	100.00

*Details of shares held on August 16, 2022 and percentage held has been calculated based on the paid up capital of our Company as on August 16, 2022.

11. Our Company has not made any Initial Public Offer of specified securities in the preceding two years from the date of filing of this Prospectus.

12. There will be no further issue of capital, whether by way of issue of bonus shares, preferential allotment, Right issue or in any other manner during the period commencing from the date of the Prospectus until the Equity Shares of our Company have been listed or application money unblocked on account of failure of Issue. Further, our Company does not intend to alter its capital structure within six months from the date of opening of the offer, by way of split / consolidation of the denomination of Equity Shares. However, our Company may further issue equity shares (including issue of securities convertible into Equity Shares) whether preferential or otherwise after the date of the listing of equity shares to finance an acquisition, merger or joint venture or for regulatory compliance or such other scheme of arrangement or any other purpose as the Board of Directors may deem fit, if an opportunity of such nature is determined by the Board of Directors to be in the interest of our Company.

13. Capital Build-up in respect of Shareholding of our Promoters

As on the date of this Prospectus, Our Promoters, Nitin Kumar Heda, Prahladrai Ramdayal Heda, Khushboo Manishkumar Heda and Manish Kumar Heda collectively hold 79,99,600 Equity Shares of our Company. None of the Equity Shares held by our Promoters are subject to any pledge.

Set forth below is the build-up of the shareholding of our Promoters in our Company since incorporation.

Date of Allotment and paid up/ Transfer	No. of Equity Shares	Face Value Per Share (₹)	Issue/ Acquisition/ Transfer Price (₹)	Consideration	Nature of Acquisition	Pre-Issue Shareholding % (adjusted as per face value)	Post-Issue Shareholding % (adjusted as per face value)
(A) Nitin Kumar Heda							
August 04, 2022	2,50,000	10	10	Cash	Subscriber to MOA	3.13%	2.30%
September 15, 2022	(2)	10	10	Cash	Transfer of shares ^(a)	(0.00%)	(0.00%)
November 21, 2023	2	10	10	Cash	Acquisition by way of Transfer of shares ^(b)	0.00%	0.00%
January 18, 2024	17,50,000	10	Nil	Other than Cash	Bonus Issue in the ratio of 7:1	21.88%	16.08%
February 06, 2024	20,00,000	10	11.79	Cash	Right Issue	25.00%	18.38%
February 06, 2024	(200)	10	10	Cash	Transfer of shares ^(c)	(0.00%)	(0.00%)
Total (A)	39,99,800					50.00%	36.76%
(B) Prahladrai Ramdayal Heda							
August 04, 2022	1,25,000	10	10	Cash	Subscriber to MOA	1.56%	1.15%
September 15, 2022	(1)	10	10	Cash	Transfer of shares ^(d)	(0.00%)	(0.00%)
November 21, 2023	1	10	10	Cash	Acquisition by way of Transfer of shares ^(e)	0.00%	0.00%
January 18, 2024	8,75,000	10	Nil	Other than Cash	Bonus Issue in the ratio of 7:1	10.94%	8.04%
February 06, 2024	10,00,000	10	11.79	Cash	Right Issue	12.50%	9.19%
February 06, 2024	(100)	10	10	Cash	Transfer of shares ^(f)	(0.00%)	(0.00%)
Total (B)	19,99,900					25.00%	18.38%
(C) Khushboo Manishkumar Heda							
August 04, 2022	1,25,000	10	10	Cash	Subscriber to MOA	1.56%	1.15%
September 15, 2022	(1)	10	10	Cash	Transfer of shares ^(g)	(0.00%)	(0.00%)
November 21, 2023	1	10	10	Cash	Acquisition by way of Transfer of shares ^(h)	0.00%	0.00%
January 18, 2024	8,75,000	10	Nil	Other than Cash	Bonus Issue in the ratio of 7:1	10.94%	8.04%
February 06, 2024	10,00,000	10	11.79	Cash	Right Issue	12.50%	9.19%
February 06, 2024	(100)	10	10	Cash	Transfer of shares ⁽ⁱ⁾	(0.00%)	(0.00%)
Total (C)	19,99,900					25.00%	18.38%
(D) Manish Kumar Heda							
-	-	-	-	-	-	0.00	0.00%
Total (D)						0.00	0.00%
Grand Total (A+B+C+D)	79,99,600					100.00%	73.53%

Note: None of the Shares has been pledged by our Promoters.

a) Details of sale of Shares by Nitin Kumar Heda of 2 Equity Shares dated September 15, 2022.

Sr. No.	Date of Transfer	Name of Transferee	No. of Shares Transferred
1.	September 15, 2022	Akshaykumar Ramdayal Heda HUF	1

2.	September 15, 2022	Nitinkumar Akshaykumar Heda HUF	1
		Total	2

b) Details of acquisition by Nitin Kumar Heda by way of transfer of 2 Equity Shares dated November 21, 2023.

Sr. No.	Date of Transfer	Name of Transferor	No. of Shares Transferred
1.	November 21, 2023	Akshaykumar Ramdayal Heda HUF	1
2.	November 21, 2023	Nitinkumar Akshaykumar Heda HUF	1
		Total	2

c) Details of sale of Shares by Nitin Kumar Heda of 200 Equity Shares dated February 06, 2024.

Sr. No.	Date of Transfer	Name of Transferee	No. of Shares Transferred
1.	February 06, 2024	Akshaykumar Ramdayal Heda HUF	100
2.	February 06, 2024	Nitinkumar Akshaykumar Heda HUF	100
		Total	200

d) Details of sale of Shares by Prahladrai Ramdayal Heda of 1 Equity Shares dated September 15, 2022.

Sr. No.	Date of Transfer	Name of Transferee	No. of Shares Transferred
1.	September 15, 2022	Prahladrai Ramdayal Heda HUF	1
		Total	1

e) Details of acquisition by Prahladrai Ramdayal Heda by way of transfer of 1 Equity Shares dated November 21, 2023.

Sr. No.	Date of Transfer	Name of Transferor	No. of Shares Transferred
1.	November 21, 2023	Prahladrai Ramdayal Heda HUF	1
		Total	1

f) Details of sale of Shares by Prahladrai Ramdayal Heda of 100 Equity Shares dated February 06, 2024.

Sr. No.	Date of Transfer	Name of Transferee	No. of Shares Transferred
1.	February 06, 2024	Prahladrai Ramdayal Heda HUF	100
		Total	100

g) Details of sale of Shares by Khushboo Manishkumar Heda of 1 Equity Shares dated September 15, 2022.

Sr. No.	Date of Transfer	Name of Transferee	No. of Shares Transferred
1.	September 15, 2022	Manishkumar Akshaykumar Heda HUF	1
		Total	1

h) Details of acquisition by Khushboo Manishkumar Heda by way of transfer of 1 Equity Shares dated November 21, 2023.

Sr. No.	Date of Transfer	Name of Transferor	No. of Shares Transferred
1.	November 21, 2023	Manishkumar Akshaykumar Heda HUF	1
		Total	1

i) Details of sale of Shares by Khushboo Manishkumar Heda of 100 Equity Shares dated February 06, 2024.

Sr. No.	Date of Transfer	Name of Transferee	No. of Shares Transferred
1.	February 06, 2024	Manishkumar Akshaykumar Heda HUF	100
		Total	100

14. The average cost of acquisition of or subscription of shares by our Promoters is set forth in the table below:

Sr. No.	Name of the Promoters	No. of Shares held	Average cost of Acquisition (in ₹)
1.	Nitin Kumar Heda	3,999,800	6.52
2.	Prahladrai Ramdayal Heda	1,999,900	6.52
3.	Khushboo Manishkumar Heda	1,999,900	6.52
4.	Manish Kumar Heda	-	NA

15. Shareholding of Promoters & Promoter Group

Following are the details of pre and post Issue shareholding of persons belonging to the category “Promoters and Promoter Group”:

Sr. No	Names	Pre IPO		Post IPO	
		Shares Held	% Shares Held	Shares Held	% Shares Held
	Promoters				
1.	Nitin Kumar Heda	3,999,800	50.00	3,999,800	36.76
2.	Prahladrai Ramdayal Heda	1,999,900	25.00	1,999,900	18.38
3.	Khushboo Manishkumar Heda	1,999,900	25.00	1,999,900	18.38
4.	Manish Kumar Heda	-	0.00	-	0.00
	Total of P & PG (A)	79,99,600	100.00	79,99,600	73.53
	Promoter Group				
5.	Akshaykumar Ramdayal Heda HUF	100	0.00	100	0.00
6.	Nitinkumar Akshaykumar Heda HUF	100	0.00	100	0.00
7.	Prahladrai Ramdayal Heda HUF	100	0.00	100	0.00
8.	Manishkumar Akshaykumar Heda HUF	100	0.00	100	0.00
	Sub Total (B)	400	0.00	400	0.00
	Grand Total (A+B)	80,00,000	100.00	80,00,000	73.53

16. Except as provided below, no Equity Shares were purchased/ sold by the Promoters and Promoter Group, Directors and their immediate relatives within six months immediately preceding the date of filing of this Prospectus.

Date of Transfer	Name of Shareholders	No. of Equity Share	% of Pre issue Capital	Purchase/ Sale of Equity Share	Category of Allottees (Promoters/ Promoter Group/ Director)
February 06, 2024	Nitin Kumar Heda	(200)	(0.00%)	Transfer of shares	Promoter & Director
	Prahladrai Ramdayal Heda	(100)	(0.00%)	Transfer of shares	Promoter & Director
	Khushboo Manishkumar Heda	(100)	(0.00%)	Transfer of shares	Promoter & Director
	Akshaykumar Ramdayal Heda HUF	100	0.00	Acquisition of Shares	Promoter Group
	Nitinkumar Akshaykumar Heda HUF	100	0.00	Acquisition of Shares	Promoter Group
	Prahladrai Ramdayal Heda HUF	100	0.00	Acquisition of Shares	Promoter Group
	Manishkumar Akshaykumar Heda HUF	100	0.00	Acquisition of Shares	Promoter Group

17. None of our Promoters, Promoter Group, our Directors and their relatives has entered into any financing arrangement or financed the purchase of the Equity Shares of our Company by any other person during the period of six months immediately preceding the date of filing of the Prospectus.

18. Details of Promoter’ Contribution Locked-in for Three Years

Pursuant to Regulation 236 and 238 of SEBI (ICDR) Regulations, 2018, an aggregate of 20.00% of the post issue capital held by our Promoters shall be considered as Promoter’s Contribution (“Promoters Contribution”) and shall be locked-in for a period of three years from the date of allotment of Equity Shares issued pursuant to this Issue. The lock in of Promoter’s Contribution would be created as per applicable law and procedure and details of the same shall also be provided to the Stock Exchange before listing of the Equity Shares.

As on the date of this Prospectus, our Promoters hold 79,99,600 Equity Shares constituting 73.53% of the Post – Issued, subscribed and paid up Equity Shares Share Capital of our Company, which are eligible for the Promoter’ contribution.

Our Promoters, Nitin Kumar Heda, Prahladrai Ramdayal Heda and Khushboo Manishkumar, have given written consent to include 22,00,000 Equity Shares held by them as part of Promoters Contribution constituting 20.22% of the post issue Equity Shares of our Company. Further, they have agreed not to sell or transfer or pledge or otherwise dispose of in any manner, the Promoters contribution, for a period of three years from the date of allotment in the Issue.

Date of Allotment/ Transfer and made fully Paid Up	No. of Equity Shares locked-in*	Face Value Per Share (₹)	Issue/ Acquisition/ Transfer Price (₹)	Nature of transaction	Post-Issue Shareholding %	Lock in Period
Nitin Kumar Heda						
January 18, 2024	11,00,000	10	-	Bonus Issue (7:1)	10.11	3 years
Prahladrai Ramdayal Heda						
January 18, 2024	5,50,000	10	-	Bonus Issue (7:1)	5.06	3 years
Khushboo Manishkumar Heda						
January 18, 2024	5,50,000	10	-	Bonus Issue (7:1)	5.06	3 years

*Assuming full subscription to the Issue.

The minimum Promoter's contribution has been brought in to the extent of not less than the specified minimum lot and from persons defined as "Promoter" under the SEBI (ICDR) Regulations. All Equity Shares, which are being locked in are not ineligible for computation of Minimum Promoters Contribution as per Regulation 237 of the SEBI (ICDR) Regulations, 2018 and are being locked in for 3 years as per Regulation 238(a) of the SEBI (ICDR) Regulations, 2018 i.e. for a period of three years from the date of allotment of Equity Shares in this issue.

The entire pre-issue shareholding of the Promoter, other than the Minimum Promoters contribution which is locked in for three years, shall be locked in for a period of one year from the date of allotment in this Issue.

Eligibility of Share for "Minimum Promoter Contribution in terms of clauses of Regulation 237(1) of SEBI (ICDR) Regulations, 2018

Reg. No.	Promoter' Minimum Contribution Conditions	Eligibility Status of Equity Shares forming part of Promoter's Contribution
237(1)(a) (i)	Specified securities acquired during the preceding three years, if they are acquired for consideration other than cash and revaluation of assets or capitalization of intangible assets is involved in such transaction	The minimum Promoter's contribution does not consist of such Equity Shares. Hence Eligible
237(1)(a)(ii)	Specified securities acquired during the preceding three years, resulting from a bonus issue by utilization of revaluation reserves or unrealized profits of the issuer or from bonus issue against Equity Shares which are ineligible for minimum Promoter' contribution	The minimum Promoter's contribution does not consist of such Equity Shares. Hence Eligible
237(1)(b)	Specified securities acquired by promoters during the preceding one year at a price lower than the price at which specified securities are being offered to public in the initial public offer	The minimum Promoter's contribution does not consist of such Equity Shares. Hence Eligible
237(1)(c)	Specified securities allotted to promoters during the preceding one year at a price less than the issue price, against funds brought in by them during that period, in case of an issuer formed by conversion of one or more partnership firms, where the partners of the erstwhile partnership firms are the promoters of the issuer and there is no change in the management: Provided that specified securities, allotted to promoters against capital existing in such firms for a period of more than one year on a continuous basis, shall be eligible	The minimum Promoter's contribution does not consist of such Equity Shares. Hence Eligible
237(1)(d)	Specified securities pledged with any creditor.	Our Promoters have not Pledged any shares with any creditors. Accordingly, the minimum Promoter's contribution does not consist of such Equity Shares. Hence Eligible

Details of Promoter' Contribution Locked-in for One Year

In terms of Regulation 238(b) and 239 of the SEBI (ICDR) Regulations, 2018, in addition to the Minimum Promoter contribution which is locked in for three years, as specified above, the entire pre-issue Equity Shares share capital constituting 58,00,000 Equity Shares shall be locked in for a period of one year from the date of allotment of Equity Shares in this Issue.

In terms of Regulation 241 of the SEBI (ICDR) Regulations, 2018, the Equity Shares which are subject to lock-in shall carry inscription 'non-transferable' along with the duration of specified non-transferable period mentioned in the face of the security certificate. The shares which are in dematerialized form, if any, shall be locked-in by the respective depositories. The details of lock-in of the Equity Shares shall also be provided to the Designated Stock Exchange before the listing of the Equity Shares.

Other requirements in respect of lock-in:

1. In terms of Regulation 242 of the SEBI (ICDR) Regulations, 2018 the locked in Equity Shares held by the Promoters, as specified above, can be pledged with any scheduled commercial bank or public financial institution or a systemically important non-banking finance company or a housing finance company as collateral security for loan granted by such bank or institution provided that the pledge of Equity Shares is one of the terms of the sanction of the loan. Provided that securities locked in as minimum promoter contribution may be pledged only if, in addition to fulfilling the above requirements, the loan has been granted by such bank or institution, for the purpose of financing one or more of the objects of the Issue.
2. In terms of Regulation 243 of the SEBI (ICDR) Regulations, 2018 the Equity Shares held by persons other than the Promoters prior to the Issue may be transferred to any other person holding the Equity Shares which are locked in as per Regulation 239 of the SEBI (ICDR) Regulations, 2018 subject to continuation of the lock-in in the hands of the transferees for the remaining period and compliance with the SEBI (Substantial Acquisition of Shares and Takeovers) Regulations, 2011, as applicable.
3. Further in terms of Regulation 243 of the SEBI (ICDR) Regulations, 2018 the specified securities held by the promoters and locked-in as per regulation 238 may be transferred to another promoter or any person of the promoter group or a new promoter or a person in control of the issuer subject to continuation of the lock-in in the hands of the transferees for the remaining period and compliance with SEBI (Substantial Acquisition of Shares and Takeovers) Regulations, 2011, as applicable.
19. Neither, we nor our Promoters, Directors and the BRLM to this Issue have entered into any buyback and/ or standby arrangements and/ or similar arrangements for the purchase of our Equity Shares from any person.
20. As on the date of this Prospectus, the entire Issued Share, Subscribed and Paid-up Share Capital of our Company is fully paid up. Since the entire issue price in respect of the issue is payable on application, all the successful applicants will be allotted fully paid- up Equity shares.
21. The BRLM i.e., Hem Securities Limited and their associates do not hold any Equity Shares in our Company as on the date of filing of this Prospectus.
22. As on the date of this Prospectus, we do not have any Employees Stock Option Scheme / Employees Stock Purchase Scheme and we do not intend to allot any shares to our employees under Employee Stock Option Scheme/ Employee Stock Purchase Plan from the proposed issue. As and when, options are granted to our employees under the Employee Stock Option Scheme, our Company shall comply with the SEBI (Share Based Employee Benefits) Regulations, 2014.
23. We have 7 (Seven) shareholders as on the date of filing of this Prospectus.
24. As on the date of filing of this Prospectus, there are no outstanding warrants, options or rights to convert debentures, loans or other instruments which would entitle Promoters or any shareholders or any other person any option to acquire our Equity Shares after this Initial Public Offer.
25. Our Company has not raised any bridge loan against the proceeds of the Issue.
26. As on the date of this Prospectus, none of the shares held by our Promoters/ Promoter Group are subject to any pledge.
27. We here by confirm that there will be no further issue of capital whether by way of issue of bonus shares, preferential allotment, rights issue or in any other manner during the period commencing from the date of the Prospectus until the Equity Shares offered have been listed or application money unblocked on account of failure of Issue.
28. An over-subscription to the extent of 1% of the Issue subject to the maximum post issue paid up capital of Rs. 25 cr. can be retained for the purpose of rounding off to the nearest integer during finalizing the allotment, subject to minimum allotment, which is the minimum application size in this Issue. Consequently, the actual allotment may go up by a maximum of 1% of the Issue, as a result of which, the post-issue paid up capital after the Issue would also increase by the excess amount of allotment so made. In such an event, the Equity Shares held by the Promoters and subject to 3-year lock- in shall be suitably increased; so as to ensure that 20% of the post Issue paid-up capital is locked in.
29. Under-subscription, if any, in any category, except in the QIB Portion, would be allowed to be met with spill over from any other category or a combination of categories at the discretion of our Company, in consultation with the BRLM and the Designated Stock Exchange. Such inter-se spill over, if any, would be effected in accordance with applicable laws, rules, regulations and guidelines. Under-subscription, if any, in the QIB Category will not be allowed to be met with spill over from any category or combination thereof.

- 30.** In case of over-subscription in all categories the allocation in the issue shall be as per the requirements of Regulation 253 of SEBI (ICDR) Regulations, 2018 and its amendments from time to time.
- 31.** At any given point of time there shall be only one denomination of the Equity Shares, unless otherwise permitted by law.
- 32.** Our Company shall comply with such disclosure and accounting norms as may be specified by NSE, SEBI and other regulatory authorities from time to time.
- 33.** There are no Equity Shares against which depository receipts have been issued.
- 34.** Other than the Equity Shares, there is no other class of securities issued by our Company.
- 35.** There are no safety net arrangements for this public issue.
- 36.** As per RBI regulations, OCBs are not allowed to participate in this issue.
- 37.** Our Promoter and Promoter Group will not participate in this Issue.
- 38.** This Issue is being made through Book Building Method.
- 39.** Our Company has not made any public issue or rights issue of any kind or class of securities since its incorporation.
- 40.** In terms of Rule 19(2)(b)(i) of the Securities Contracts (Regulation) Rules, 1957, as amended, (the SCRR) the Issue is being made for at least 25% of the post-issue paid-up Equity Share capital of our Company. Further, this Issue is being made in terms of Chapter IX of the SEBI (ICDR) Regulations, 2018, as amended from time to time.
- 41.** No person connected with the Issue shall offer any incentive, whether direct or indirect, in the nature of discount, commission, and allowance, or otherwise, whether in cash, kind, services or otherwise, to any Applicant.

We shall ensure that transactions in Equity Shares by the Promoters and members of the Promoter Group, if any, between the date of filing the Prospectus with the Registrar of Companies and the Issue Closing Date are reported to the Stock Exchanges within 24 hours of such transactions being completed.

OBJECTS OF THE ISSUE

The Issue includes a fresh Issue of 28,80,000 Equity Shares of our Company at an Issue Price of ₹105 per Equity Share. We intend to utilize the proceeds of the Issue to meet the following objects:

1. Funding of capital expenditure towards installation of new Plant & Machinery.
2. Repayment and/or pre-payment, in full or part, of certain borrowings availed by our Company.
3. General Corporate Purpose.

(Collectively referred as the “Objects”)

We believe that listing will enhance our corporate image and visibility of brand name of our Company. We also believe that our Company will receive the benefits from listing of Equity Shares on the SME Platform of NSE (NSE Emerge). It will also provide liquidity to the existing shareholders and will also create a public trading market for the Equity Shares of our Company.

Net Proceeds

The details of the Net Proceeds are set forth below:

		(₹ in Lakhs)
Particulars	Amount	
Gross Proceeds of the Issue	3024.00	
Less: Issue related expenses in relation to Issue	285.94	
Net Proceeds	2738.06	

Requirement of Funds and Utilization of Net Proceeds

The Net Proceeds are proposed to be used in accordance with the details as set forth below:

		(₹ in Lakhs)
S. No.	Particulars	Amount
1.	Funding of capital expenditure towards installation of new Plant & Machinery	404.55
2.	Repayment and/or pre-payment, in full or part, of certain borrowings availed by our Company;	1580.00
3.	General Corporate Purpose	725.51
	Total	2710.06

Our fund requirements and deployment thereof are based on internal management estimates of our current business plans and have not been appraised by any bank or financial institution. These are based on current conditions and are subject to change in light of changes in external circumstances or costs or in other financial conditions, business strategy, as discussed further below.

Means of Finance

We intend to finance our Objects of Issue through Net Issue Proceeds which is as follows:

		(₹ in Lakhs)
Sr. No	Particulars	Amount
1.	Net Issue Proceeds	2710.06
	Total	2710.06

Since, the entire fund requirement is to be funded from the proceeds of the Issue, there is no requirement to make firm arrangements of finance under Regulation 230(1)(e) of the SEBI ICDR Regulations through verifiable means towards at least 75% of the stated means of finance, excluding the amounts to be raised through the proposed Issue.

Subject to applicable law, if the actual utilization towards the Objects is lower than the proposed deployment, such balance will be used for general corporate purposes to the extent that the total amount to be utilised towards general corporate purposes will not exceed 25% of the Gross Proceeds in accordance with Regulation 7(2) of the SEBI ICDR Regulations. In case of a shortfall in raising the requisite capital from the Net Proceeds or an increase in the total estimated cost of the Objects, business considerations may require us to explore a range of options including utilizing our internal accruals and seeking additional debt from existing and/or future lenders. We believe that such alternate arrangements would be available to fund any such shortfalls. Further, in case of variations in the actual utilisation of funds earmarked for the purpose set forth above, increased funding requirements for a particular purpose may be financed by surplus funds, if any, available in respect of other purposes for which funds are being raised in the Fresh Issue. Any variation in the utilisation of the Net Proceeds as disclosed in this Prospectus shall be subject to certain compliance requirements, including prior approval of the shareholders of our Company. The Objects may be varied in the manner provided in “Objects of the Issue – Variation in Objects” on page 70 of this Prospectus. However, we confirm that no bridge financing has been availed as on date, which is subject to being repaid from the Issue Proceeds.

As we operate in competitive environment, our Company may have to revise its business plan from time to time and consequently our fund requirements may also change. Our Company's historical expenditure may not be reflective of our future expenditure plans. Our Company may have to revise its estimated costs, fund allocation and fund requirements owing to various factors such as economic and business conditions, increased competition and other external factors which may not be within the control of our management. This may entail rescheduling or revising the planned expenditure and funding requirements, including the expenditure for a particular purpose at the discretion of the Company's management.

For further details on the risks involved in our business plans and executing our business strategies, please see the section titled "**Risk Factors**" beginning on page 25 of this Prospectus.

Details of Utilization of Net Proceeds

The details of utilization of the Net Proceeds are set forth herein below:

1. Funding of capital expenditure towards installation of new Plant & Machinery:

As on the date of this Prospectus, our existing manufacturing unit is located at Survey No. 270A & Plot No. 1, Survey No. 267, Chhatha Mile, Dantali, Vaso, Kheda -387350, Gujarat, India admeasuring the total area of 12,152 sq. mtr., where we are manufacturing of copper rods & wires, copper earthing wires, copper earthing strips, copper conductors, copper wire bars etc.

The fund requirements, the deployment of funds and the intended use of the Net Proceeds, for buying the machineries, as described herein are based on our current business plan, current and valid quotations from suppliers, and other commercial and technical factors. However, such total estimated cost and related fund requirements have not been appraised by any bank or financial institution or any other independent agency.

Our Company proposes to acquire plant and machinery at an estimated cost of ₹404.55 Lakhs. Our Company has identified the type of plant and machinery to be purchased for existing manufacturing unit and obtained quotations from vendor but we are yet to place order for 100% of the plant and machinery. The detailed list of plant & machinery to be acquired by our Company is provided below:

Date of Quotation/ Performa Invoice	Name of Plant & Machinery	Supplier Name	No of Machines	Validity from date of Quotation	Amount (Rs. In Lakhs)
March 15, 2024	Hydraulic Drawing & Tension Straightening Machine	Shanghai Yajue Machinery Manufacturing Co. Ltd. China	1	12 months	141.97
June 19, 2024	High Speed electrolytic tinning machine	Zhangjiagang Mentors Machinery Co. Ltd., China	1	3 months	148.08
	Fine Wire Drawing Machine		5		88.61
	Double Twist Bunching Machine		2		25.89
Total					404.55

As per Quotation received from Suppliers

The Quotation was received in US\$. (Source – (1 US\$ = 83.51 INR) www.xe.com dated May 08, 2024)

Notes:

- We have considered the above quotations for the budgetary estimate purpose and have not placed orders for them. The actual cost of procurement and actual supplier/dealer may vary.
- Quotation received from the vendor mentioned above is valid as on date. However, we have not entered into any definitive agreements with vendor and there can be no assurance that the same vendor would be engaged to eventually supply the Plant & Machinery or at the same costs. If there is any increase in the costs, the additional costs shall be paid by our Company from its internal accruals see "**Risk Factor– "If there are delays in setting up the Proposed Facilities or if the costs of setting up and the possible time or cost overruns related to the Proposed Facilities or the purchase of plant and machinery for the Proposed Facilities are higher than expected, it could have a material adverse effect on our financial condition, results of operations and growth"**" on page 26 of this Prospectus.
- The Plant & machinery models and quantity to be purchased is based on the present estimates of our management. The Management shall have the flexibility to revise such estimates (including but not limited to change of machinery or vendor or

any modification/addition/deletion) at the time of actual placement of the order. In such case, the Management can utilize the surplus of proceeds, if any, arising at the time of actual placement of the order, to meet the cost of such other machinery, equipments or utilities, as required. Furthermore, if any surplus from the proceeds remains after meeting the total cost of Machinery, equipment's and utilities for the aforesaid purpose, the same will be used for our general corporate purposes, subject to limit of 25% of the amount raised by our Company through this Issue.

- d) We are not acquiring any second-hand machinery.
- e) The quotations relied upon by us in arriving at the above cost are valid for a specific period of time and may lapse after the expiry of the said period. Consequent upon which, there could be a possible escalation in the cost of Machinery proposed to be acquired by us at the actual time of purchase, resulting in increase in the estimated cost. Further, cost will be escalated on account of freight expenses, installation charges, packaging & forwarding, exchange rate fluctuations, custom duty etc. Such cost escalation would be met out of our internal accruals.

Detail and use of new products to be manufactured is briefed as under:

Copper flat bus-bar: Copper flat Busbars are flat, rectangular strips or bars made from copper that are used to conduct electricity within electrical equipment. They serve as a common electrical conductor to distribute power within switchboards, panel boards, distribution boards, and other electrical devices. Busbars are used to distribute electrical power from a main source (such as a transformer or generator) to various loads and circuits within a building or facility.

Tinned Copper Wire and Tinned Coated Bunched Copper Wire: Tinned copper wire has electrical properties suitable for power generation, transmission, distribution and electronic industries. It is in significant demand due to its extensive use across such industries owing to its corrosion resistance and durability. In electrical applications, tinned copper wire is ideal for marine wiring, solar power systems, and automotive wiring, where it withstands harsh environments and oxidation. It ensures reliable connections on printed circuit boards (PCBs) and is commonly used as hook-up wire due to its ease of soldering. It also plays a crucial role in power generation and distribution industries, enhancing conductivity and durability in transformer windings and power cables.

The proposed Schedule of Implementation for capital expenditure towards installation of new plant & Machinery is as follows:

Particular	Estimated month of Completion
Order of Plant & Machinery	August 2024
Delivery of Plant & Machinery	September 2024
Installation of Plant & Machinery	October 2024
Trial Run	October 2024
Commercial Operation	November 2024

Further, we hereby confirm that, company has received order inquiries from various industries seeking price quotations for tinned copper wire and tinned coated bunched copper wire.

2. Repayment and/or pre-payment, in full or part, of certain borrowings availed by our Company;

As on March 31, 2024, our total outstanding fund-based borrowings amounted to ₹ 3103.94 Lakhs. Our Company proposes to utilise an estimated amount of ₹ 1580.00 Lakhs proceeds towards full or partial repayment or pre-payment of certain borrowings availed from the lenders.

Our Company has entered into various financial arrangements from time to time, with banks and financial institutions. The loan facilities availed by our Company include borrowing in the form of, inter alia, term loans and working capital facility from various lenders. For further details, see “*Statement of Financial Indebtedness*” on page 182 of this Prospectus. Our Company proposes to utilise an estimated amount of ₹ 1580.00 Lakhs from the Net Proceeds towards full or partial repayment or pre-payment of certain borrowings, listed below, availed from the lender by our Company i.e. HDFC Bank Limited. Pursuant to the terms of the financing arrangements, prepayment of certain borrowings may attract prepayment charges as prescribed by the respective lender. Such prepayment charges, as applicable, will be funded from the internal accruals of our Company.

We believe that such repayment/ pre-payment will help reduce our outstanding indebtedness, debt servicing costs, assist us in maintaining a favourable debt to equity ratio and enable utilisation of our internal accruals for further investment in our business growth and expansion. Additionally, we believe that the leverage capacity of our Company will improve our ability to raise further resources in the future to fund our potential business development opportunities and plans to grow and expand our business.

The details of the borrowings availed by our Company, which are proposed to be fully or partially repaid or pre-paid from the Net Proceeds is mentioned below:

Rs. in Lakhs

Sr. No.	Name of the lender	Purpose	Loan/Agreement A/c No./ Ref. No.	Sanctioned amount	Date of availing/Dibursement of the loans	Amount Outstanding as at May 07, 2024	Rate of interest (%) – P.A.	Repayment date/ Schedule	Prepayment Penalty	Amount to be funded
1.	HDF C Bank Limited	Working Capital Demand Loan	5020007 3104369	3500.00	Last amended as on September 11, 2023	1580.74	8.63%	Repayable on Demand	N.A.	1400.00
2.	HDF C Bank Limited	Working capital Term Loan (Guaranteed Emergency Credit Line) Extn.	4519852 44 dated	225.59	January 03, 2022	203.92	9.25%	Repayable on monthly equitable installment for 61 months. Interest payment only for first 24 installments and afterwards 36 installments of Rs.7.10 lakhs each and last installment of Rs. 4.36 lakhs.	N.A.	180.00
Total										1580.00

Note: The details included in the above table have been certified by *M/s. Abhishek Kumar & Associates*, Statutory Auditors of the company, pursuant to their certificate dated May 08, 2024

Our Statutory Auditors by way of their certificate dated May 08, 2024, have confirmed that the borrowings specified above has been utilized for the purposes availed, as per the sanction letters/loan agreements issued by the respective banks.

3. General Corporate Purpose

Our management, in accordance with the policies of our Board, will have flexibility in utilizing the proceeds earmarked for general corporate purposes. We intend to deploy the balance Fresh Issue proceeds aggregating Rs.725.51 Lakhs towards the general corporate purposes to drive our business growth. In accordance with the policies set up by our Board, we have flexibility in applying the remaining Net Proceeds, for general corporate purpose including but not restricted to, meeting operating expenses, initial development costs for projects other than the identified projects, and the strengthening of our business development and marketing capabilities, meeting exigencies, which the Company in the ordinary course of business may not foresee or any other purposes as approved by our Board of Directors, subject to compliance with the necessary provisions of the Companies Act, 2013.

We confirm that any issue related expenses shall not be considered as a part of General Corporate Purpose. Further, we confirm that the amount for general corporate purposes, as mentioned in the Prospectus, shall not exceed 25.00% of the amount raised by our Company through this Issue.

Public Issue Expenses

The total expenses for this Issue are estimated to be approximately Rs. 313.94 Lakhs, which is 10.38% of the Issue Size. All the Issue related expenses shall be proportionately met out from proceeds of the Issue as per applicable laws. The break-up of the same is as follows:

Particulars	Estimated expenses (Rs. in Lakhs)*	As a % of total estimated Issue related expenses	As a % of the total Issue Size
Book Running Lead Manger fees	25.00	7.96	0.83
Fees Payable to Registrar to the Issue	3.00	0.96	0.10
Fees Payable for Advertising and Publishing Expenses	12.00	3.82	0.40
Fees Payable to Regulators including Stock Exchanges	12.00	3.82	0.40
Payment for Printing & Stationery, Postage, etc.	1.00	0.32	0.03
Fees Payable to Auditor, Legal Advisors and other Professionals	2.00	0.64	0.07

Others, if any (Fees payable for Marketing & distribution expenses, Sponsor Bank/Banker(s) to the Issue, Selling Commission, Brokerage, depositories, secretarial, advisors, consultancy, peer review auditors, Processing Fees, Underwriting fees and Miscellaneous Expenses)	258.94	82.48	8.56
Total Estimated Issue Expenses	313.94	100.00	10.38

(1) Issue expenses excludes applicable taxes, where applicable. Issue expenses are estimates and are subject to change.

(2) Selling commission payable to the SCSBs on the portion for Retail Individual Bidders. Non-Institutional Bidders, which are directly procured by the SCSBs, would be as follows

Portion for Retail Individual Bidders*	0.10 % of the Amount Allotted* (plus applicable taxes)
Portion for Non-Institutional Bidders*	0.10 % of the Amount Allotted* (plus applicable taxes)

*Amount allotted is the product of the number of Equity Shares Allotted and the Issue Price. The selling commission payable to the SCSBs will be determined on the basis of the bidding terminal ID as captured in the Bid Book of BSE or NSE

(3) No uploading/ processing fees shall be payable by our Company to the SCSBs on the applications directly procured by them. Processing fees payable to the SCSBs on the portion for Retail Individual Bidders and Non-Institutional Bidders which are procured by the members of the Syndicate/ sub-Syndicate/ Registered Broker/ CRTAs/ CDPs and submitted to SCSB for blocking, would be as follows:

Portion for Retail Individual Bidders	Rs. 10/- per valid Bid cum Application Form (plus applicable taxes)
Portion for Non-Institutional Bidders	Rs. 10/- per valid Bid cum Application Form (plus applicable taxes)

Notwithstanding anything contained above the total processing fee payable under this clause will not exceed Rs.1 Lakh (plus applicable taxes) and in case if the total processing fees exceeds Rs.1 Lakh (plus applicable taxes) then processing fees will be paid on pro-rata basis.

(4) The processing fees for applications made by Retail Individual Bidders using the UPI Mechanism would be as follows:

Members of the Syndicate/ RTAs/ CDPs (uploading charges)	Rs. 10/- per valid application (plus applicable taxes)
Sponsor Bank – HDFC Bank Limited	Rs. 6/- per valid Bid cum Application Form* (plus applicable taxes) The Sponsor Bank shall be responsible for making payments to the third parties such as remitter bank, NPCI and such other parties as required in connection with the performance of its duties under the SEBI circulars, the Syndicate Agreement and other applicable laws.

*For each valid application by respective Sponsor Bank

Notwithstanding anything contained above in this clause the total Uploading charges/ Processing fees payable to Members of the Syndicate/ RTAs/ CDPs for applications made by RIBs (up to ₹200,000), Non-Institutional Bidders (for an amount more than ₹200,000 and up to ₹500,000) using the UPI Mechanism and in case if the total uploading charges/ processing fees exceeds Rs. 1 Lakh (plus applicable taxes) then uploading charges/ processing fees using UPI Mechanism will be paid on pro-rata basis.

(5) Selling commission on the portion for Retail Individual Bidders and Non-Institutional Bidders which are procured by members of the Syndicate (including their sub-Syndicate Members), Registered Brokers, CRTAs and CDPs or for using 3-in-1 type accounts-linked online trading, demat & bank account provided by some of the Registered Brokers which are Members of the Syndicate (including their Sub-Syndicate Members) would be as follows:

Portion for Retail Individual Bidders	0.10 % of the Amount Allotted* (plus applicable taxes)
Portion for Non-Institutional Bidders	0.10 % of the Amount Allotted* (plus applicable taxes)

*Amount Allotted is the product of the number of Equity Shares Allotted and the Issue Price

Uploading charges payable to Members of the Syndicate (including their sub-Syndicate Members), CRTAs and CDPs on the applications made by RIBs using 3-in-1 accounts and Non-Institutional Bidders which are procured by them and submitted to SCSB for blocking or using 3-in-1 accounts, would be as follows: Rs. 10/- plus applicable taxes, per valid application bid by the Syndicate (including their sub-Syndicate Members), CRTAs and CDPs.

Bidding charges payable to the Registered Brokers, CRTAs/ CDPs on the portion for RIBs and Non-Institutional Bidders which are directly procured by the Registered Brokers or CRTAs or CDPs and submitted to SCSB for processing would be as follows:

Portion for Retail Individual Bidders*	Rs. 10/- per valid application (plus applicable taxes)
Portion for Non-Institutional Bidders*	Rs. 10/- per valid application (plus applicable taxes)

* Based on valid applications

Notwithstanding anything contained above the total uploading/ bidding charges payable under this clause will not exceed Rs. 1 Lakh (plus applicable taxes) and in case if the total uploading/ bidding charges exceeds Rs. 1 Lakh (plus applicable taxes) then uploading charges will be paid on pro-rata basis.

The Selling Commission payable to the Syndicate/ Sub-Syndicate Members will be determined on the basis of the Bid cum Application Form number/ series, provided that the application is also bid by the respective Syndicate/ Sub-Syndicate Member. For clarification, if a Syndicate ASBA application on the Bid cum Application Form number/ series of a Syndicate/ Sub-Syndicate Member, is bid by an SCSB, the Selling Commission will be payable to the SCSB and not the Syndicate/ Sub-Syndicate Member. Bidding Charges payable to members of the Syndicate (including their sub-Syndicate Members), CRTAs and CDPs on the portion for RIBs and Non-Institutional Bidders which are procured by them and submitted to SCSB for blocking, would be as follows: Rs.10/- plus applicable taxes, per valid application bid by the Syndicate (including their sub-Syndicate Members), CRTAs and CDPs.

The selling commission and bidding charges payable to Registered Brokers the CRTAs and CDPs will be determined on the basis of the bidding terminal ID as captured in the Bid Book of BSE or NSE

All such commissions and processing fees set out above shall be paid as per the timelines in terms of the Syndicate Agreement and/or Escrow and Sponsor Bank Agreement. Further, the processing fees for applications made by UPI Bidders using the UPI Mechanism may be released to the remitter banks (SCSBs) only after such banks provide a written confirmation on compliance with SEBI Circular No: SEBI/HO/CFD/DIL2/P/CIR/2021/570 dated June 2, 2021 read with SEBI Circular No: SEBI/HO/CFD/DIL2/CIR/P/2021/2480/1/M dated March 16, 2021.

Proposed Schedule of Implementation:

The proposed year wise break up of deployment of funds and Schedule of Implementation of Net Issue Proceeds is as under:

		(₹ In Lakhs)
S. No.	Particulars	F.Y. 2024-25
1.	Funding of capital expenditure towards installation of new Plant & Machinery	404.55
2.	Repayment and/or pre-payment, in full or part, of certain borrowings availed by our Company;	1580.00
3.	General Corporate Purpose	725.51
	Total	2710.06

To the extent our Company is unable to utilize any portion of the Net Proceeds towards the Objects, as per the estimated schedule of deployment specified above, our Company shall deploy the Net Proceeds in the subsequent Financial Years towards the Objects.

Appraisal

None of the Objects have been appraised by any bank or financial institution or any other independent third-party organization. The funding requirements of our Company and the deployment of the proceeds of the Issue are currently based on available quotations and management estimates. The funding requirements of our Company are dependent on a number of factors which may not be in the control of our management, including but not limited to variations in interest rate structures, changes in our financial condition and current commercial conditions of our Business and are subject to change in light of changes in external circumstances or in our financial condition, business or strategy.

Shortfall of Funds

Any shortfall in meeting the fund requirements will be met by way of internal accruals and or unsecured Loans.

Bridge Financing Facilities

As on the date of this Prospectus, we have not entered into any bridge finance arrangements that will be repaid from the Net Proceeds. However, in case of delay in the IPO and consequent delay in accessing the net proceeds of the Issue, we may draw down such amounts, as may be required, from an overdraft arrangement / cash credit / term loan facility with our lenders or through unsecured loans to finance setting up of facilities as described in the section 'Objects of the Issue' until completion of the Issue. Any amount that is drawn down from such facility availed from any Bank/NBFC or Financial Institution or through unsecured loans during this period to finance 'Objects of the Issue' will be repaid from the Net Proceeds of the Issue.

Monitoring Utilization of Funds

As the size of the Issue will not exceed ₹10,000 Lakhs, the appointment of Monitoring Agency would not be required as per Regulation 262(1) of the SEBI ICDR Regulations. Our Board and the management will monitor the utilization of the Net Issue Proceeds through our audit committee. Pursuant to Regulation 32 of the SEBI Listing Regulations, our Company shall on half-yearly basis disclose to the Audit Committee the Application of the proceeds of the Issue. On an annual basis, our Company shall prepare a statement of funds utilized for purposes other than stated in this Prospectus and place it before the Audit Committee. Such disclosures shall be made only until such time that all the proceeds of the Issue have been utilized in full.

Interim Use of Proceeds

Pending utilization of the Issue proceeds of the Issue for the purposes described above, our Company will deposit the Net Proceeds with scheduled commercial banks included in schedule II of the RBI Act.

Our Company confirms that it shall not use the Net Proceeds for buying, trading or otherwise dealing in shares of any listed company or for any investment in the equity markets or investing in any real estate product or real estate linked products.

Variation in Objects

In accordance with Section 27 of the Companies Act, 2013, our Company shall not vary the objects of the Issue without our Company being authorized to do so by the Shareholders by way of a special resolution. In addition, the notice issued to the Shareholders in relation to the passing of such special resolution shall specify the prescribed details as required under the Companies Act and shall be published in accordance with the Companies Act and the rules there under. As per the current provisions of the Companies Act, our Promoters or controlling Shareholders would be required to provide an exit opportunity to such shareholders who do not agree to the proposal to vary the objects, at such price, and in such manner, as may be prescribed by SEBI, in this regard.

Other confirmations

There are no material existing or anticipated transactions with our Promoters, our Directors and our Company's key Managerial personnel, in relation to the utilization of the Net Proceeds.

BASIS FOR ISSUE PRICE

Investors should read the following summary with the section titled “**Risk Factors**”, the details about our Company under the section titled “**Our Business**” and its financial statements under the section titled “**Financial Information of the Company**” beginning on page 25, 98 and 144 respectively of the Prospectus. The trading price of the Equity Shares of Our Company could decline due to these risks and the investor may lose all or part of his investment.

Issue Price has been determined by our Company in consultation with the Book Running Lead Manager on the basis of the assessment of market demand for the Equity Shares through the Book Building Process and on the basis of the qualitative and quantitative factors as described in this section. The face value of the Equity Shares is ₹10/- each and the Issue Price is 10.0 times of the face value at the lower end of the Price Band and 10.5 times of the face value at the upper end of the Price Band.

QUALITATIVE FACTORS

We believe the following business strengths allow us to successfully compete in the industry:

- a) Strong portfolio and diverse range of copper products
- b) Stringent quality control mechanism ensuring standardized product quality
- c) Revenue from multiple geographies in India
- d) Experienced Senior Management

For a detailed discussion on the qualitative factors which form the basis for computing the price, please refer to sections titled “**Our Business**” beginning on page 98 of this Prospectus.

QUANTITATIVE FACTORS

The information presented below relating to our Company is based on the Restated Financial Statements. For details, please refer section titled “**Financial Information of the Company**” on page 144 of this Prospectus.

Some of the quantitative factors which may form the basis for calculating the Issue Price are as follows:

(i) Basic & Diluted Earnings per share (EPS) (Face value of ₹10 each):

As per the Restated Financial Statements: -

Sr. No	F.Y./Period	Basic & Diluted (₹)	Weights
1.	Financial Year ending March 31, 2024	19.35	3
2.	Financial Year ending March 31, 2023	14.01	2
3.	Financial Year ending March 31, 2022	10.65	1
	Weighted Average	16.12	6

Notes:

- i. The figures disclosed above are based on the Restated Financial Statements of the Company.
- ii. The face value of each Equity Share is ₹10.00.
- iii. Earnings per Share has been calculated in accordance with **Accounting Standard 20 – “Earnings per Share”** issued by the Institute of Chartered Accountants of India.
- iv. The above statement should be read with **Significant Accounting Policies and the Notes to the Restated Financial Statements as appearing in Annexure IV.**
- v. **Basic Earnings per Share = Net Profit/(Loss) after tax, as restated attributable to equity shareholders / Weighted average number of equity shares outstanding during the year/ period**
- vi. **Diluted Earnings per Share = Net Profit/(Loss) after tax, as restated attributable to equity shareholders / Weighted average number of diluted potential equity shares outstanding during the year/ period.**

(ii) Price Earning (P/E) Ratio in relation to the Price Band of ₹100 to ₹105 per Equity Share of Face Value of ₹10/- each fully paid up:

Particulars	(P/E) Ratio at the Floor Price (₹ 100)	(P/E) Ratio at the Cap Price (₹ 105)
P/E ratio based on the Basic & Diluted EPS, as restated for period ending March 31, 2024	5.17	5.43
P/E ratio based on the Weighted Average EPS, as restated.	6.20	6.51

Industry P/E Ratio*	(P/E) Ratio
Industry Highest (Rajnandini Metal Limited)	24.71
Industry Lowest (Bhagyanagar India Limited)	7.67
Industry Average	16.19

* For the purpose of industry, we have considered those companies which are engaged in the similar line of business segment as of our Company, however, they may not be exactly comparable in terms of product portfolio or the size of our Company. The peers have been included for the purpose of broad comparison.

Note:

- The P/E ratio of our Company has been computed by dividing Issue Price with EPS.
- P/E Ratio of the peer company is based on the Audited Results for the F.Y. 2023-24 and stock exchange data dated August 01, 2024

(iii) Return on Net worth (RoNW)

Sr. No	Period	RoNW (%)	Weights
1.	Period ending March 31, 2024	44.43%	3
2.	Period ending March 31, 2023	154.74%	2
3.	Period ending March 31, 2022	36.77%	1
	Weighted Average	79.92%	6

Note:

- The figures disclosed above are based on the Restated Financial Statements of the Company.
- The RoNW has been computed by dividing restated net profit after tax (excluding exceptional items) with restated Net worth as at the end of the year/period
- Weighted average = Aggregate of year-wise weighted RoNW divided by the aggregate of weights i.e. (RoNW x Weight) for each year/Total of weights.

(iv) Net Asset Value (NAV) per Equity Share:

Sr. No.	NAV per Equity Share	(Amount in ₹)
1.	As at March 31, 2022	28.96
2.	As at March 31, 2023	9.05
3.	As at March 31, 2024	43.55
4.	NAV per Equity Share after the Issue	
	a) at Floor Price	44.89
	b) at Cap Price	46.21
5.	Issue Price	105.00

*The above NAV has been calculated based on weighted number of shares outstanding at the end of the respective year.

Notes:

- The figures disclosed above are based on the Restated Financial Statements of the Company.
- NAV per share=Restated Net worth at the end of the year/period divided by weighted average number of equity shares outstanding at the end of the year/period
- Net worth is computed as the sum of the aggregate of paid-up equity share capital, all reserves created out of the profits, securities premium account received in respect of equity shares and debit or credit balance of profit and loss account.
- Issue Price per Equity Share will be determined by our Company in consultation with the Book Running Lead Manager.

(v) Comparison of Accounting Ratios with Industry Peers

Name of Company	Current Market Price (₹)	Face Value	EPS	PE	RoNW (%)	Book Value (₹)	Total Income (₹ In lakhs)
			Basic/Diluted				
Sunlite Recycling Industries Limited	105	10	19.35	5.43	44.43%	43.55	1,16,655.09
Peer Group							
Rajnandini Metal Limited	13.59	10	0.55	24.71	26.94%	2.05	1,22,093.00
Bhagyanagar India Limited	109.60	2	14.29	7.67	23.65%	60.44	1,47,480.35

Notes:

- Source – All the financial information for listed industry peers mentioned above is sourced from the Annual Reports of the aforesaid companies for the year ended March 31, 2024 and stock exchange data dated August 01, 2024 to compute the

corresponding financial ratios. For our Company, we have taken Current Market Price as the issue price of equity share. Further, P/E Ratio is based on the current market price of the respective scrips.

- (ii) The EPS, NAV, RoNW and total Income of our Company are taken as per Restated Financial Statement for the Financial Year 2023-24.
- (iii) NAV per share is computed as the closing net worth divided by the weighted average number of paid up equity shares as on March 31, 2024.
- (iv) RoNW has been computed as net profit after tax divided by closing net worth.
- (v) Net worth has been computed in the manner as specifies in Regulation 2(1) (hh) of SEBI (ICDR) Regulations, 2018.
- (vi) The face value of Equity Shares of our Company is ₹10/- per Equity Share and the Issue price is 105 times the face value of equity share.

(vi) Key Performance Indicators

The KPIs disclosed below have been used historically by our Company to understand and analyze the business performance, which in result, help us in analyzing the growth of our company.

The KPIs disclosed below have been approved by a resolution of our Audit Committee dated July 20, 2024 and the members of the Audit Committee have verified the details of all KPIs pertaining to our Company. Further, the members of the Audit Committee have confirmed that there are no KPIs pertaining to our Company that have been disclosed to any investors at any point of time during the three years' period prior to the date of filing of this Prospectus. Further, the KPIs herein have been certified by M/s Abhishek Kumar & Associates, Chartered Accountants, by their certificate dated July 20, 2024 .

The KPIs of our Company have been disclosed in the sections titled “*Our Business*” and “*Management’s Discussion and Analysis of Financial Condition and Results of Operations – Key Performance Indicators*” on pages 98 and 185, respectively. We have described and defined the KPIs as applicable in “*Definitions and Abbreviations*” on page 1 of this Prospectus.

Our Company confirms that it shall continue to disclose all the KPIs included in this section on a periodic basis, at least once in a year (or any lesser period as determined by the Board of our Company), for a duration of one year after the date of listing of the Equity Shares on the Stock Exchange or till the complete utilization of the proceeds of the Fresh Issue as per the disclosure made in the Objects of the Issue, whichever is later or for such other duration as may be required under the SEBI ICDR Regulations. Further, the ongoing KPIs will continue to be certified by a member of an expert body as required under the SEBI ICDR Regulations.

Key Performance Indicators of our Company

(₹In Lakhs except percentages and ratios)

Key Financial Performance	For the Year ended		
	March 31, 2024	March 31, 2023	March 31, 2022
Revenue from operations ⁽¹⁾	1,16,627.09	1,15,018.88	93,719.32
EBITDA ⁽²⁾	1,836.07	1,422.88	990.75
EBITDA Margin ⁽³⁾	1.57%	1.24%	1.06%
PAT ⁽⁴⁾	890.36	560.27	426.03
PAT Margin ⁽⁵⁾	0.76%	0.49%	0.45%
RoE(%) ⁽⁶⁾	75.26%	73.69%	47.85%
RoCE (%) ⁽⁷⁾	29.49%	24.05%	22.85%
Net Worth ⁽⁸⁾	2,003.90	362.08	1,158.58

Notes:

⁽¹⁾Revenue from operation means revenue from sales, service and other operating revenues

⁽²⁾EBITDA is calculated as Profit before tax + Depreciation + Interest Expenses - Other Income

⁽³⁾‘EBITDA Margin’ is calculated as EBITDA divided by Revenue from Operations

⁽⁴⁾ PAT is calculated as Profit before tax – Tax Expenses

⁽⁵⁾‘PAT Margin’ is calculated as PAT for the year divided by revenue from operations.

⁽⁶⁾ Return on Equity is ratio of Profit after Tax and Average Shareholder Equity

⁽⁷⁾ Return on Capital Employed is calculated as EBIT divided by capital employed, which is defined as shareholders’ equity plus total borrowings {current & non-current}.

⁽⁸⁾Net Worth = Equity Share Capital + Reserve and Surplus (including surplus in the Statement of Profit & Loss) - Preliminary Expenses to the extent not written-off.

Explanation for KPI metrics:

KPI	Explanations
Revenue from Operations	Revenue from Operations is used by our management to track the revenue profile of the business and in turn helps to assess the overall financial performance of our Company and volume of our business
EBITDA	EBITDA provides information regarding the operational efficiency of the business
EBITDA Margin (%)	EBITDA Margin (%) is an indicator of the operational profitability and financial performance of our business
PAT	Profit after tax provides information regarding the overall profitability of the business.
PAT Margin (%)	PAT Margin (%) is an indicator of the overall profitability and financial performance of our business.
RoE(%)	RoE provides how efficiently our Company generates profits from shareholders' funds.
RoCE (%)	RoCE provides how efficiently our Company generates earnings from the capital employed in the business.
Net Worth	Net worth is used by the management to ascertain the total value created by the entity and provides a snapshot of current financial position of the entity.

(vii) Set forth below are the details of comparison of key performance of indicators with our listed industry peer:

(₹In Lakhs except percentages and ratios)

Key Financial Performance	Sunlite Recycling Industries Ltd			Bhagyanagar India Limited			Rajnandini Metal Limited		
	FY 2023-24	FY 2022-23	FY 2021-22	FY 2023-24	FY 2022-23	FY 2021-22	FY 2023-24	FY 2022-23	FY 2021-22
Revenue from operations ⁽¹⁾	1,16,627.09	1,15,018.88	93,719.32	1,43,072.44	1,84,659.07	1,57,363.46	1,21,243.00	1,02,888.00	1,02,825.00
EBITDA ⁽²⁾	1,836.07	1,422.88	990.75	3,183.61	3,067.05	2,939.60	2,147.00	1,942.00	1,801.00
EBITDA Margin (%) ⁽³⁾	1.57%	1.24%	1.06%	2.23%	1.66%	1.87%	1.77%	1.89%	1.75%
PAT ⁽⁴⁾	890.36	560.27	426.03	4,572.37	1,013.04	1,108.18	1,524.00	1,368.00	1,002.00
PAT Margin (%) ⁽⁵⁾	0.76%	0.49%	0.45%	3.20%	0.55%	0.70%	1.26%	1.33%	0.97%
RoE(%) ⁽⁶⁾	75.26%	73.69%	47.85%	26.82%	7.11%	8.40%	31.06%	38.52%	40.76%
RoCE (%) ⁽⁷⁾	29.49%	24.05%	22.85%	23.56%	6.98%	8.70%	18.30%	25.05%	22.37%

Notes:

⁽¹⁾Revenue from operation means revenue from sales, service and other operating revenues

⁽²⁾EBITDA is calculated as Profit before tax + Depreciation + Interest Expenses - Other Income

⁽³⁾'EBITDA Margin' is calculated as EBITDA divided by Revenue from Operations

⁽⁴⁾ PAT is calculated as Profit before tax – Tax Expenses

⁽⁵⁾'PAT Margin' is calculated as PAT for the year divided by revenue from operations.

⁽⁶⁾ Return on Equity is ratio of Profit after Tax and Average Shareholder Equity

⁽⁷⁾ Return on Capital Employed is calculated as EBIT divided by capital employed, which is defined as shareholders' equity plus total borrowings (current & non-current).

(viii) Weighted average cost of acquisition**a) The price per share of our Company based on the primary/ new issue of shares (equity/ convertible securities)**

There has been no issuance of Equity Shares other than Equity Shares issued pursuant to a right issue on February 06, 2024 (except bonus), during the 18 months preceding the date of this Prospectus, where such issuance is equal to or more than 5% of the fully diluted paid-up share capital of the Company (calculated based on the pre-issue capital before such transaction(s) and excluding employee stock options granted but not vested), in a single transaction or multiple transactions combined together over a span of 30 days.

Date of Allotment	No. of equity Shares allotted	Face value (₹)	Issue Price (including Premium if applicable)(₹)	Nature of Consideration	Nature of Allotment	Amount of consideration (Rs. in lakhs)
February 06, 2024	40,00,000	10	11.79	Cash	Right Issue	471.60

b) The price per share of our Company based on the secondary sale/ acquisition of shares (equity shares)

There have been no secondary sale/ acquisitions of Equity Shares, where the promoters, members of the promoter group or shareholder(s) having the right to nominate director(s) in the board of directors of the Company are a party to the transaction (excluding gifts of shares), during the 18 months preceding the date of this certificate, where either acquisition or sale is equal to or more than 5% of the fully diluted paid up share capital of the Company (calculated based on the pre-issue capital before such transaction/s and excluding employee stock options granted but not vested), in a single transaction or multiple transactions combined together over a span of rolling 30 days.

Weighted average cost of acquisition & Issue price

Types of transactions	Weighted average cost of acquisition (₹ per Equity Shares)	Floor price* (i.e. ₹ 100)	Cap price* (i.e. ₹ 105)
Weighted average cost of acquisition of primary/ new issue as per paragraph 8(a) above.	11.79	8.48 times	8.91 times
Weighted average cost of acquisition for secondary sale/ acquisition as per paragraph 8(b) above.	NA [^]	NA [^]	NA [^]

Note:

[^]There were no secondary sales / acquisition of shares of shares (equity/ convertible securities) other than Shares transfer on in last 18 months from the date of this Prospectus.

* To be updated at Prospectus stage.

This is a Book Built Issue and the price band for the same shall be published 2 working days before opening of the Issue in all editions of the English national newspaper Business Standard, all editions of Hindi national newspaper Business Standard and Gujarati edition of Regional newspaper Ahmedabad Express where the registered office of the company is situated each with wide circulation.

The Price Band/ Floor Price/ Issue Price shall be determined by our Company in consultation with the BRLM and will be justified by us in consultation with the BRLM on the basis of the above information. Investors should read the above mentioned information along with “**Our Business**”, “**Risk Factors**” and “**Restated Financial Statements**” on pages 98, 25 and 144 respectively, to have a more informed view. The trading price of the Equity Shares of our Company could decline due to the factors mentioned in “**Risk Factors**” or any other factors that may arise in the future and you may lose all or part of your investments.

STATEMENT OF SPECIAL TAX BENEFITS

To,
The Board of Directors,
Sunlite Recycling Industries Limited
Survey No. 270A & Plot No.1, Survey No. 267, Chhatha Mile, Dantali, Vaso, Kheda -387350, Gujarat, India.

Re: Statement of Special Tax Benefits (“The Statement”) available to Sunlite Recycling Industries Limited (the “Company”) pursuant to Securities and Exchange Board of India (Issue of Capital and Disclosure Requirements) Regulations, 2018 (“SEBI ICDR Regulations”) and the Companies Act, 2013, as amended (the “Act”).

Dear Sirs/ Madam,

We hereby report that the enclosed annexure prepared by the management of Sunlite Recycling Industries Limited, states the special tax benefits available to the Company and the shareholders of the Company under the Income-Tax Act, 1961, the Central Goods and Services Tax Act, 2017, the Integrated Goods and Services Tax Act, 2017, the Union Territory Goods and Services Tax Act, 2017, respective State Goods and Services Tax Act, 2017 (collectively the “GST Act”) presently in force in India. Several of these benefits are dependent on the Company or its shareholders fulfilling the conditions prescribed under the relevant provisions of the Act. Hence, the ability of the Company or its shareholders to derive the tax benefits is dependent upon fulfilling such conditions which, based on business imperatives which the Company may face in the future, the Company may or may not choose to fulfill.

The benefits discussed in the enclosed Annexure cover only special tax benefits available to the Company and do not cover any general tax benefits available to the Company. Further, the preparation of enclosed statement and the contents stated therein is the responsibility of the Company’s management. We are informed that, this Statement is only intended to provide general information to the investors and is neither designed nor intended to be a substitute for professional tax advice. In view of the individual nature of the tax consequences and the changing tax laws, each investor is advised to consult his or her own tax consultant with respect to the specific tax implications arising out of their participation in the proposed initial public offering of Equity shares (“the Issue”) by the Company.

We do not express any opinion or provide any assurance as to whether:

- a) The Company or its shareholders will continue to obtain these benefits in future; or
- b) The conditions prescribed for availing the benefits have been/would be met.

The contents of the enclosed statement are based on information, explanations and representations obtained from the Company and on the basis of our understanding of the business activities and operations of the Company.

Limitations:

Our views are based on facts and assumptions indicated to us and the existing provisions of tax law and its interpretations, which are subject to change or modification from time to time by subsequent legislative, regulatory, administrative, or judicial decisions. Any such changes, which could also be retrospective, could have an effect on the validity of our views stated herein.

We assume no obligation to update this statement on any events subsequent to its issue, which may have a material effect on the discussions herein. This report including enclosed annexure are intended solely for your information and for the inclusion in the Draft Offer Document/ Offer Document or any other issue related material in connection with the proposed initial public offer of the Company and is not to be used, referred to or distributed for any other purpose without our prior written consent.

This statement has been prepared solely in connection with the Proposed Issue by the Company under the Securities and Exchange Board of India (Issue of Capital and Disclosure Requirements) Regulations, 2018, as amended.

For, M/s. Abhishek Kumar & Associates
Chartered Accountants,
FRN: 130052W

Sd/-
CA Abhishek Kumar Agarwal
Proprietor
M. No. 132305
Place: Ahmedabad
Date: May 08, 2024
UDIN: 24132305BKEYVJ1612

ANNEXURE TO THE STATEMENT OF SPECIAL TAX BENEFITS

The information provided below sets out the special tax benefits available to the Company and the Equity Shareholders under the Income Tax Act, 1961 presently in force in India. It is not exhaustive or comprehensive and is not intended to be a substitute for professional advice. Investors are advised to consult their own tax consultant with respect to the tax implications of an investment in Equity Shares particularly in view of the fact that certain recently enacted legislation may not have a direct legal precedent or may have a different interpretation on the benefits, which an investor can avail.

A. SPECIAL DIRECT AND INDIRECT TAX BENEFITS TO THE COMPANY:

The Company is not entitled to any special tax benefits under the Income Tax Act, 1961 and GST Act.

B. SPECIAL DIRECT AND INDIRECT TAX BENEFITS TO THE SHAREHOLDERS:

The Shareholders of the Company are not entitled to any special tax benefits under the Income Tax Act, 1961 and GST Act.

NOTES:

1. The above Annexure of special tax benefits sets out the provisions of Tax Laws in a summary manner only and is not a complete analysis or listing of all potential tax consequences of the purchase, ownership and disposal of shares.
2. The above Annexure covers only the special tax benefits under the Act, read with the relevant rules, circulars and notifications and does not cover any benefit under any other law in force in India. This Annexure also does not discuss any tax consequences, in the country outside India, of an investment in the shares of an Indian company.
3. The above Annexure of special tax benefits is as per the current direct tax laws relevant for the assessment year 2023-24. Several of these benefits are dependent on the Company or its shareholders fulfilling the conditions prescribed under the relevant provisions of the Tax Laws.
4. In respect of non-residents, the tax rates and consequent taxation mentioned above will be further subject to any benefits available under the relevant Double Taxation Avoidance Agreement, if any, entered into between India and the country in which the non-resident has fiscal domicile.
5. A new Section 115BAA has been inserted by the Taxation Laws (Amendment) Act, 2019 ('the Amendment Act, 2019') with effect from Financial Year 2019-20 granting an option to domestic companies to compute corporate tax at a reduced rate of 25.168% (22% plus surcharge of 10% and cess of 4%), provided such companies do not avail specified exemptions/ incentives. The option under section 115BAA of the Act once exercised cannot be subsequently withdrawn for any future financial year. The Amendment Act, 2019 further provides that domestic companies availing such option will not be required to pay Minimum Alternate Tax ('MAT') under Section 115JB. The CBDT has further issued Circular 29/2019 dated October 02, 2019 clarifying that since the MAT provisions under Section 115JB itself would not apply where a domestic company exercises option of lower tax rate under Section 115BAA, MAT credit would not be available.

In such a case, the Company is not allowed to claim any of the following deductions/ exemptions under the Act: -

- ✓ Deduction under the provisions of Section 10AA.
- ✓ Deduction under clause (iia) of sub-section (1) of Section 32 (additional depreciation).
- ✓ Deduction under section 32AD or Section 33AB or Section 33ABA
- ✓ Deduction under section 35AD or Section 35CCC
- ✓ Deduction under section 80G

Lower corporate tax rate under Section 115BAA of the Act and Minimum Alternate Tax ('MAT') credit under section 115JAA of the Act which are in general available and hence may not be treated as special tax benefits.

The Company has evaluated and decided to exercise the option permitted under Section 115BAA of the Act for the purpose of computing its income-tax liability for the Financial Year 2022-23 and onwards.

6. This Annexure is intended only to provide general information to the investors and is neither designed nor intended to be a substitute for professional tax advice. In view of the individual nature of tax consequences, each investor is advised to consult his or her tax advisor with respect to specific tax consequences of his/her investment in the shares of the Company.
7. No assurance is given that the revenue authorities/ courts will concur with the views expressed herein. The views are based on the existing provisions of law and its interpretation, which are subject to changes from time to time. We do not assume responsibility to update the views consequent to such changes. We shall not be liable to any claims, liabilities or expenses

relating to this assignment except to the extent of fees relating to this assignment, as finally judicially determined to have resulted primarily from bad faith or intentional misconduct. We will not be liable to any other person in respect of this statement.

For, M/s. Abhishek Kumar & Associates
Chartered Accountants,
FRN: 130052W

Sd/-

CA Abhishek Kumar Agarwal
Proprietor
M. No. 132305
Place: Ahmedabad
Date: May 08, 2024
UDIN: 24132305BKEYVJ1612

SECTION V – ABOUT THE COMPANY

INDUSTRY OVERVIEW

The information in this section has been extracted from various websites and publicly available documents from various industry sources. The data may have been re-classified by us for the purpose of presentation. Neither we nor any other person connected with the issue has independently verified the information provided in this section.

WORLD ECONOMIC OUTLOOK

Global growth is projected at 3.1 percent in 2024 and 3.2 percent in 2025, with the 2024 forecast 0.2 percentage point higher than that in the October 2023 World Economic Outlook (WEO) on account of greater-than-expected resilience in the United States and several large emerging market and developing economies, as well as fiscal support in China. The forecast for 2024–25 is, however, below the historical (2000–19) average of 3.8 percent, with elevated central bank policy rates to fight inflation, a withdrawal of fiscal support amid high debt weighing on economic activity, and low underlying productivity growth.

Inflation is falling faster than expected in most regions, in the midst of unwinding supply-side issues and restrictive monetary policy. Global headline inflation is expected to fall to 5.8 percent in 2024 and to 4.4 percent in 2025, with the 2025 forecast revised down.

With disinflation and steady growth, the likelihood of a hard landing has receded, and risks to global growth are broadly balanced. On the upside, faster disinflation could lead to further easing of financial conditions. Looser fiscal policy than necessary and then assumed in the projections could imply temporarily higher growth, but at the risk of a more costly adjustment later on.

Stronger structural reform momentum could bolster productivity with positive cross-border spillovers. On the downside, new commodity price spikes from geopolitical shocks—including continued attacks in the Red Sea—and supply disruptions or more persistent underlying inflation could prolong tight monetary conditions. Deepening property sector woes in China or, elsewhere, a disruptive turn to tax hikes and spending cuts could also cause growth disappointments.

Policymakers' near-term challenge is to successfully manage the final descent of inflation to target, calibrating monetary policy in response to underlying inflation dynamics and—where wage and price pressures are clearly dissipating—adjusting to a less restrictive stance. At the same time, in many cases, with inflation declining and economies better able to absorb effects of fiscal tightening, a renewed focus on fiscal consolidation to rebuild budgetary capacity to deal with future shocks, raise revenue for new spending priorities, and curb the rise of public debt is needed.

Targeted and carefully sequenced structural reforms would reinforce productivity growth and debt sustainability and accelerate convergence toward higher income levels. More efficient multilateral coordination is needed for, among other things, debt resolution, to avoid debt distress and create space for necessary investments, as well as to mitigate the effects of climate change.

The global economic recovery from the COVID-19 pandemic, Russia's invasion of Ukraine, and the cost-of-living crisis is proving surprisingly resilient. Inflation is falling faster than expected from its 2022 peak, with a smaller-than-expected toll on employment and activity, reflecting favorable supply-side developments and tightening by central banks, which has kept inflation expectations anchored. At the same time, high interest rates aimed at fighting inflation and a withdrawal of fiscal support amid high debt are expected to weigh on growth in 2024.

Growth resilient in major economies. Economic growth is estimated to have been stronger than expected in the second half of 2023 in the United States, and several major emerging market and developing economies. In several cases, government and private spending contributed to the upswing, with real disposable income gains supporting consumption amid still-tight—though easing—labor markets and households drawing down on their accumulated pandemic-era savings. A supply-side expansion also took hold, with a broad-based increase in labor force participation, resolution of pandemic-era supply chain problems, and declining delivery times.

The rising momentum was not felt everywhere, with notably subdued growth in the euro area, reflecting weak consumer sentiment, the lingering effects of high energy prices, and weakness in interest-rate-sensitive manufacturing and business investment. Low-income economies continue to experience large output losses compared with their prepandemic (2017–19) paths amid elevated borrowing costs.

Inflation subsiding faster than expected. Amid favorable global supply developments, inflation has been falling faster than expected, with recent monthly readings near the prepandemic average for both headline and underlying (core) inflation (Figure 1). Global headline inflation in the fourth quarter of 2023 is estimated to have been about 0.3 percentage point lower than predicted in the October 2023 WEO on a quarter-over-quarter seasonally adjusted basis.

Diminished inflation reflects the fading of relative price shocks—notably those to energy prices—and their associated pass-through to core inflation.¹ The decline also reflects an easing in labor market tightness, with a decline in job vacancies, a modest rise in

unemployment, and greater labor supply, in some cases associated with a strong inflow of immigrants. Wage growth has generally remained contained, with wage-price spirals—in which prices and wages accelerate together—not taking hold. Near-term inflation expectations have fallen in major economies, with long-term expectations remaining anchored.

Figure 1. Global Inflation: Rise and Fall
(Month-over-month annualized percent change, seasonally adjusted)

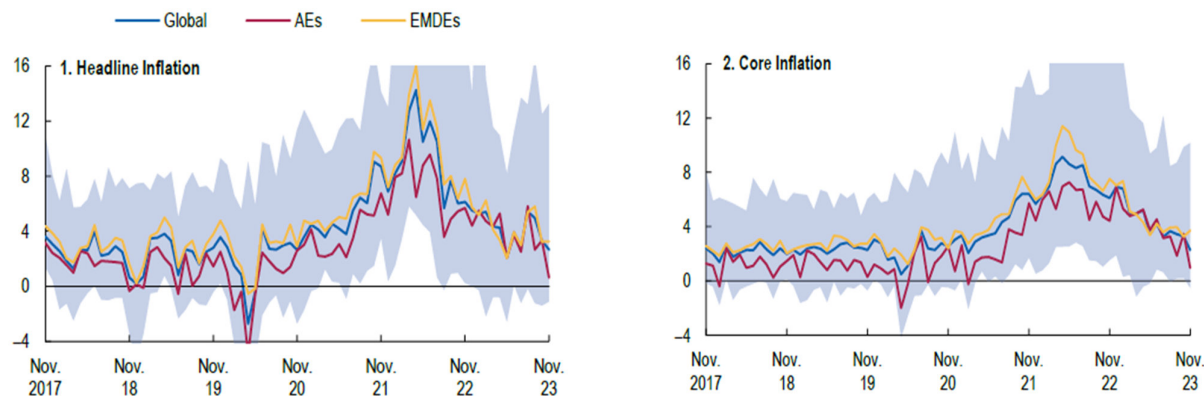

Sources: Haver Analytics; and IMF staff calculations.

Note: The figure plots the median of a sample of 57 economies that accounts for 78 percent of World Economic Outlook world GDP (in weighted purchasing-power-parity terms) in 2023. Vertical axes are cut off at -4 percent and 16 percent. The bands depict the 10th to 90th percentiles of inflation across economies. "Core inflation" is the percent change in the consumer price index for goods and services, excluding food and energy (or the closest available measure). AEs = advanced economies; EMDEs = emerging market and developing economies.

High borrowing costs cooling demand. To reduce inflation, major central banks raised policy interest rates to restrictive levels in 2023, resulting in high mortgage costs, challenges for firms refinancing their debt, tighter credit availability, and weaker business and residential investment. Commercial real estate has been especially under pressure, with higher borrowing costs compounding postpandemic structural changes. But with inflation easing, market expectations that future policy rates will decline have contributed to a reduction in longer-term interest rates and rising equity markets (Box 1). Still, long-term borrowing costs remain high in both advanced and emerging market and developing economies, partly because government debt has been rising.

In addition, central banks' policy rate decisions are becoming increasingly asynchronous. In some countries with falling inflation—including Brazil and Chile, where central banks tightened policy earlier than in other countries—interest rates have been declining since the second half of 2023. In China, where inflation has been near zero, the central bank has eased monetary policy. The Bank of Japan has kept short-term interest rates near zero.

Fiscal policy amplifying economic divergences. Governments in advanced economies eased fiscal policy in 2023. The United States, where GDP had already exceeded its prepandemic path, eased policy more than did euro area and other economies in which the recovery was incomplete. In emerging market and developing economies, in which output has on average fallen even further below the prepandemic trend, on average the fiscal stance is estimated to have been neutral.

The exceptions include Brazil and Russia, where fiscal policy eased in 2023. In low-income countries, liquidity squeezes and the elevated cost of interest payments—averaging 13 percent of general government revenues, about double the level 15 years ago—crowded out necessary investments, hampering the recovery of large output losses compared with prepandemic trends. In 2024, the fiscal policy stance is expected to tighten in several advanced and emerging market and developing economies to rebuild budgetary room for maneuver and curb the rising path of debt, and this shift is expected to slow growth in the near term.

Source: <https://www.imf.org/en/Publications/WEO/Issues/2024/01/30/world-economic-outlook-update-january-2024#:~:text=The%20forecast%20for%202024%E2%80%93325,and%20low%20underlying%20productivity%20growth.>

THE INDIAN ECONOMY: A REVIEW

It now appears very likely that the Indian economy will achieve a growth rate at or above 7% for FY24, and some predict it will achieve another year of 7% real growth in FY25 as well. If the prognosis for FY25 turns out to be right, that will mark the fourth year post-pandemic that the Indian economy will have grown at or over 7 per cent. That would be an impressive achievement, testifying to the resilience and potential of the Indian economy. It augurs well for the future.

Some economists argue, with considerable merit, that not all growth is equal. They are right. It is one thing for India to grow at 8-9 per cent when the world economy is growing at 4 per cent, but it is another thing to grow at or above 7 per cent when the world economy is struggling to grow at 2 per cent. One unit of growth in the latter circumstance is qualitatively superior to the former. The marginal utility of growth in the second scenario is much higher.

The global economy is struggling to maintain its recovery post-Covid because successive shocks have buffeted it. Some of them, such as supply chain disruptions, have returned in 2024. If they persist, they will impact trade flows, transportation costs, economic output and inflation worldwide. India will not be exempt from it, but having faced and seen off COVID and the energy and commodity price shocks of 2022, India is quietly confident of weathering the emerging disturbances.

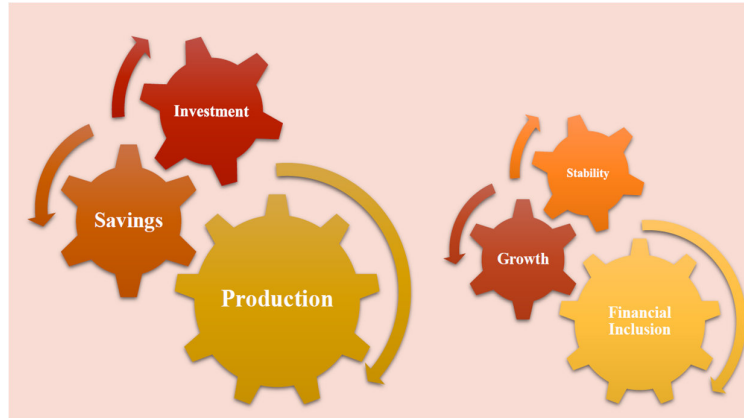

At least three trends will be with us in the coming years. The era of hyper-globalisation in global manufacturing is over. It does not mean that de-globalisation will be upon us any time soon, as countries are only now discovering the enormous integration of global supply chains that have taken place in the last few decades. So, an alternative to the globalisation of supply chains will take much longer to emerge if it ever does. However, that will not deter governments from pursuing onshoring and friend-shoring of production with a consequent impact on transportation, logistics costs, and, hence, the final prices of products.

Recent events in the Red Sea may have brought back concerns over reliance on global supply chains, further aggravating the slower growth in global trade in 2023. In other words, exporting one's way to growth will not be easy. This reinforces the need to lower logistics costs and invest in product quality to hold on to and expand market share in areas where India has an advantage.

Closely related to this challenge is the advent of Artificial Intelligence with the profound and troubling questions it poses for growth in services trade and employment since technology might remove the advantage of cost competitiveness that countries exporting digital services enjoy.

Third and arguably the most important is the energy transition challenge. Concerns over rising temperatures have led to a single-minded focus on reducing carbon emissions amidst the determination that the emission of greenhouse gases, particularly carbon, is the most significant causal factor. This has led to persistent demands from international organisations and advanced nations on developing nations to wean themselves off fossil fuels and switch to greener energy even as technological and resource obstacles remain and are not on offer from developed countries. It is a reality that, in the short run, there is a trade-off between economic growth and energy transition.

In a growth-challenged post-Covid global economy, countries can ill afford to sacrifice the former for the latter. India is walking the fine line between the two more skilfully than other nations, with installed non-fossil fuel-based power generation capacity running ahead of targets. Importantly, India's unwavering commitment to ensuring steady economic growth is generating resources for investment needed for climate change adaptation, building resilience, and mitigating emissions.

The Indian economy is better placed than ever to take on these three key challenges because of the policies adopted and implemented in the last decade. The Union government has built infrastructure at a historically unprecedented rate, and it has taken the overall public sector capital investment from ₹5.6 lakh crore in FY15 to ₹18.6 lakh crore in FY24, as per budget estimates. That is a rise of 3.3X. Whether the total length of highways, freight corridors, number of airports, metro rail networks or the trans-sea link, the ramp-up of physical and digital infrastructure in the last ten years is real, tangible and transformative.

The pursuit of inclusive development finds Indian households in good financial health. Fifty-one crore bank accounts under Jan Dhan Yojana now have total deposits of over ₹2.1 lakh crore. Over 55 per cent of them are women. In Dec. 2019, household financial assets were 86.2 per cent of GDP; liabilities were 33.4 per cent of GDP. In March 2023, these numbers were 103.1 per cent and

37.6 per cent, respectively. So, Net Financial Assets of households were 52.8 per cent of GDP in Dec. 2019, and by March 2023, it had improved to 65.5 per cent of GDP.

The economy has created jobs; the unemployment rate has declined considerably from the peaks during Covid times. The labour force participation rate has increased, especially that of women. Net new subscribers to the Employee Provident Fund (EPF) have steadily risen post-Covid, especially among the younger population. Women are also enrolling more than ever in tertiary education. The Eleventh Edition of the CII-Wheebox India Skills Report based on the National Employability Test conducted by Wheebox2 shows India’s youth employability at 51.3 per cent, up from 33 per cent a decade ago. Institutional births are widely prevalent, and the infant mortality rate has declined, as has stunting. More remains to be done, however.

Two things must be singled out here. The government’s COVID management and the vaccination record have been instrumental in the quick recovery staged by the economy. Similarly, the deft management of the crude oil supply at reasonable prices in the last two years is noteworthy. Humans are not capable of appreciating the unseen - the mistakes not made and the risks avoided - but the counterfactuals are all around us.

They cannot be missed. Today, many young Indians not only aspire to a better life but are also confident that it will happen in their lifetime. They feel that they have a better life than their previous generations and that succeeding generations will do better than them. Nations and people have to believe in themselves for important changes to happen. Now, India does, and Indians do.

Safeguarding Macroeconomic stability

Macroeconomic stability built on an economic environment with strong output growth, price stability, and robust external account are important goals of the government and the Reserve Bank of India. Considering the multiple challenges, the government of India has committed to an institutional architecture that fosters macro stability.

Reigning in inflation with flexible targeting: The period between FY09 and FY14 was marked by high average retail inflation of 10 per cent and high levels of macro-vulnerability. Since the advent of flexible inflation-targeting within the band of 4 +/- 2 per cent under the Monetary Policy Framework Agreement in FY16, retail inflation averaged 4.2 per cent till FY20. The Price Stabilization Fund (PSF) set up in 2014-15 has been effective in tackling price volatility in important agri-horticultural commodities. Concurrently, the fiscal balance of the general government and the country’s external balance improved, progressively reducing macro-vulnerabilities and generating buffers for turbulent times ahead.

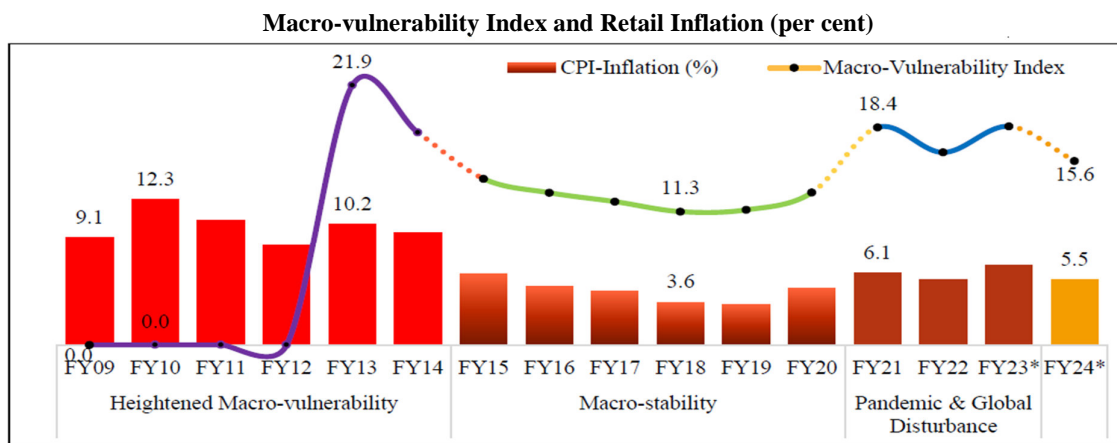

Note: Retail Inflation from FY09 to FY12 is based on CPI-Industrial Workers released by the Labour Bureau, FY13 to FY24 (April-December) is based on CPI-Combined released by MoSPI
 *Gross fiscal deficit data for FY23 is a Revised Estimate, and for FY24 is a Budget Estimate, Current Account Deficit data for FY24 is up to H1 (April-September)

Keeping inflation within the 2 to 6 per cent range was a formidable task during the Covid-19 pandemic, its aftermath, and subsequent fragility in the global economy and polity. Repeated, uneven weather conditions complicated the task. Economic challenges imposed by massive dislocations in production, supply chain, and trade during the pandemic affected the fiscal balance. Supply disruptions led to elevated food prices. Global financial markets experienced extreme volatility, and international crude oil prices tumbled in FY21.

Post-pandemic, FY22 saw a revival of the economy, with growth gaining momentum and inflation coming down. However, by the end of FY22, the global economic environment worsened yet again with the escalation of geopolitical conflicts and accompanying sanctions. Global commodity prices shot up substantially across the board amidst heightened volatility, and crude oil prices jumped

to a 10-year high in June 2022. This spurred inflation globally, which affected India’s external account and price situation. Supply chain pressures, which were set to ease after the pandemic, were rising again.

Elevated edible oil prices due to global supply chain disruptions and higher vegetable prices due to uneven weather conditions led to high food inflation. Thus, the beginning of FY23 presented fresh, multi-frontal challenges to keeping macro vulnerabilities in check. However, India managed to keep its retail inflation below the levels of several other countries. The war in Ukraine and US sanctions led to supply disruptions and price volatility. To insulate the domestic economy from the vulnerabilities in existing supplies of crude oil and natural gas and to reduce dependency on OPEC, the government diversified the supply sources over the last few years and ensured the availability of energy supply at reasonable prices. This, in no small measure, contributed to India’s growth revival.

Inflationary pressures moderated in FY24 (April - December), with average retail inflation easing to 5.5 per cent. The decline was driven by benign trends in core (non - food, non - fuel) inflation, which gradually declined to a 49 - month low of 3.8 per cent in December 2023. The overall retail inflation is now stable and within the notified tolerance band of 2 to 6 per cent.

Persistence food inflation is a global challenge, including in several developed economies. In India, the prices of specific food items were pressured by untimely rains, leading to crop losses and weather-driven supply chain disruptions. Timely focus on supply - side initiatives, based on meticulous price monitoring, is giving credibility to anti - inflationary policies. Measures like strengthening buffers of key food items and making periodic open market releases, trade policy measures aimed at improving domestic availability of food, preventing hoarding through imposition and revision of stock limits, and channelling supplies of select food items through designated retail outlets helped to keep inflationary pressures on the check, amidst adversities. Consequently, India has managed to keep its food inflation at moderate levels and lower than many large economies.

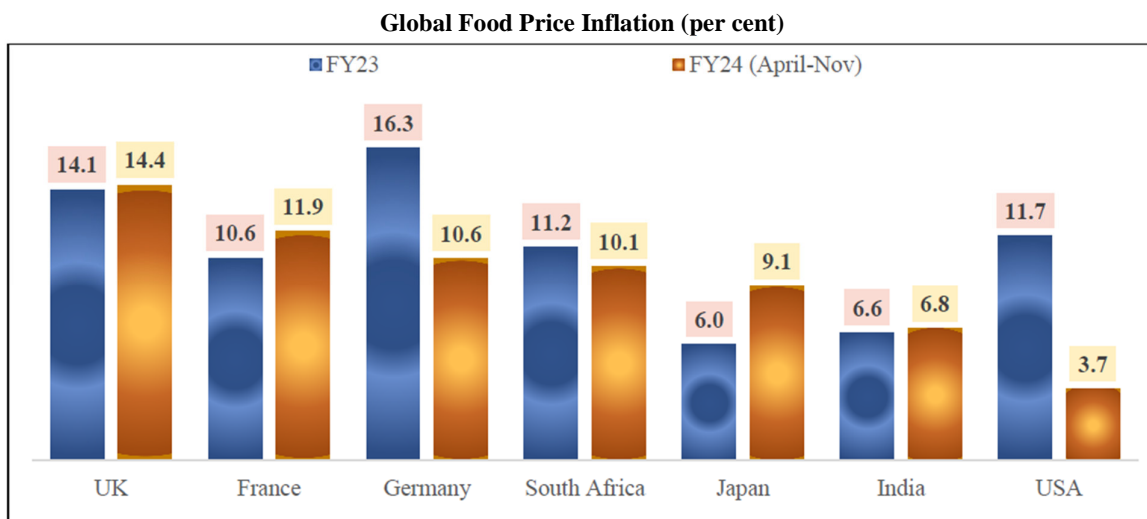

Source: MoSPI for India and OECD for other countries

Supportive monetary policy helped greatly. The RBI increased the policy repo rate under the liquidity adjustment facility progressively from 4 per cent in April 2022 to 6.5 per cent till February 2023 and kept it unchanged thereafter to ensure that inflation aligns with the target while supporting growth. RBI has projected that inflation would average 5.4 per cent in FY24, within the notified tolerance level. With likely improvements in the fiscal balance of the general government and the external current account balance, macro vulnerabilities are again slated to moderate.

Source: https://dea.gov.in/sites/default/files/The%20Indian%20Economy-A%20Review_Jan%202024.pdf?app=true

MANUFACTURING SECTOR IN INDIA

Manufacturing is emerging as an integral pillar in the country’s economic growth, thanks to the performance of key sectors like automotive, engineering, chemicals, pharmaceuticals, and consumer durables. The Indian manufacturing industry generated 16-17% of India’s GDP pre-pandemic and is projected to be one of the fastest growing sectors. The machine tool industry was literally the nuts and bolts of the manufacturing industry in India. Today, technology has stimulated innovation with digital transformation a key aspect in gaining an edge in this highly competitive market.

Technology has today encouraged creativity, with digital transformation being a critical element in gaining an advantage in this increasingly competitive industry. The Indian manufacturing sector is steadily moving toward more automated and process-driven

manufacturing, which is projected to improve efficiency and enhance productivity. India has the capacity to export goods worth US\$ 1 trillion by 2030 and is on the road to becoming a major global manufacturing hub.



With 17% of the nation's GDP and over 27.3 million workers, the manufacturing sector plays a significant role in the Indian economy. Through the implementation of different programmes and policies, the Indian government hopes to have 25% of the economy's output come from manufacturing by 2025.

India now has the physical and digital infrastructure to raise the share of the manufacturing sector in the economy and make a realistic bid to be an important player in global supply chains.

A globally competitive manufacturing sector is India's greatest potential to drive economic growth and job creation this decade. Due to factors like power growth, long-term employment prospects, and skill routes for millions of people, India has a significant potential to engage in international markets. Several factors contribute to their potential. First off, these value chains are well positioned to benefit from India's advantages in terms of raw materials, industrial expertise, and entrepreneurship. Second, they can take advantage of four market opportunities: expanding exports, localizing imports, internal demand, and contract manufacturing. With digital transformation being a crucial component in achieving an advantage in this fiercely competitive industry, technology has today sparked creativity. Manufacturing sector in India is gradually shifting to a more automated and process driven manufacturing which is expected to increase the efficiency and boost production of the manufacturing industry.

India is gradually progressing on the road to Industry 4.0 through the Government of India's initiatives like the National Manufacturing Policy which aims to increase the share of manufacturing in GDP to 25 percent by 2025 and the PLI scheme for manufacturing which was launched in 2022 to develop the core manufacturing sector at par with global manufacturing standards. India is planning to offer incentives of up to Rs. 18,000 crore (US\$ 2.2 billion) to spur local manufacturing in six new sectors including chemicals, shipping containers, and inputs for vaccines.

Manufacturing has emerged as one of the high growth sectors in India. Prime Minister of India, Mr Narendra Modi, launched the 'Make in India' program to place India on the world map as a manufacturing hub and give global recognition to the Indian economy. Government aimed to create 100 million new jobs in the sector by 2022.

Evolution of the Indian manufacturing sector

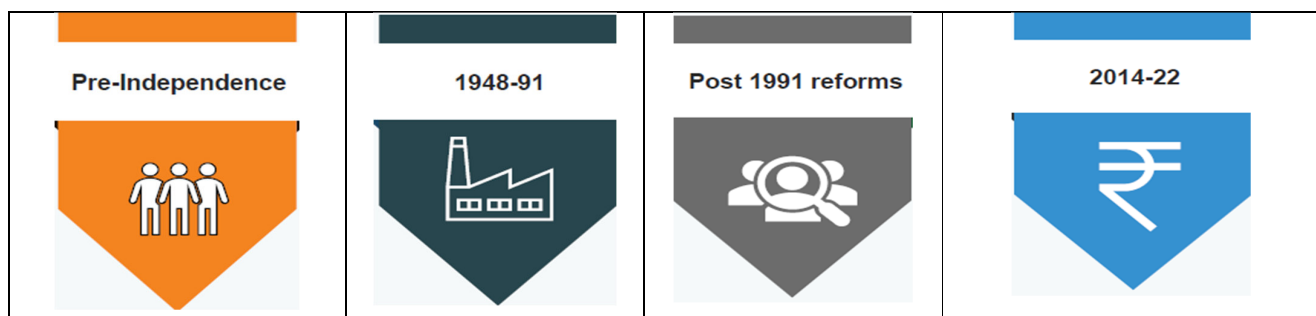

<ul style="list-style-type: none"> • Most of the products were handicrafts and were exported in large numbers before the British era started. • The first charcoal fired iron making was attempted in Tamil Nadu in 1830. • India's present-day largest conglomerate Tata Group started by Jamsetji Tata in 1868. • Slow growth of Indian industry due to regressive policies of the time. • Indian industry grew in the two world war periods in an effort to support the British in the wars. 	<ul style="list-style-type: none"> • Focus of Indian Government on basic and heavy industries with the start of five-year plans. • A comprehensive Industrial Policy resolution announced in 1956. Iron and steel, heavy engineering, lignite projects, and fertilisers formed the basis of industrial planning. • Focus shifted to agro industries as a result of many factors while license raj grew in the country and public sector enterprises grew more inefficient. The industries lost their competitiveness. 	<ul style="list-style-type: none"> • Indian markets were opened to global competition with the LPG reforms and gave way to private sector entrepreneurs as license raj came to an end. • Services became the engines of growth while the industrial production saw volatility in growth rates in this period. • MSMEs in the country were given a push through government's policy measures. 	<ul style="list-style-type: none"> • Make in India campaign was launched to attract manufacturers and FDI. • Government is aiming to establish India as global manufacturing hub through various policy measures and incentives to specific manufacturing sectors. • In FY21, there were 39,539 new business registrations in the manufacturing sector, a 50% increase from 26,406 in FY20. • Electronics, vehicle, and solar panel production account for around 80% of total manufacturing expenditure, with semiconductors/electronics value chain accounting for 50% of total expenditure in February 2022.
--	--	---	---

Note: MSME - Micro, small and Medium Enterprises, FDI - Foreign Direct Investments, SE- Second Estimate

Source: data.gov.in, Central Statistics Office, Indian Express

Capacity utilization in manufacturing sector

- Capacity utilization in the manufacturing sector is measured by Reserve Bank of India (RBI) in its quarterly order books, inventories and capacity utilization survey.
- It indicates not only the production levels of companies but also the potential for future investment.
- As per the survey conducted by the Federation of Indian Chambers of Commerce and Industry (FICCI), capacity utilization in India's manufacturing sector stood at 72.0% in the second quarter of FY22, indicating a significant recovery in the sector.
- In Q2 FY24, the survey, which covered 380 manufacturers that account for about Rs. 4.8 trillion (US\$ 58 billion) in sales, showed a robust 74% capacity utilization and improved future investment outlook during Q2.
- Capacity utilization at manufacturing facilities was at a robust 74.3% in Q3 of FY23, up from 74% in Q2. Utilization has held above the 72% mark since Q3 of FY22, indicating that the manufacturing activity is taking place at a brisk pace.
- As per RBI's Industrial Outlook Survey, manufacturing firms estimated further strengthening of production, orders and employment in the fourth quarter of FY21. Also, the first three months of FY22 were projected to record improvements in capacity utilization, production, business improvement and employment generation.
- At the aggregate level, capacity utilization (CU) for the manufacturing sector recovered to 68.3% in Q2:2021-22 after the waning of the second wave of COVID-19 pandemic in the country, which had caused plummeting of CU to 60.0% in the previous quarter

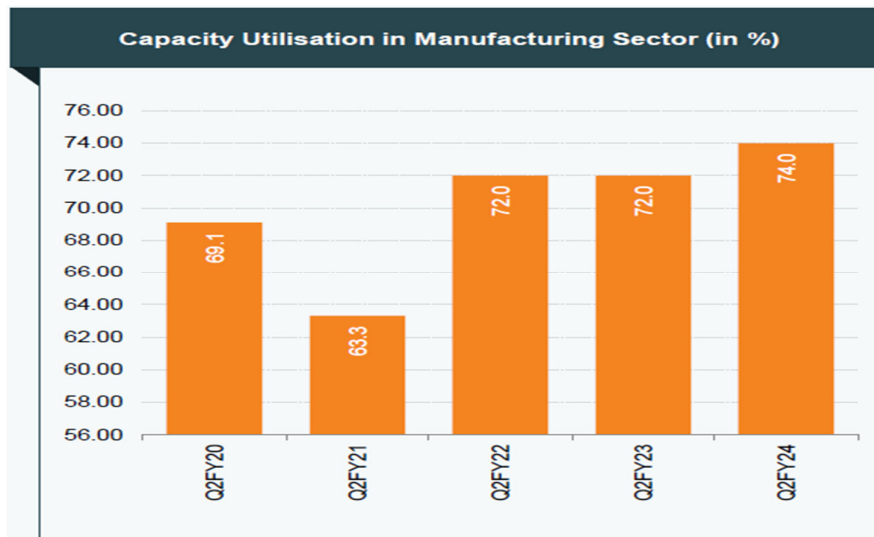

Source: Reserve Bank of India Order Books, Inventories and Capacity Utilization Survey

ROAD AHEAD

India is an attractive hub for foreign investments in the manufacturing sector. Several mobile phone, luxury and automobile brands, among others, have set up or are looking to establish their manufacturing bases in the country. The manufacturing sector of India has the potential to reach US\$ 1 trillion by 2025. The implementation of the Goods and Services Tax (GST) will make India a common market with a GDP of US\$ 3.4 trillion along with a population of 1.48 billion people, which will be a big draw for investors. The Indian Cellular and Electronics Association (ICEA) predicts that India has the potential to scale up its cumulative laptop and tablet manufacturing capacity to US\$ 100 billion by 2025 through policy interventions.

One of the initiatives by the Government of India's Ministry for Heavy Industries & Public Enterprises is SAMARTH Udyog Bharat 4.0, or SAMARTH Advanced Manufacturing and Rapid Transformation Hubs. This is expected to increase competitiveness of the manufacturing sector in the capital goods market. With impetus on developing industrial corridors and smart cities, the Government aims to ensure holistic development of the nation. The corridors would further assist in integrating, monitoring and developing a conducive environment for the industrial development and will promote advance practices in manufacturing.

Source: <https://www.ibef.org/industry/manufacturing-sector-india>

COPPER INDUSTRY

Global Scenario

- The world Copper Mine production from December, 2022 to November, 2023 was about 22,116 thousand metric tonnes (TMT). The share of India in the world production was 25.341 TMT i.e. 0.11% during December, 2022 to November, 2023.
- The world Refined Copper Production from December, 2022 to November, 2023 was about 26,660 TMT against world consumption of 26,784 TMT. As per International Copper Study Group (ICSG) forecast dated 04.10.2023 for the Calendar Year 2023, world Refined Copper production and consumption are projected as 26,351 and 26,357 TMT, respectively. The Projected world Refined Copper production & consumption from December, 2022 to November, 2023 shall be 26,336 and 26,334 TMT, respectively. By comparing the figures of world Refined Copper production and consumption (Forecast) vs. actual from December, 2022 to November, 2023, it is coming around 98.78% and 98.31%. The share of India in the world production was 1.89% during December, 2022 to November, 2023.

Price Outlook

- The average LME price in January 2023 was US\$8,344.30 per tonne compared to average LME of US\$8,999.79 per tonne in January 2022, thereby registering a decrease by 7.28%. The average LME price during the year 2022-23 was US\$8,551.00 per tonne, and cumulative average LME price during 2023-24 (April-January) was US\$8,335.44 per tonne.

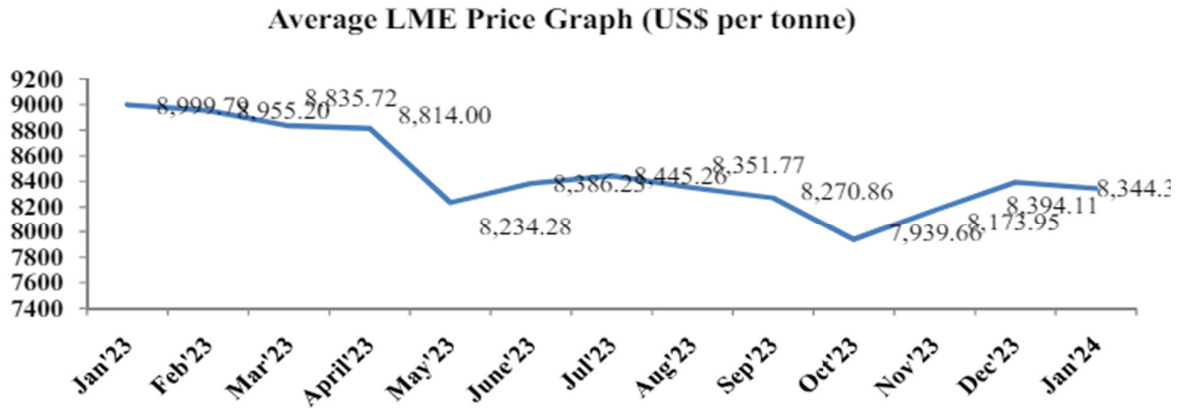
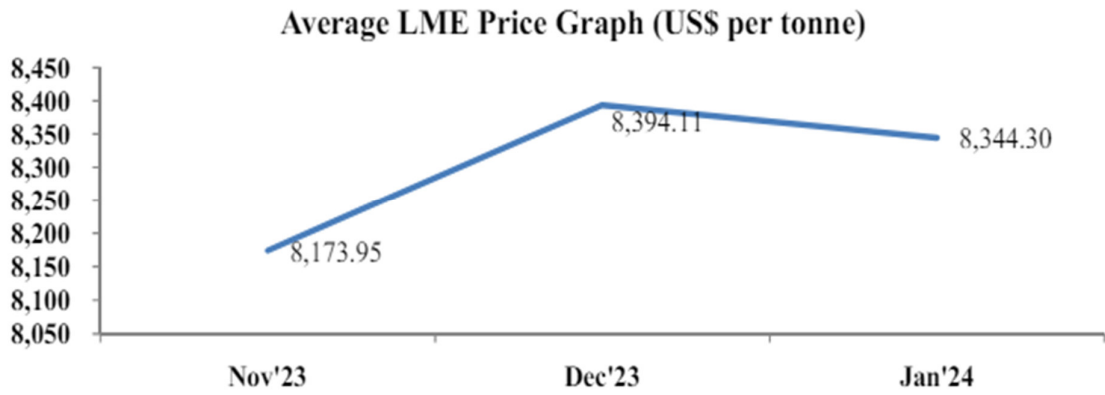

Source: - London Metal Exchange (LME) Aluminium Price Data

Domestic Scenario

- The size of Indian copper industry (consumption of refined copper per annum) is around 6.6 lakh tonnes, which as percentage of world copper market is only three percent.
- Sterlite Industries, Hindalco Industries and Hindustan Copper Ltd. are major producers of refined copper in India.
- Production in India has declined significantly due to the permanent closure of Vedanta’s smelter/ refinery plant of Tamil Nadu in May, 2018.

The production of copper cathode in the organized sector by the public sector unit viz. Hindustan CopperLtd. (HCL), and private sector units viz. Hindalco Industries Ltd. (HINDALCO, Unit Birla Copper) and SesaSterlite Ltd. (SSL) in the country, during FY 2022-23 and the month of January 2024 is as follows:

Capacity and Production during FY 2022-23 is as follows:

(Unit: Lakh Tonnes)

Company	Capacity	Production
HCL	0.685	0.000073
HINDALCO	5.00	4.07
SSL	2.16	1.48
Total	7.85	5.55

Production during the month of January 2024, cumulative production during the period 2023-24 and comparative figures for the previous year is as follows:

(Unit: Lakh Tonnes)

Company	Existing annual capacity (FY 2023-24)	Production (January 2024)		Cum. Production FY 2023-24 (April-Jan)		Production (January 2023)	Cumulative Production FY 2022-23 (April-Jan)
		Target	Actual	Target	Actual		
HCL	0.685*	0	0	0	0	0.000040	0
HINDALCO	5.00	**	0.37	**	2.96	0.36	3.38
SSL	2.16	0.17	0.13	1.44	1.23	0.13	1.27
Total	7.85	0.17	0.50	1.44	4.19	0.49	4.65

Note:

* Installed capacity has been declared on the basis of revised installed capacity of HCL (GCP unit: 50,000 tonnes p.a.; ICC unit: 18,500 tonnes p.a.; and KCC unit is NIL).

** Depends upon various economic factors

*** Metal-in-Concentrate (MIC) produced from ore in HCL is partially converted into refined copper & balance is directly sold in the market.

Capacity and Production of Copper Cathode for FY 2022-23 (Lakh Tonne)

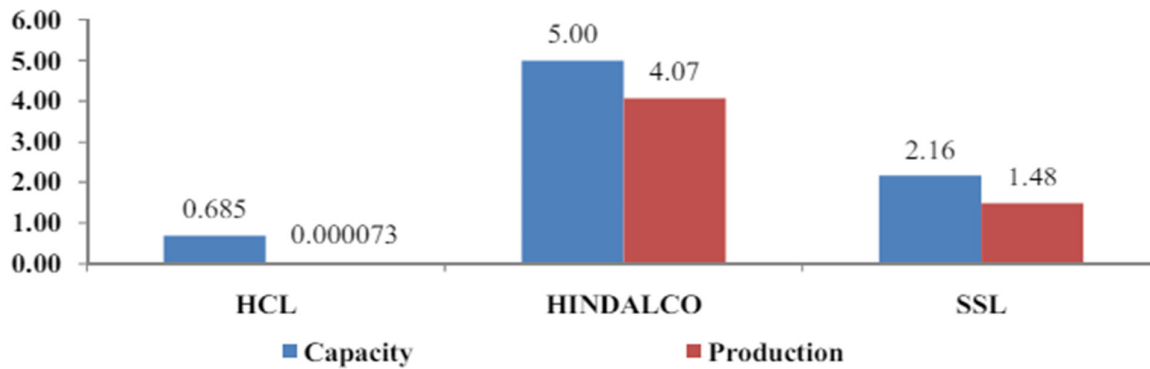

Production details of Copper Cathode for the month of January, 2024 (Lakh Tonnes)

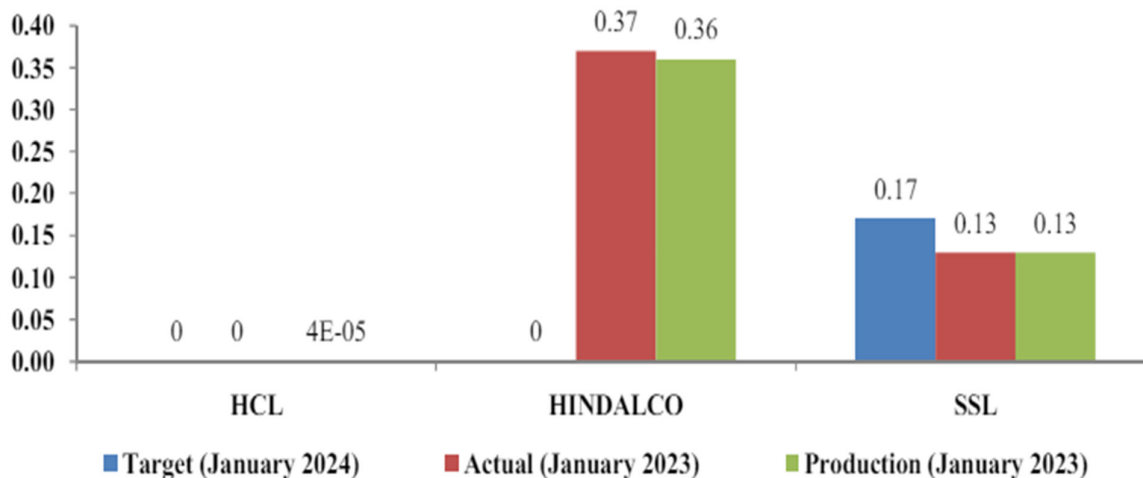

**Cumulative Production details of Copper Cathode for FY 2023-24 (January)
(Lakh Tonnes)**

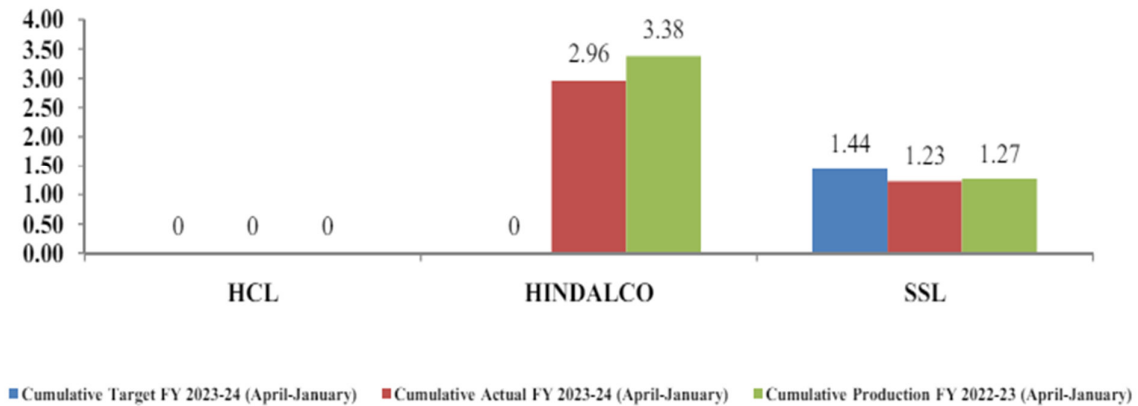

Factors Influencing Copper Markets

- Copper prices in India are fixed on the basis of the rates that rule on LME and Rupee & US Dollar exchange rate.
- Economic growth of the major consuming countries such as China, USA, Japan, Germany, India etc.
- Growth and development in the Infrastructure, Real-estate, Telecom and Electrical Industry, Renewable Energy and Electrical Vehicle Sector.
- Surplus/Deficit in copper market.

Overall Performance of Hindustan Copper Limited

HCL is the only domestic producer of Copper Ore. The production of Copper Ore during January 2024 was 3.34 lakh tonnes. Production during the corresponding period in the previous year was 3.53 lakh tonnes.

The production of Copper metal (cathode) by HCL during January, 2024 was NIL. HCL is selling Metal-in-Concentrate (MIC) in the market directly. The Production of refined Copper (Cathode) by HCL during the corresponding period in the previous year was 3.96 MT. MIC production of HCL during January, 2024 was 2,802 tonnes and it was 2,029 tonnes during the corresponding period in the previous year.

Sr. No.	Particulars	Production (Tonnes)	
		December, 2023	December, 2022
1	Copper Ore	3,34,171	3,53,472
2	Copper Metal (Cathode)	Nil	3.96
3	Metal-in-Concentrate (MIC) (tonnes)	2,802	2,029

Production by HCL (Tonnes)

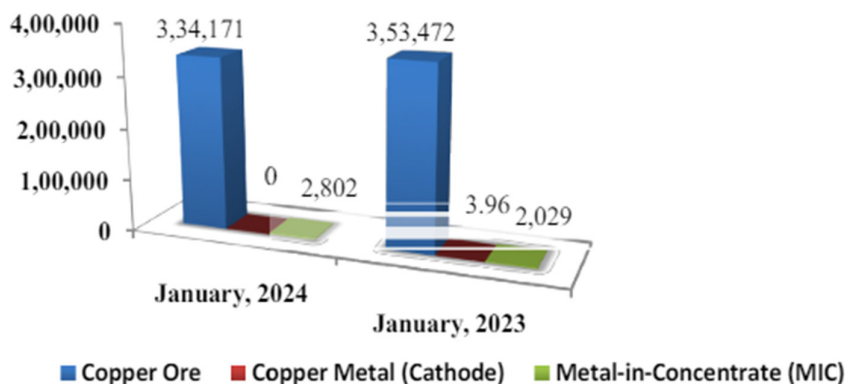

During the month of January, 2024 production of Metal-in-Concentrate was 97% of the target. The sale of copper (cathode, cc wire rod and MIC) during the month of January, 2024 was 2,558 MT

https://mines.gov.in/admin/storage/ckeditor/January_2024_1709620048.pdf

India’s copper consumption to grow by ~11% in FY2024 and FY2025, despite global headwinds

The Central Government’s massive infrastructure development plans, growing urbanization levels, Housing for All schemes, transition to renewable energy along with investment in the metro rail network and railway electrification are likely to sustain domestic copper demand growth.

While global copper consumption growth would remain tepid at ~2% in CY2023, ICRA projects domestic copper demand growth at a healthy ~11% in FY2024 and FY2025.

	Domestic refined copper demand growth is expected to remain healthy at 11% in FY 2024 and FY 2025 outpacing the rate of global growth in copper demand, given the Government of India’s GoI’s thrust on infrastructure development and a gradual transition to renewable energy.
	In the domestic market, around 40% of the copper is consumed by infrastructure and construction sector and 11-13% each in the automobile and consumer durable sectors Significant emphasis by GoI towards affordable housing schemes, smart city projects, the Defence sector as well as the expected higher penetration of EVs and its associated infrastructure bode well for the domestic copper demand outlook.
	The GoI’s ambitious target to achieve 500 GW of renewable energy capacity by 2032 would entail significant capacity additions in the transmission network including for substations and electrical machineries in the coming decade, translating into a healthy domestic copper demand.
	The automotive and transport sector also plays a pivotal role in the overall consumption of copper in India After a stellar performance in FY 2023 automotive demand is expected to remain steady in FY 2024 and FY 2025 Additionally, investment in the metro rail network and railway electrification is also likely to also aide domestic copper consumption in the coming years.
	Lower production of refined copper in India results in a deficit situation in the domestic market, which is being met through higher imports The refined copper imports increased by 30% in FY 2023 and 180% in H 1 FY 2024 However, a new copper smelter of 0.5 million MT mmt by the Adani Group is expected to start from FY 2025 onwards which, once stabilised, is likely to reduce the deficit situation to an extent.
	While the domestic demand is healthy, global copper consumption is likely to remain muted in the current calendar year. In addition, global copper supply is showing signs of improvement, primarily in China, which is likely to result in a surplus metal balance in the current year Thus, copper prices are expected to remain range bound at current levels of 8200- 8300 tonne in the near term at least

Source: <https://www.icra.in/Rating/DownloadResearchSummaryReport?id=5410>

OUR BUSINESS

Some of the information contained in the following discussion, including information with respect to our plans and strategies, contain forward-looking statements that involve risks and uncertainties. You should read the section “Forward-Looking Statements” for a discussion of the risks and uncertainties related to those statements and also the section “Risk Factors” for a discussion of certain factors that may affect our business, financial condition, or results of operations. Our actual results may differ materially from those expressed in or implied by these forward-looking statements. Our fiscal year ends on March 31 of each year, so all references to a particular fiscal are to the Twelve-month period ended March 31 of that year. In this section, a reference to the “Company” or “we”, “us” or “our” means Sunlite Recycling Industries Limited.

All financial information included herein is based on our “Financial information of the Company” included on page 144 of this Prospectus.

OVERVIEW:

We are engaged in the business of manufacturing of copper rods & wires, copper earthing wires, copper earthing strips, copper conductors, copper wire bars etc. through recycling of copper scrap, which has electrical and mechanical properties suitable for applications in power generation, transmission, distribution and electronic industries. Further, we are also engaged in providing job work services for processing of various products of copper, wherein our customers provide us with the copper scrap and we are converting the copper scrap into copper wire and copper wire rod as per customer’s requirement. We employ an internal quality control mechanism to ensure that our finished product conforms to the exact requirement of our customers.

Our promoter, Prahladrai Ramdayal Heda, established a proprietorship concern in the name of 'M/s Sunlite Industries' in 2012, engaged in manufacturing copper rods, wires, bars, strips etc. In September 2017, with the aim of expanding the scope and enhancing business administration, Prahladrai Ramdayal Heda decided to include our other two promoters, Nitin Kumar Heda and Khushboo Manishkumar Heda, as partners and established Partnership firm in the name of “M/s. Sunlite Industries”. Said partnership firm got registered on October 28, 2017 having registration number GUJVA200549 and the business operations continued as a partnership firm till August 2022. Later, the said partnership concern was converted into a private limited company in August 2022, with the objective of carrying on the business of the aforementioned partnership concern as a going concern under the name of Sunlite Alucop Private Limited bearing Corporate Identification Number U27200GJ2022PTC134540 and subsequently, in January 2024, the company changed its name from Sunlite Alucop Private Limited to Sunlite Recycling Industries Private Limited.

We currently operate through our Registered office and manufacturing unit situated at Survey No. 270A and Plot No 1 of Survey No 267, Chhatamile, Tal. Vaso, Dantali, Kheda, 387350 Gujarat, India with a total area of approx. 12,152 sq. mtr. We started our business operations in 2012 as a proprietorship concern and manufacturing only one product i.e. oxygen-free copper rods. Later in year 2015-16, we expanded our area of operation by developing one more shed and installing copper strip machine with an installed capacity of 350 MT, which was imported from China, thereby started manufacturing of copper strips along with copper rods. Then in year 2017-18, we purchased wire-drawing machine and started manufacturing of copper wire. Subsequently, after entering into the partnership firm to expand our business operations, we purchased Copper CCR Machine in year 2020, with resulted into a significant surge in our revenue from operations. As on the date of this Prospectus, we have a total of 20 machines to manufacture wide range of copper products.

Our Product Portfolio offers a diversified product range which includes variety of grades, thickness, widths and standards, in all types of copper products according to customer specifications. We prioritize environmental and safety considerations in our copper production process. Our approach involves recycling copper scrap utilizing electricity sourced from solar generation and clean natural gas, thus mitigating the pollution associated with conventional oil-based energy sources. Copper is one of the most recycled metals of all the metals. The recycling of copper scrap is gaining importance worldwide simply because of the fact that recovery of copper metal from scrap requires much less energy than its recovery made from primary source. Besides, it enables conservation of natural resources. (Source: Indian Bureau of Mines).

Our Company is managed by our Promoters - Prahladrai Ramdayal Heda, Nitin Kumar Heda, Khushboo Manishkumar Heda and Manish Kumar Heda. Prahladrai Ramdayal Heda (chairman and whole-time director of the company and Partner of erstwhile M/s Sunlite Industries) is responsible for quality control, process improvement, Operations & Management, HR & administration. He ventured into the business of manufacturing of copper rods in year 2012 and since then, he has gained a good knowledge and experience of 15 years in this industry. Nitin Kumar Heda (Managing Director of the company and partner of erstwhile M/s Sunlite Industries) who has approx. 17 years of experience in same industry, is responsible for financial aspects of the company along with marketing, vendor management, business planning and development. Khushboo Manishkumar Heda (Non-Executive Director of the company and partner of erstwhile M/s Sunlite Industries) has approx. 06 years of experience in same industry. Manish Kumar Heda (Chief Financial Officer of the company and employee of erstwhile M/s Sunlite Industries) has approx. 15 years of experience in same industry, is responsible for financial activities of the company including finance, statutory compliance, business development, Sales & Marketing, general operations, customer relations management of the Company. Their understanding of the consumer difficulty, intuitive entrepreneurship and involvement in key aspects of our business has helped accelerate and drive our

profitable growth. We believe that the sector-specific experience and expertise of our promoters has contributed significantly in the growth of our Company.

We have a strong track record of revenue growth and profitability. The following table sets forth certain key performance indicators for the years indicated:

(Rs. In Lakhs except percentages and ratios)

Key Financial Performance	For the financial year ended		
	March 31, 2024	March 31, 2023	March 31, 2022
Revenue from Operations ⁽¹⁾	1,16,627.09	1,15,018.88	93,719.32
EBITDA ⁽²⁾	1,836.07	1,422.88	990.75
EBITDA Margin ⁽³⁾	1.57%	1.24%	1.06%
Profit After Tax (PAT) ⁽⁴⁾	890.36	560.27	426.03
PAT Margin ⁽⁵⁾	0.76%	0.49%	0.45%
ROE ⁽⁶⁾	75.26%	73.69%	47.85%
ROCE ⁽⁷⁾	29.49%	24.05%	22.85%
Net Worth ⁽⁸⁾	2,003.90	362.08	1,158.58

Notes:

⁽¹⁾ Revenue from Operations means the Revenue from Operations as appearing in the Restated Financial Statements.

⁽²⁾ EBITDA is calculated as Profit before tax + Depreciation + Interest Cost – Other Income

⁽³⁾ 'EBITDA Margin' is calculated as EBITDA divided by Revenue from Operations

⁽⁴⁾ PAT is calculated as Profit before tax – Tax Expenses

⁽⁵⁾ PAT Margin' is calculated as PAT for the year divided by revenue from operations.

⁽⁶⁾ Return on Equity is ratio of Profit after Tax and Shareholder Equity

⁽⁷⁾ Return on Capital Employed is calculated as EBIT divided by capital employed, which is defined as shareholders' equity plus total borrowings {current & non-current}.

⁽⁸⁾ Net Worth = Equity Share Capital + Reserve and Surplus (including surplus in the Statement of Profit & Loss) - Preliminary Expenses to the extent not written-off.

OUR STRENGTHS

We believe that the following are our primary strengths:

Strong portfolio and diverse range of copper products:

Our company manufactures diverse range of copper products which includes copper rods & wires, copper earthing wires, copper earthing strips, copper conductors, copper wire bars etc. catering to every aspect of electrical transmission and distribution, power generation, and electronic applications. We deal in a wide range of products, which enables us to cater widespread customer base across various states in India. We believe that we have necessary resources, experience and network to launch additional products in future. With an operating history of more than a decade, we are primarily known for our wide range of quality products at a competitive price.

Below is the summary of our Product-wise revenue over last three years:

PARTICULARS	FY 2023-24	% to Total Sales	FY 2022-23	% to Total Sales	Rs. in Lakhs	
					FY 2021- 22	% to Total Sales
Copper Rod	1,04,562.48	89.66	1,02,706.31	89.30	83,209.07	88.79
Copper Wire	7,187.97	6.16	8,335.16	7.25	6,667.98	7.11
Copper Strips	2,266.71	1.94	1,658.08	1.44	2,707.68	2.89
Others	2609.92	2.24	2,319.34	2.02	1134.58	1.21
Total	1,16,627.09	100.00	1,15,018.89	100.00	93,719.32	100.00

Stringent quality control mechanism ensuring standardized product quality

Our Company believes in maintaining the quality for our product offerings. We are dedicated towards quality of our products. We adhere to quality standards as prescribed by our customers and employ an extensive and stringent quality control mechanism at each stage of the manufacturing process, which are required to ensure that our finished product conforms with the exact requirement of our customers and successfully passes all validations and quality checks. Further, as a certification of the quality assurance, our Company has received ISO 9001:2015 for quality management systems. We believe that our focus on quality of products has enabled us to sustain and grow our business model to benefit our customers.

Revenue from multiple geographies in India:

Our Company has diversified revenue from multiple geographical locations from various states in India. We have generated around 92.80 % and 93.27% of our total revenue from sales in top 05 geographical regions in India for the financial year ended March 31, 2024 and March 31, 2023. Currently, we are selling our products to more than 10 states and union territories in India of which majority portion of the revenue comes from the state of Gujarat which contributes 45.73% of total revenue followed by Dadra & Nagar Haveli which contributed 21.49% of total revenue. Apart from this, Maharashtra contributed 12.75%, Telangana contributed 9.06% & Madhya Pradesh contributed 3.77% of our total revenue from operations. The other 8 states and Union territories such as Tamil Nadu, Rajasthan, Goa etc. contributed approx. 7.21% of total revenue from operations. The company also exported its products to Nepal in F.Y. ending 2021-22 and 2022-23 amounting to Rs. 707.98 Lakhs and Rs. 545.05 Lakhs respectively, which accounted for 0.76% and 0.47% of the total revenue of the company respectively, for the said period. Our presence in multiple geographies not only helps us in expanding our customer base but also helps us by keeping ourselves in tune with the latest technological advancements and help us to mitigate risk for any unforeseen circumstances in the domestic market and expand our business operations.

Our revenue from top five geographies in India in last three years is as follows:

Name of State	31-Mar-24	% to total sales	31-Mar-23	% to total sales	Rs. in Lakhs	
					31-Mar-22	% to total sales
Gujarat	53,329.50	45.73	51,275.98	44.58	35,718.51	38.11
Dadra and Nagar Haveli	25,068.26	21.49	22,178.12	19.28	8,408.67	8.97
Maharashtra	14,870.54	12.75	17,861.43	15.53	12,000.75	12.80
Telangana	10,571.62	9.06	10,615.85	9.23	25,805.90	27.54
Madhya Pradesh	4,394.53	3.77	5,349.60	4.65	4,839.38	5.16
Total	1,08,234.45	92.80	1,07,280.98	93.27	86,773.21	92.58

Experienced Senior Management

We have an experienced and qualified management team led by our Promoters Prahladrai Ramdayal Heda, Nitin Kumar Heda and Khushboo Manishkumar Heda. Prior to the incorporation of our company, our promoter Prahladrai Ramdayal Heda was carrying on the business of manufacturing oxygen free copper rods, as a proprietorship concern since year 2012 under the name of “M/s Sunlite Industries” and subsequently from year 2017, all three promoter’s carried on the business operations under a partnership concern named “M/s Sunlite Industries” focusing on the production of copper wire, copper wire rods, copper wire bars, copper strips, etc. Since then, Prahladrai Ramdayal Heda have gained a good knowledge and experience of around 15 years and Nitin Kumar Heda and Khushboo Manishkumar Heda have gained a knowledge and experience of around 17 years and 06 years respectively in this industry. Thus, we are well placed to capitalize the knowledge and experience of our management team which has been instrumental in growth of our Company and enables us to capture market opportunities, formulate and execute business strategies, manage customer expectations as well as proactively respond to changes in the market conditions. For details regarding the Key Managerial Personnel, please refer to chapter titled “*Our Management*” on page 125 of this Prospectus.

OUR STRATEGIES:

Continue to invest in our technological capabilities

Our Company intends to enhance its existing manufacturing capabilities of copper components through investment of Rs. 404.55 Lakhs in additional plant & machineries, which are to be funded from net issue proceeds. In order to enhance the production capacity, we intend to purchase machines such as Hydraulic Drawing & Tension Straightening Machine, High Speed electrolytic tinning machine, Fine Wire Drawing Machine and Double Twist Bunching Machine which will be used for manufacturing of Copper Busbars, Tinned Copper Wire, Tinned Coated Bunched Copper Wire etc., which has electrical properties suitable for power generation, transmission, distribution and electronic industries and is in significant demand due to its extensive use across such industries owing to its corrosion resistance and durability.

We believe that this investment will enhance operational efficiency and cost-effectiveness in our existing manufacturing process owing to its future expected demand. Thus, going forward, we intend to continue making investments in capacity expansions and modernization of our equipment and facilities to further enhance our operational efficiencies to increase economies of scale, absorb fixed costs more effectively, reduce other operating expenses, and strengthen our competitive position. Our focus will be on improving capacity utilization at our production facilities by increasing our overall production volumes. For further details, please refer to chapter titled “*Objects of the Issue*” beginning on page 70 of this DRHP.

Enhancing brand image & meeting quality standards

Our manufacturing unit has accreditations such as ISO 9001:2015 for quality management systems assessed by International Certification & Inspection UK Ltd. Further, we are members of All Ind. Non-Ferrous Metal Exim Association, Material Recycling Association of India and Bombay Metal Exchange Ltd. Our Company intends to focus on adhering to the quality standards of the components as we understand that curtailing cost without compromise on quality is an important factor to be considered for operation

of business. This is necessary so as to make sure that we get repeat orders from our customers. Continuous quality review of products and timely corrective measures in case of quality diversion are keys for maintaining quality standards of the products. Providing the desired and good quality products help us in enhancing customer trust and creating goodwill of the Company. This will also aid us in enhancing our brand value. We intend to continue to build our brand image by providing quality products to the satisfaction of our clients. We believe that this can be achieved through detailed analysis of our processes and continuous process improvement along with keeping pace with technology development.

Expand our geographical presence

Currently, we market our products to more than 10 states and union territories of which majority portion of the revenue comes from the state of Gujarat, Dadra & Nagar Haveli and Maharashtra. Going forward, we intend to deepen penetration and strengthen our position in our existing key market areas such as Maharashtra, Telangana, Madhya-Pradesh & Tamil Nadu. Further, we seek to tap other markets and increase our geographical presence by leveraging our experience in key market areas where we believe we can provide cost advantages to our clients and distinguish ourselves from other competitors. We intend to cater to the increasing demand of our existing customers and also to increase our existing customer base by enhancing the reach of our products in different parts of the country. We aim to achieve this by adding value to our customers through quality assurance, timely delivery and reliability.

Strong and diversified supplier base for sourcing raw material

One of the critical factors to grow and develop in our business is the ability to source raw materials. The essential raw material used by our manufacturing unit for production of copper components is copper based metal scrap, which we procure from various global suppliers located in Saudi Arabia, UAE, USA etc. along with domestic suppliers. Given that raw material expense constitutes a significant portion of our overall cost, we benefit from a globally spread out and diversified supplier base. This enables us to negotiate favorable terms and even avail better discounts. We will continually strive to maintain strong relationships with our suppliers in order to derive better insight into the markets for our raw materials, which helps us to manage our raw material supply chain, resulting in greater predictability of supply and, consequently, a greater ability to meet production schedules and achieve on time delivery for our customers.

OUR PRODUCTS:

1. COPPER RODS

- **Oxygen Free Copper Rods(OFC):**

OFC is a high-purity copper alloy that has been refined to remove all traces of oxygen and other impurities. It is known for its excellent electrical conductivity, thermal conductivity, and low susceptibility to embrittlement. It is also one of the conductors that generate less internal heat than any other grade of copper.

We produce OFC rods in variety of sizes including 8mm, 12.5mm, 16mm, 20mm and 24mm. OFC rods are produced with the use of induction furnace technology. Induction furnace technology is a type of electrical furnace used for melting metals like iron, copper, aluminium etc. It utilizes electromagnetic induction to generate heat for melting metal which is a clean and effective fuel source with little environmental impact.

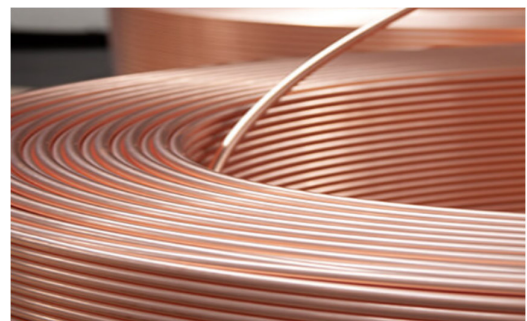

- **Fire-Refined High Conductivity Copper Rods-(FRHC):**

Fire-Refined High Conductivity Copper Rods are a specific type of copper alloy known for its excellent thermal and electrical conductivity. FRHC copper rods are used in various industrial applications, including roofing, skylight frames, flashing, and fasteners.

FRHC copper is employed in chlorine cells, printing rolls, chemical process equipment, and pressure vessels. They serve as bus bars, panel boards, lead frames, and terminal connectors. FRHC copper is utilized in the form of a brazing filler metal.



2. COPPER WIRES:

Copper wires conduct electrical currents that power our homes and electrical appliances we use every day. Copper wire is the preferred conductor for many electrical applications because of the high conductivity of copper, which contributes to its optimal performance.

Copper efficiently transfers heat, making it valuable in heat exchangers and other thermal applications. It resists corrosion, ensuring its longevity. Copper can be easily drawn into wires without losing its properties. Below are different types of copper wires:

- **Copper Earthing Wires:**

Copper earthing wires play a crucial role in electrical safety systems. The earthing or grounding system involves connecting the metallic components of electric machinery and devices to an earth plate (ground rod) or earth electrode via an earth lead (grounding conductor) buried in moist soil.

This connection is established using a thick copper conductor wire with very low resistance for safety reasons.

- **Copper conductors:**

A copper conductor refers to a wire or cable made primarily of copper that is used to carry electrical current. Copper is a popular choice for conductors due to its excellent electrical conductivity, thermal conductivity, corrosion resistance, and malleability. It is widely used in various applications, including electrical wiring in buildings, power transmission and distribution lines, electronic devices, and telecommunications systems.

Manufacturing of copper conductors at our manufacturing unit includes Round Copper Braids and Standard Copper conductors. Round Copper Braids and Standard Copper conductors are the raw material which is generally used by cables companies to cover cables with PVC coating which is used for electricity purposes.

- **Copper Submersible Wires:**

Copper submersible wires are essential for powering submersible pumps, especially in applications where the wires are submerged in water. These wires are designed to withstand moisture, corrosion, and mechanical stress.

These cables are specifically engineered for submersible pump installations, where durability and reliable performance are crucial. These are produced using wire drawing machines. Depending on the intended use, the drawn copper wire may be further processed for specific applications

3. COPPER STRIPS:

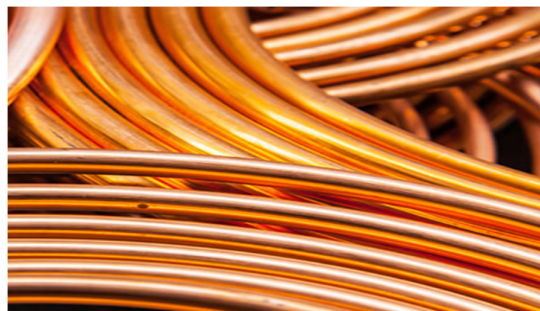
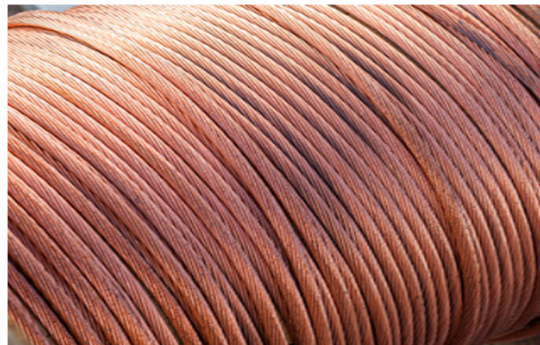

Copper strips are thin, flat pieces of copper that come in various widths and thicknesses. Copper strips exhibit excellent electrical and thermal conductivity. Copper is known for its corrosion resistance, ensuring durability even in challenging environments. Copper strips are malleable, allowing for precise shaping and forming. These strips are durable and can withstand mechanical stress.

The oxygen-free copper rod is fed into an extrusion machine to form copper strips. Depending on the specific requirements, the strip can be further processed to create different types of copper strips, such as flat strips, thin strips, or customized profiles.

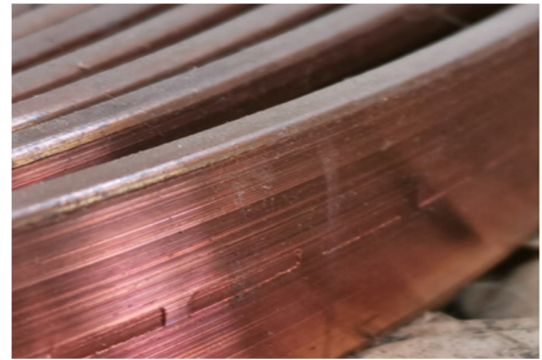

OUR LOCATIONS:

Currently we are operating from the following offices in India:

Registered Office and Manufacturing Unit	Survey No. 270A & Plot No. 1 Survey No. 267, Chhatha Mile, Dantali, Vaso, Kheda -387350, Gujarat, India.
Marketing Office	Office No. 905, 9th floor, Millennium Empire, Sector 15, Panvel, Navi Mumbai – 410210, Maharashtra, India.





OUR MANUFACTURING PROCESS-

Set forth below is a brief description of the process carried out in our manufacturing unit to manufacture Copper rod, Copper Strip and Copper wire & Copper Conductor.

Manufacturing Process for Copper rod

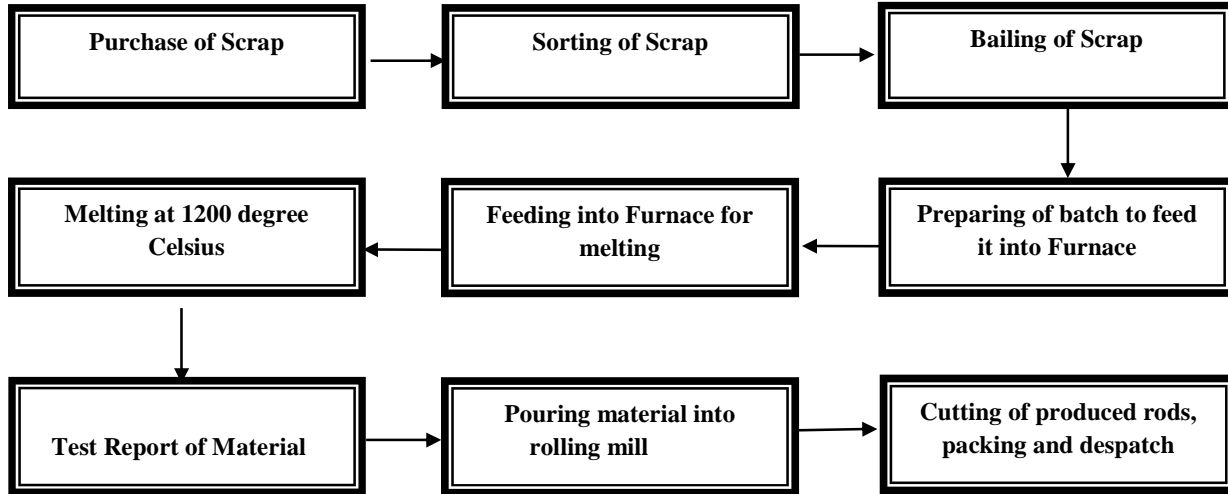

The manufacturing operations described through above diagram is explain as follows:

1. **Purchase of Scrap:** The process begins with the purchase of copper scrap which is the major raw material for production of copper rods and is procured from various global suppliers located in Saudi Arabia, UAE, USA along with domestic suppliers.
2. **Sorting of Scrap:** The collected scrap is sorted based on its quality and composition. This step ensures that only suitable material is used for further processing.
3. **Bailing of Scrap:** Once sorted, the scrap is compacted into bales for easier handling and transportation. Baling helps optimize storage space and facilitates efficient movement within the production facility.
4. **Preparing of batch to feed it into Furnace:** The baled scrap is then prepared in batches to be fed into the furnace. These batches ensure consistent quality and facilitate efficient melting.
5. **Feeding into Furnace for melting:** The prepared batches of copper scrap are fed into an induction melting furnace. Inside the furnace, the copper cathodes (pure copper) are melted into liquid form.
6. **Melting at 1200 degree Celsius:** The molten copper is heated to a temperature of approximately 1200°C (2192°F). This high temperature ensures complete melting and homogenization of the copper.
7. **Test Report of Material:** After melting, a sample is taken for testing. The test report verifies the quality of the batch, including its chemical composition and purity.
8. **Pouring material into rolling mill :** Once the batch passes quality checks, the melted copper is poured into a continuous casting machine. This machine solidifies the copper into long rods. The rods are then guided through a series of rollers in a rolling mill to achieve the desired shape and dimensions.
9. **Cutting of produced rods, packing and despatch:** Finally, the produced copper rods are cut to specific lengths, inspected, and packaged. They are ready for dispatch to various industries where they will be used for electrical wiring, conductors, and other applications.

Manufacturing Process for Copper wire and Conductor

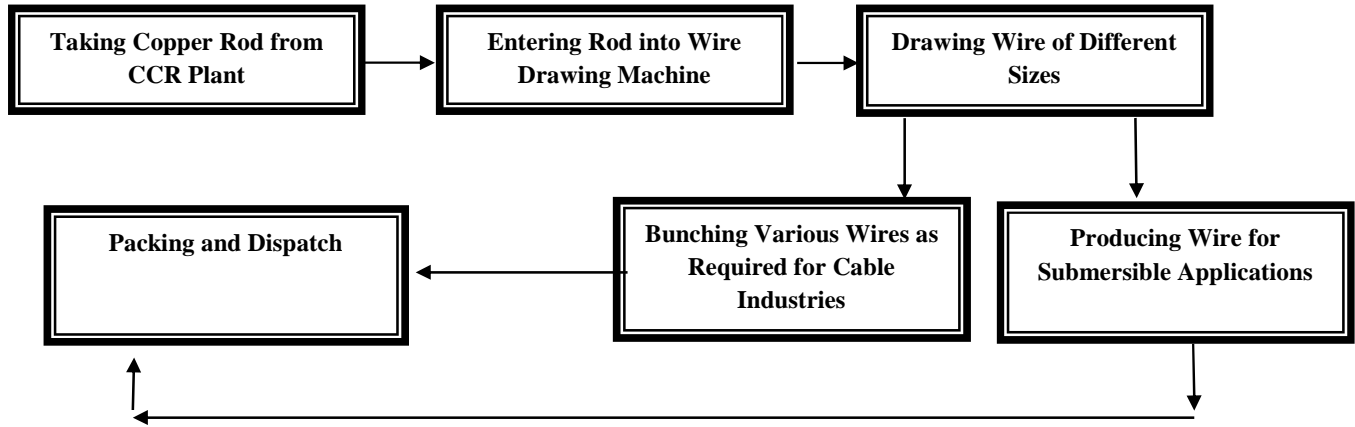

The manufacturing operations described through above diagram is explain as follows:

1. **Taking Copper Rod from CCR Plant:** The process begins with obtaining copper rods from the Continuous Cast Rod (CCR) plant. These rods serve as the raw material for wire production.
2. **Entering Rod into Wire Drawing Machine:** The copper rods are then fed into a wire drawing machine. This machine gradually reduces the rod’s diameter by pulling it through a series of dies. As the rod passes through these dies, it transforms into thinner wire of various gauges.
3. **Drawing Wire of Different Sizes:** The wire drawing process continues until the desired wire sizes are achieved. Engineers meticulously adjust the dies to create wires suitable for specific applications. Copper wire drawing lubricants are often used during this process to enhance the wire’s malleability and extend die life.
4. **Producing Wire for Submersible Applications or Bunching Various Wires as Required for Cable Industries:** Depending on the intended use, the drawn copper wire may be further processed for specific applications like submersible applications or bunching the wires for use in cable industries.

For submersible pumps, the wire undergoes additional treatments to ensure durability and resistance to water exposure. Otherwise, the drawn wires can also be used to create conductors for cables where multiple individual copper wires are bunched together which enhances flexibility, electrical performance, and overall strength. The grouped wires form the core of electrical cables.

5. **Packing and Dispatch:** If the bunched wires or the submersible wires meet quality standards, they are inspected, coiled, and packed are ready for dispatch industries where they will be used for power transmission, communication, and more.

Manufacturing Process for Copper Strip

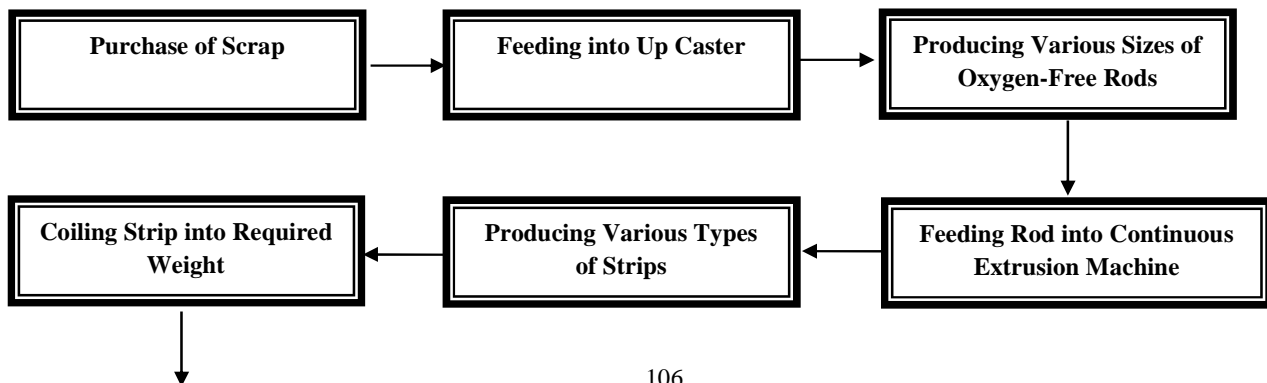

Packing and Dispatch

The manufacturing operations described through above diagram is explain as follows:

1. **Purchase of Scrap**: The process begins with the procurement of copper scrap, procured from various global suppliers located in Saudi Arabia, UAE, USA along with domestic suppliers.
2. **Feeding into Up Caster**: The copper scrap is fed into an up caster. An up caster is a machine that continuously casts melted metal into a solid form. In this step, the copper is transformed into a continuous rod or billet.
3. **Producing Various Sizes of Oxygen-Free Rods**: The continuous rod obtained from the up caster is further processed to create various sizes of oxygen-free copper rods. Oxygen-free copper (also known as OFC) is highly conductive and is commonly used in electrical applications.
4. **Feeding Rod into Continuous Extrusion Machine**: The oxygen-free copper rod is then fed into a continuous extrusion machine. The extrusion process involves forcing the copper through a die to shape it into the desired cross-sectional profile (such as rectangular, square, or circular).
5. **Producing Various Types of Strips**: The extruded copper is now in the form of a continuous strip. Depending on the specific requirements, the strip can be further processed to create different types of copper strips, such as flat strips, thin strips, or customized profiles.
6. **Coiling Strip into Required Weight**: The produced copper strips are coiled into manageable rolls or spools. These coils are typically wound to a specific weight or length, making them easier to handle during subsequent processes.
7. **Packing and Dispatch**: Finally, the coiled copper strips are inspected, quality-checked, and packaged. They are ready for dispatch to various industries, where they will be used for electrical components, connectors, heat exchangers, and more.

PLANT AND MACHINERY

Some of the major machineries installed in our factory includes Confirm Machine, Wire Drawing Machine, CCR Machine, Bailing Machine, Cable Machine etc. which are owned by the company.

PRODUCTION AND INSTALLED CAPACITY:

Particulars	For the financial year ended		
	March 31, 2022	March 31, 2023	March 31, 2024
COPPER RODS			
Installed Capacity (MT)	14180.00	16580.00	16580.00
Actual Production (MT)	11497.25	14426.36	14455.23
Capacity Utilization (in %)	81.08%	87.01%	87.18%
COPPER WIRES			
Installed Capacity (MT)	1900.00	1900.00	1900.00
Actual Production (MT)	917.43	1178.23	1066.57
Capacity Utilization (in %)	48.29%	62.01%	37.23%
COPPER STRIPS			
Installed Capacity (MT)	720.00	720.00	720.00
Actual Production (MT)	377.02	234.69	312.58
Capacity Utilization (in %)	52.36%	32.60%	43.41%
TOTAL CAPACITY UTILIZED			
Total Installed Capacity (MT)	16800.00	19200.00	19200.00
Actual Production (MT)	12791.7	15839.28	15834.38
Capacity Utilization (in %)	76.14%	82.50%	82.47%

Above capacity utilisation has been certified by M/s. Krishnakant A. Pandat, Chartered Engineer, vide certificate dated August 03, 2024.

COLLABORATIONS/TIE UPS/ JOINT VENTURES

Except as disclosed in this Prospectus and in the normal course of business, we do not have any Collaboration/Tie Ups/ Joint Ventures as on date.

EXPORT OBLIGATION

As on date of the Prospectus our company has no outstanding export obligation

SALES AND MARKETING: -

The efficiency of the marketing and sales network is a critical success factor of our Company. Our success lies in the strength of our relationship with our customers who have been associated with our Company for a long period. To retain our customers, our Promoters and senior management team, who have vast experience in this industry, regularly interact with them and focus on gaining an insight into the additional needs of such customers. Further, as a part of our marketing strategy, we employ marketing technique such as participation in various events and fairs, which gives us platform to exhibit our products to enhance our existing customer base.

COMPETITION:

The copper recycling industry is extremely competitive where the key factors of competition primarily comprise of product quality, cost, delivery, development and management. In this highly competitive industry, we compete with other copper alloy manufacturers and suppliers in the world and in India. Some of our competitors have better penetration in some of the geographical locations that we operate in. We believe that with our cost effective and integrated facility, our focus on customer satisfaction and our reliability combined with our quality consciousness provides us with competitive advantage in many of our products. While these factors are key parameters in-client's decisions matrix in purchasing goods; product range, product quality and product price is often the deciding factor in most of the deals. Some of our significant competitors in the organized segment includes Rajnandini Metal Limited and Bhagyanagar India Limited.

INFRASTRUCTURE & UTILITIES:

- **Raw Material:** The essential raw material used by our manufacturing unit for production of copper rods, copper wires & copper strips is copper scrap, which we procure from various global suppliers located in Saudi Arabia, UAE, USA etc. along with domestic suppliers. Details of raw materials sourced domestically and imported by the Company for the F.Y. ending 2021-22, 2022-23 & 2023-24:

Particulars	FY 2023-24	% to Total Purchase	FY 2022-23	% to Total Purchase	Rs. in Lakhs	
					FY 2021- 22	% to Total Purchase
Domestic Purchase	80,341.58	72.69	1,01,945.96	90.66	91,206.76	99.10
Import Purchase	30,172.67	27.31	10,503.69	9.34	828.48	0.90
Total Purchases	1,10,514.27	100.00	1,12,449.65	100.00	92,035.24	100.00

- **Power:** We have made necessary arrangements for regular uninterrupted power supply at our manufacturing unit. The requirement of power for our operations, like power for lighting and operating the plant/machinery/equipment is met through the state electricity board i.e. Madhya Gujarat Vij Company Ltd. having sanctioned electricity load of 1900 KVA.

In addition to the said sanctioned power, we have installed rooftop solar system of DC Capacity of 501 KW at our manufacturing unit to generate green energy and cost effectiveness. With the usage of solar energy, we also employ sustainable fuels like natural gas for our production processes, which decrease air pollution and further reduce the negative effects on the natural world. We also have two (2) DG sets which is used in case of power fluctuation.

- **Water:** The existing water requirement for our manufacturing unit is met from Borewell.

HUMAN RESOURCES

We believe that our ability to maintain growth depends to a large extent on our strength in attracting, training, motivating and retaining employees. As on March 31, 2024, our company has employed 38 permanent full-time employees including managerial personnel. Our manpower is a prudent mix of the experienced and youth which gives us the dual advantage of stability and growth.

Our service processes and skilled/ semi-skilled resources together with our strong management team have enabled us to successfully implement our growth plans.



The company has a contract with a third-party contractor to supply labour for its manufacturing unit. The number of contract labourers varies based on the nature and scope of the work.

INSURANCE

Our operations are subject to accidents which are inherent to any business such as risks of employee accidents, fire, earthquakes, flood and other force majeure events, acts of terrorism and explosions including accidents that may cause injury and loss of life, severe damage to and the destruction of property and equipment and environment. We have taken National Bharat Sookshma Udyam Suraksha Policy i.e. Standard Fire & Special Perils Insurance Policy from National Insurance for our Registered office & manufacturing unit which provide insurance against loss from fire, explosion, lighting, earthquake, volcanic eruptions, riots, strike, malicious damage etc. We have also taken Marine Cargo Open Policy Insurance from National Insurance which covers expenses and financial liabilities that are incurred in the transportation of goods and other items along with Vehicle Insurance policy from Future Generali total insurance solutions and Employees compensation insurance from National Insurance. For further details, please refer to Risk factor **“Our insurance coverage may not be adequate to protect us against all potential losses to which we may be subject and this may have a material effect on our business and financial condition”** on page 25 of this Prospectus.

INTELLECTUAL PROPERTIES

The details of trademark used by our Company are: -

S. No.	Brand name/ Logo Trademark/Copyright	Class	TM Category	Applicant	Trademark Number/ Application No./ Registration Certificate Number	Issuing Authority	Date of Application	Status
1.		6	Device	Sunlite Recycling Industries Limited	TM Application No: 6434402	Registrar of Trademark	May 15, 2024	Formalities Chk Pass
2.		6	Device	Sunlite Industries	Application No. 3796778 Certificate No. 1996711	Registrar of Trademark	April 04, 2018	Registered

IMMOVABLE PROPERTIES

The following table sets forth the locations and other details of the properties of our Company:

S. No.	Details of the Properties	Actual use	Owned/ Leased/Rented
1.	Survey No. 270A & Plot No. 1 Survey No. 267, Chhatha Mile, Dantali, Vaso, Kheda -387350, Gujarat, India.	Registered Office & Manufacturing Unit	Rented- The said property has been obtained on rent vide rent agreement dated February 06, 2024 from Mr. Nitin Kumar Heda for a period of 11 months w.e.f. February 01, 2024.
2.	Office No. 905, 9th floor, Millennium Empire, Sector 15, Panvel, Navi Mumbai – 410210, Maharashtra, India.	Marketing Office	Leased- The said property has been obtained on lease vide leave & license agreement dated May 15, 2024 from Mr. Krishnaswamy Suresh for a period of 22 months w.e.f. May 15, 2024.

KEY REGULATIONS AND POLICIES

The following description is a summary of the relevant regulations and policies as prescribed by the Government of India, and the respective bye laws framed by the local bodies, and others incorporated under the laws of India. The information detailed in this Chapter has been obtained from the various legislations, including rules and regulations promulgated by the regulatory bodies and the bye laws of the respective local authorities that are available in the public domain. The statements produced below are based on the current provisions of Indian law, and the judicial and administrative interpretations thereof, which are subject to change or modification by subsequent legislative, regulatory, administrative or judicial decisions and may not be exhaustive, and are only intended to provide general information to investors and is neither designed nor intended to be a substitute for professional legal advice. We are subject to a number of Central and State legislations which regulate substantive and procedural aspects of the business. Additionally, the business activities of our Company require sanctions, approvals, licenses, registrations etc. from the concerned authorities, under the relevant Central and State legislations and local bye-laws.

For details of Government and Other Approvals obtained by the Company in compliance with the applicable regulations, see “Government and Other Approvals” on page 199 of this Prospectus. The following is an overview of some of the important laws, policies and regulations which are pertinent to our business as a player in the field of real estate developers for commercial purposes.

INDUSTRY SPECIFIC REGULATIONS

National Non-Ferrous Metal Scrap Recycling Framework, 2020

The National Non-Ferrous Metal Scrap Recycling Framework, 2020, as amended (the “Non-Ferrous Metal Recycling Framework”) issued by the Ministry of Mines, Government of India, envisages bringing both product and processing stewardship to enhance Non-Ferrous Metal recycling. Its objectives include, inter alia, promotion of a formal and well organized recycling ecosystem; adoption of data-based analysis and policy making at all stages of the recycling chain; production of high quality scrap for quality secondary production whilst minimizing the dependency on imports; achieving technological leadership in scientific methodology; bettering the quality of scrap produced; and to promote the 6Rs principles of Reduce, Reuse, Recycle, Recover, Redesign and Remanufacture through scientific handling, processing and disposal of all types of non-ferrous scrap, through authorized centres / facility. The Non-Ferrous Metal Recycling Framework aims to achieve its goal of having a sustainable non-ferrous metal recycling eco-system in the long run by, inter alia, setting up a central authority for recycling of metals which may be called as Metal Recycling Authority; placing obligations on the stakeholders involved in the process; setting up an institutional mechanism for carrying out studies and advance research in the field of recycling of metal; and by having the government encourage and provide support to research & development in metal scrap recycling. It also aims to develop specified metal recycling zones with facility for collection, segregation, dismantling etc. of metal scrap and ensure quality control by fixing minimum infrastructure requirement for recycling units with clear minimum standards and criteria for the processing of recyclables to produce consistent, high quality streams of recyclable material.

Central Electricity Authority (Measures relating to Safety and Electric Supply) Regulations, 2010

The Indian Electricity (IE) Rules, 1956 was made under section 37 of the Indian Electricity Act, 1910 and redefined after enactment of The Electricity Act, 2003. CEAR namely Central Electricity Authority (Measures relating to Safety and Electric Supply) Regulations, 2010 came into effect from 20th September 2010, in place of The Indian Electricity Rules, 1956.

The Electrical Wires, Cables, Appliances and Protection Devices and Accessories (Quality Control) Order, 2003 (the “Quality Control Order”)

The Quality Control Order prohibits the manufacture, storage for sale, sale and distribution of electrical wires, cables, appliances, protection devices (including low voltage switchgear and fuses) that do not conform to the standards specified in such order and that do not bear the standard mark issued by the BIS. The Quality Control Order directs a manufacturer of electric wires, cables and protection devices, amongst others, to commence manufacture of such electric equipment only after obtaining a license from the BIS for the use of standard mark. Further, it requires any sub-standard or defective electrical wires, cables, appliances, protection devices or accessories to be deformed by such manufacturer beyond use and disposed of as scrap. The Central Government is authorized to appoint an officer who is empowered to require any person engaged in the manufacture, storage, sale or distribution of electrical equipment to furnish information and samples in relation to the electric equipment manufactured, stored, sold or distributed, as the case may be, inspect any books or documents and search any premises and seize electric equipment in case of contravention of the Quality Control Order

The Factories Act, 1948

The Factories Act defines a ‘factory’ to be any premises including the precincts thereof, on which on any day in the previous 12 months, 10 or more workers are or were working and in which a manufacturing process is being carried on or is ordinarily carried on with the aid of power; or where at least 20 workers are or were working on any day in the preceding 12 months and on which a manufacturing process is being carried on or is ordinarily carried on without the aid of power. State governments prescribe rules with respect to the prior submission of plans, their approval for the establishment of factories and the registration and licensing of factories.

The Factories Act provides that the 'occupier' of a factory (defined as the person who has ultimate control over the affairs of the factory and in the case of a company, any one of the directors) shall ensure the health, safety and welfare of all workers while they are at work in the factory, especially in respect of safety and proper maintenance of the factory such that it does not pose health risks, the safe use, handling, storage and transport of factory articles and substances, provision of adequate instruction, training and supervision to ensure workers' health and safety, cleanliness and safe working conditions.

The Micro, Small and Medium Enterprises Development Act, 2006

In order to promote and enhance the competitiveness of Micro, Small and Medium Enterprise ("MSME") the Micro, Small and Medium Enterprises Development Act, 2006 is enacted. A National Board shall be appointed and established by the Central Government for MSME enterprise with its head office at Delhi in the case of the enterprises engaged in the manufacture or production of goods pertaining to any industry mentioned in first schedule to Industries (Development and Regulation) Act, 1951 as "micro enterprise", where the investment in plant and machinery does not exceed twenty-five lakh rupees, "Small enterprise", where the investment in plant and machinery is more than twenty-five lakh rupees but does not exceed five crore rupees, or a medium enterprise, where the investment in plant and machinery is more than five crore but does not exceed ten crore rupees and in the case of the enterprise engaged in the services, "Micro-enterprise", where the investment in equipment does not exceed ten lakh rupees, "Small Enterprise" where the investment in equipment is more than ten lakh rupees but does not exceed two crore rupees, or "Medium Enterprise" where the investment in equipment is more than two crore rupees but does not exceed five crore rupees.

The Bureau of Indian Standards Act, 2016

The BIS Act provides for the establishment of bureau for the standardization, marking and quality certification of goods. Functions of the bureau include, inter-alia, (a) recognizing as an Indian standard, any standard established by any other institution in India or elsewhere, in relation to any article or process; (b) specifying a standard mark to be called the Bureau of Indian Standards Certification Mark which shall be of such design and contain such particulars as may be prescribed to represent a particular Indian standard; and (c), make an inspection and take such samples of any material or substance as may be necessary to see whether any article or process in relation to which the standard mark has been used conforms to the Indian Standard or whether the standard mark has been improperly used in relation to any article or process with or without a license.

The Legal Metrology Act, 2009

An act to establish and enforce standards of weights and measures, regulate trade and commerce in weights, measures and other goods which are sold or distributed by weight, measure or number and for matters incidental thereto The part of metrology in relation to weighing and measuring units as well as methods of weighing and measuring instruments with the object of ensuring public guarantee and from the point of view of security and accuracy of weighing and measurement. Any weight or measure which conforms to the standard of such weight or measure and also conforms to such of the provisions of Sec 7 as are applicable to it shall be the standard of weight or measure. Any numeral which conforms to the provisions of Sec 6 shall be the standard numeral. It further provides that no weight, measure or numeral, other than the standard weight, measure or numeral shall be used as a standard weight, measure or numeral. No person shall manufacture, repair or sell, or offer, expose or possess for repair or sale, any weight or measure unless he holds a license issued by the Controller. No license to repair shall be required by a manufacturer for repair of his own weight or measure in State other than the State of manufacture of the same. The Controller shall issue a license in such form and runner on such conditions, for such period and such area of jurisdiction and on payment of such fee as may be prescribed.

The Digital Personal Data Protection Act, 2023 ("DPDP ACT")

The DPDP Act was notified on August 11, 2023 and is yet to come into effect. It replaces the existing data protection provision, as contained in Section 43A of the IT Act. The DPDP Act shall come into force on such date as the Central Government may, by notification in the Official Gazette, appoint and different dates may be appointed for different provisions of the DPDP Act. The DPDP Act seeks to balance the rights of individuals to protect their digital personal data with the need to process personal data for lawful and other incidental purposes. The DPDP Act provides that personal data may be processed only for a lawful purpose after obtaining the consent of the individual. A notice must be given before seeking consent, except in case of legitimate uses as provided under the DPDP Act. It further imposes certain obligations on data fiduciaries including (i) make reasonable efforts to ensure the accuracy and completeness of data, (ii) build reasonable security safeguards to prevent a data breach, (iii) inform the Data Protection Board of India (the "DPB") and affected persons in the event of a breach, and (iv) erase personal data as soon as the purpose has been met and retention is not necessary for legal purposes (storage limitation). In case of government entities, storage limitation and the right of the data principal to erasure will not apply. The DPDP Act imposes certain additional obligations on a significant data fiduciary, such as appointment of a data protection officer, appointment of an independent data auditor and undertaking of other measures namely, periodic data protection impact assessment, periodic audit and such other measures as may be prescribed under the DPDP Act. The Central Government will establish the DPB. Key functions of the DPB include: (i) monitoring compliance and imposing penalties, (ii) directing data fiduciaries to take necessary measures in the event of a data breach, and (iii) hearing grievances made by affected persons. The DPB members will be appointed for two years and will be eligible for re-appointment. The Central Government will prescribe details such as the number of members of the DPB and the selection process.

Standards Of Weights and Measures Act, 1976

The Standards of Weights and Measures Act, 1976 (the “Act”) was enacted to regulate trade or commerce in weights, measures and other goods which are sold or distributed by weight, measure or number and to provide for such matters as may be connected thereto. The Act enumerates the specific base units to measure goods and products. Any offence under this Act is punishable with imprisonment or fine or with both based on the type of violation.

Prevention Of Black Marketing and Maintenance of Supplies Act, 1980

The Prevention of Black Marketing and Maintenance of Supplies Act is an Act for detention in certain cases for the purpose of prevention of black marketing and maintenance of supplies of commodities essential to the community and for matters concerned therewith.

LAWS RELATING TO SPECIFIC STATE WHERE THE ESTABLISHMENT IS SITUATED

Gujarat Industrial Policy, 2020

Gujarat is the most industrialized state in India and has been recognized nationally and globally for offering conducive business ecosystem that is supported by ease of doing business and state-of-the-art infrastructure. The state has witnessed unprecedented growth in terms of investments, both FDI and domestic. With a vision to give additional thrust to “Atmanirbhar Bharat”, the New Gujarat Industrial Policy 2020 is being introduced with added focus on key thrust sectors, strengthening integrated value chains, innovation and research. Besides this, the Gujarat Industrial Policy has provisions to promote industries focusing to adopt sustainable & cleaner manufacturing and innovative Industry 4.0 practices. It also lays objective to encourage entrepreneurship and strengthen MSMEs and facilitate cluster development.

‘Make in India’ initiative launched by Government of India aims at enhancing manufacturing through investment, innovation and best-in-class infrastructure. Gujarat has been successfully contributing to the initiative’s objective of transforming India into a global design and manufacturing hub supported by conducive infrastructure and ease of doing business. The State Government has also introduced notable reforms in order to create a conducive business environment in the state.

The initiative ZED (Zero Defect in Manufacturing and Zero Effect to Environment) was launched to enhance the quality of the manufactured goods with the end goal of positioning India as the “World’s Manufacturing Hub”. Gujarat’s manufacturing sector has imbibed ZED as a core pillar which has supported the Gujarat MSMEs carve a niche for themselves in the global supply chain.

Gujarat Industrial Policy 2020 is offering land on lease, de-linking of incentives from tax structure and replacing it with capital subsidy without any upper ceiling will attract many a soul to take the entrepreneurial path. Gujarat Industrial Policy 2020 spearheads balanced regional development and is the torchbearer for inclusive growth.

The Gujarat Shops and Establishments (Regulation Of Employment And Conditions Of Service) Act, 2019

The Gujarat Shops and Establishments (Regulation of Employment and Conditions of service) Act, 2019 is a state law that regulates the working conditions and rights of workers employed in shops and other establishments in Gujarat. The act covers various aspects such as hours of work, overtime, leave, holidays, wages, health, safety, welfare, etc. The act also provides for the registration of shops and establishments with the authorities and the maintenance of records and registers. Section 6 of the act requires every employer to apply for the registration of his establishment within sixty days from the date of commencement of the act or the date on which the establishment commences its work, whichever is later. The employer has to furnish the prescribed particulars and fees along with the application. The registration certificate is valid for a period of ten years and can be renewed thereafter.

The Gujarat State Tax on Professions, Trades, Callings and Employments Act, 1976

The Gujarat State Tax on Professions, Trades, Callings and Employments Act, 1976 is a state law that imposes a tax on the income earned by persons engaged in various professions, trades, callings and employments in Gujarat. The tax is levied according to the rates and slabs specified in Schedule I of the act. The act also provides for the registration and enrolment of the persons liable to pay the tax. Every employer who is liable to deduct and pay tax on behalf of his employees has to obtain a registration certificate and an enrollment certificate from the prescribed authority within 60 days of the commencement of the act or the date of becoming liable to pay tax, whichever is later.

The Gujarat Electricity Duty Act, 1958

The Gujarat Electricity Duty Act, 1958 is an act that imposes a duty on the consumption or sale of electricity in the state of Gujarat. The act was enacted to provide for the revenue of the state from the use of electrical energy. The act defines various terms such as consumer, energy, industrial undertaking, etc. and provides for different rates and exemptions of the duty depending on the purpose and category of the consumer. The act also empowers the state government to grant certificates of exemption to certain industrial undertakings that meet the prescribed criteria and conditions. Such industrial undertakings can apply for the certificate in the prescribed form and manner to the designated officer and obtain the exemption from the payment of electricity duty for a specified

period. The act also lays down the procedure for the assessment, collection and recovery of the duty and the penalties for the evasion or non-payment of the duty.

Gujarat Fire Prevention and Life Safety Measures Act, 2013

The state legislatures have also enacted fire control and safety rules and regulations such as the Gujarat Fire Prevention and Life Safety Measures Act, 2013 and its Rules and Regulation, which is applicable to our manufacturing units. The legislation includes provisions in relation to provision of fire safety and life saving measures by occupiers of buildings, licensing provisions and penalties for non-compliance.

LABOUR RELATED LEGISLATIONS

Minimum Wages Act, 1948

The Minimum Wages Act, 1948 came into force with an objective to provide for the fixation of a minimum wage payable by the employer to the employee. Every employer is mandated to pay the minimum wages to all employees engaged to do any work skilled, unskilled, and manual or clerical (including out-workers) in any employment listed in the schedule to this Act, in respect of which minimum rates of wages have been fixed or revised under the Act.

Payment Of Wages Act, 1936

The Payment of Wages Act, 1936 as amended (the Payment of Wages Act) has been enacted to regulate the payment of wages in a particular form at regular intervals without unauthorized deductions and to ensure a speedy and effective remedy to employees against illegal deductions and / or unjustified delay caused in paying wages. It applies to the persons employed in a factory, industrial or other establishment, whether directly or indirectly, through a sub-contractor and provides for the imposition of fines and deductions and lays down wage periods. The Payment of Wages Act is applicable to factories and industrial or other establishments where the monthly wages payable are less than Rs. 6,500 per month.

Industrial Disputes Act, 1947

The Industrial Disputes Act, 1947 (Industrial Disputes Act) provides for mechanism and procedure to secure industrial peace and harmony by investigation and settlement of industrial disputes by negotiations. The Industrial Disputes Act extends to whole of India and applies to every industrial establishment carrying on any business, trade, manufacture or distribution of goods and services irrespective of the number of workmen employed therein. Every person employed in an establishment for hire or reward including contract labour, apprentices and part time employees to do any manual, clerical, skilled, unskilled, technical, operational or supervisory work, is covered by the Act. The Act also provides for (a) the provision for payment of compensation to the Workman on account of closure or layoff or retrenchment. (b) the procedure for prior permission of appropriate Government for laying off or retrenching the workers or closing down industrial establishments (c) restriction on unfair labour practices on part of an employer or a trade union or workers.

Contract Labour (Regulation and Abolition) Act, 1970, as Amended (THE “CLRA ACT”)

The Contract Labour (Regulation and Abolition) Act, of 1970 (the “CLRA Act”) requires a company to be registered as a principal employer and prescribes certain obligations with respect to the welfare and health of contract labourers. The CLRA vests responsibility in the principal employer of an establishment, to which the CLRA applies, to make an application to the concerned officer for registration of the concerned establishment. In the absence of such registration, contract labour cannot be employed in the concerned establishment. Likewise, every contractor, to whom the CLRA applies, is required to obtain a license and may not undertake or execute any work through contract labour except under and in accordance with the license issued. To ensure the welfare and health of the contract labour, the CLRA imposes certain obligations on the contractor in relation to the establishment of canteens restrooms, drinking water, washing facilities, first aid, other facilities and payment of wages. However, in the event the contractor fails to provide these amenities, the principal employer is under an obligation to provide these facilities within a prescribed time period. Penalties, including both fines and imprisonment, may be levied for contravention of the provisions of the CLRA.

Equal Remuneration Act, 1976

The Equal Remuneration Act, 1976, as amended (ER Act) provides for the payment of equal remuneration to men and women workers for same or similar nature of work and prevention of discrimination, on the ground of sex, against women in the matter of employment and for matters connected therewith or incidental thereto. Under the ER Act, no discrimination is permissible in recruitment and service conditions, except where employment of women is prohibited or restricted by law. It also provides that every employer should maintain such registers and other documents in relation to the workers employed by him/ her in the prescribed manner.

Employees’ State Insurance Act, 1948

It Employees’ State Insurance Act to provide for certain benefits to employees in case of sickness, maternity and employment injury and to make provision for certain other matters in relation thereto. Whereas it is expedient to provide for certain benefits to employees

in case of sickness, maternity and employment injury and to make provision for certain other matters in relation thereto; this Act requires all the employees of the establishment to which this act applies to be insured to the manner provided there under. The Employer and Employees both are required to make contribution to the fund. The return of the contribution made is required to be filed with the Employee State Insurance department.

Employees' Provident Funds and Miscellaneous Provisions Act, 1952 ("EPF ACT")

The EPF Act applies to factories employing over 20 employees and such other establishments and industrial undertakings as notified by the Government of India from time to time. It requires all such establishments to be registered with the State provident fund commissioner and requires such employers and their employees to contribute in equal proportion to the employees' provident fund the prescribed percentage of basic wages and dearness and other allowances payable to employees. The EPF Act also requires the employer to maintain registers and submit a monthly return to the State provident fund commissioner.

Inter-State Migrant Workmen (Regulation of Employment and Conditions Of Service) Act, 1979

Inter-State Migrant Workmen Act is an act enacted by the Parliament of India to regulate the employment of inter-state migrant workmen and to provide for their conditions of service. This Act is applicable to every establishment and contractor who has employed five or more inter-state of Pass-Book to every inter-state migrant workman with full details, payment of displacement allowance equivalent to 50% of monthly wages of ₹ 75/-, whichever is higher, payment of journey allowance including payment of wage during the period of the journey, suitable residential accommodation, medical facilities and protective clothing, payment of wages, equal pay for equal work irrespective of sex, etc. The main responsibility for the enforcement of the provisions of the Inter-State Migrant Workmen Act lies with the Central Government and the State Governments/Union Territories in the establishments falling in the Central and State sphere, respectively.

Child Labour (Prohibition and Regulation) Act, 1986

This statute prohibits employment of children below 14 years of age in certain occupations and processes and provides for regulation of employment of children in all other occupations and processes. Under this Act the employment of child labour in the building and construction industry is prohibited.

Payment of Bonus Act, 1965

The Payment of Bonus Act, 1965 is applicable to every establishment employing 20 or more employees. The said Act provides for payment of the minimum bonus specified under the Act to the employees. It further requires the maintenance of certain books and registers such as the register showing computation of the allocable surplus; the register showing the set on & set off of the allocable surplus and register showing the details of the amount of Bonus due to the employees. Further it also require for the submission of Annual Return in the prescribed form (FORM D) to be submitted by the employer within 30 days of payment of the bonus to the Inspector appointed under the Act.

Minimum Wages Act, 1948

The Minimum Wages Act, 1948 came into force with an objective to provide for the fixation of a minimum wage payable by the employer to the employee. Every employer is mandated to pay the minimum wages to all employees engaged to do any work skilled, unskilled, and manual or clerical (including out-workers) in any employment listed in the schedule to this Act, in respect of which minimum rates of wages have been fixed or revised under the Act.

Maternity Benefit Act, 1961

The Maternity Benefit Act, 1961, as amended regulates the employment of pregnant women and ensures that they get paid leave for a specified period during and after their pregnancy. The Maternity Benefit Act is applicable to establishments in which 10 or more employees are employed, or were employed on any day of the preceding 12 months. Under the Maternity Benefit Act, a mandatory period of leave and benefits should be granted to female employees who have worked in the establishment for a minimum period of 80 days in the preceding 12 months from the date of her expected delivery. Such benefits essentially include payment of average daily wage for the period of actual absence of the female employee. The maximum period for which any woman shall be entitled to maternity benefit shall be 12 weeks, of which not more than six weeks shall precede the date of her.

Workmen's Compensation Act, 1923

The Workmen Compensation Act, 1923 has been enacted with the objective to provide for the payment of compensation to workmen by employers for injuries by accident arising out of and in the course of employment, and for occupational diseases resulting in death or disablement. The WCA makes every employer liable to pay compensation in accordance with the WCA if a personal injury/disablement/loss of life is caused to a workman (including those employed through a contractor) by accident arising out of and in the course of his employment. In case the employer fails to pay compensation due under the WCA within one month from the date it falls due, the commissioner appointed under the WCA may direct the employer to pay the compensation amount along with interest and may also impose a penalty.

Sexual Harassment at Workplace (Prevention, Prohibition And Redressal) Act, 2013

The Sexual Harassment at Workplace (Prevention, Prohibition and Redressal) Act, 2013 (SHWPPR Act) provides for protection against sexual harassment at the workplace to women and prevention and redressal of complaints of sexual harassment. The SHWPPR Act defines Sexual Harassment to include any unwelcome sexually determined behaviour (whether directly or by implication). Workplace under the SHWPPR Act has been defined widely to include government bodies, private and public sector organizations, non-governmental organizations, organizations carrying on commercial, vocational, educational, entertainment, industrial, financial activities, hospitals and nursing homes, educational institutes, sports institutions and stadiums used for training individuals. The SHWPPR Act requires an employer to set up an Internal Complaints Committee at each office or branch, of an organization employing at least 10 employees. The Government in turn is required to set up a Local Complaint Committee at the district level to investigate complaints regarding sexual harassment from establishments where our internal complaints committee has not been constituted.

The Code on Social Security, 2020

The Code on Social Security, 2020 received the assent of the President of India on September 28, 2020 and it proposes to subsume certain existing legislations including the Employee's Compensation Act, 1923, the Employees' State Insurance Act, 1948, the Employees' Provident Funds and Miscellaneous Provisions Act, 1952, the Maternity Benefit Act, 1961, the Payment of Gratuity Act, 1972, the Building and Other Construction Workers' Welfare Cess Act, 1996 and the un-organized Workers' Social Security Act, 2008. The provisions of this code will be brought into force on a date to be notified by the Central Government. In addition to above, we are subject to wide variety of generally applicable labour laws concerning condition of working, benefit and welfare of our labourers and employees such as the Sexual Harassment of Women at Workplace (Prevention, Prohibition and Redressal) Act, 2013 and the Employees (Provident Fund and Miscellaneous Provision) Act, 1952.

TAX RELATED LEGISLATIONS

Income Tax Act, 1961

Income Tax Act, 1961 is applicable to every Domestic / Foreign Company whose income is taxable under the provisions of this Act or Rules made under it depending upon its Residential Status and-Type of Income involved. U/s 139(1) every Company is required to file its Income tax return for every Previous Year by 30th September of the Assessment Year. Other compliances like those relating to Tax Deduction at Source, Fringe Benefit Tax, Advance Tax, and Minimum Alternative Tax like are also required to be complied by every Company.

Goods And Service Tax, 2017

Goods and Services Tax (GST) is levied on supply of goods or services or both jointly by the Central and State Governments. It was introduced as The Constitution (One Hundred and First Amendment) Act 2017 and is governed by the GST Council. GST provides for imposition of tax on the supply of goods or services and will be levied by central on intra-state supply of goods or services and by the States including Union territories with legislature/ Union Territories without legislature respectively. A destination based consumption tax GST would be a dual GST with the central and states simultaneously levying tax with a common base. The GST law is enforced by various acts viz. Central Goods and Services Act, 2017 (CGST), State Goods and Services Tax Act, 2017 (SGST), Union Territory Goods and Services Tax Act, 2017 (UTGST), Integrated Goods and Services Tax Act, 2017 (IGST) and Goods and Services Tax (Compensation to States) Act, 2017 and various rules made thereunder.

Every person liable to take registration under these Acts shall do so within a period of 30 days from the date on which he becomes liable to registration. The Central/State authority shall issue the registration certificate upon receipt of application. The Certificate shall contain fifteen digit registration numbers known as Goods and Service Tax Identification Number (GSTIN). In case a person has multiple business verticals in multiple locations in a state, a separate application will be made for registration of each and every location. The registered assessee is then required to pay GST as per the rules applicable thereon and file the appropriate returns as applicable thereon. GST has replaced following indirect taxes and duties at the central and state levels.

ENVIRONMENT LAWS AND REGULATIONS

The Environmental Protection Act, 1986 ("Environment Protection Act"), Water (Prevention and Control of Pollution) Act, 1974 ("Water Act") and the Air (Prevention and Control of Pollution) Act, 1981 ("Air Act") provide for the prevention, control and abatement of pollution. Pollution Control Boards ("PCBs") have been constituted in all the States in India to exercise the authority provided under these statutes for the purpose of preventing and controlling pollution. Companies are required to obtain approvals of the relevant State PCBs for emissions and discharge of effluents into the environment. **The Hazardous Wastes (Management, Handling and Transboundary Movement) Rules, 2016 ("Hazardous Waste Rules")** impose an obligation on every occupier and operator of a facility generating hazardous waste to dispose of such hazardous wastes properly including proper collection, treatment, storage and disposal. Every occupier and operator of the facility generating hazardous waste is required to obtain an approval from the PCB for collecting, storing and treating the hazardous waste.

E-Waste (Management and Handling), Rules, 2016

Under the E-Waste Rules, a manufacturer is responsible for the collection of E-waste generated during the manufacture of any electrical and electronic equipment and channelize it for recycling or disposal. Further, the E-Waste Rules also require the relevant authorisations must be obtain from state pollution control boards, where manufacturing activities resulting in generation of E-Waste, are carried out.

Plastic Waste Management Rules, 2016

The Plastic Waste rules apply to manufacturers of plastic, users involved in generation of plastic as a raw material as well as individuals and institutions that generate plastic waste. Any entity or institution that generates plastic waste is responsible for segregating and handling the waste in the manner as prescribed under the rules. Further, the Plastic Waste Rules seek to minimize and regulation of plastic and ensure proper collection and disposal of plastic waste.

The Noise Pollution (Regulation & Control) Rules, 2000 (“Noise Regulation Rules”)

The Noise Regulation Rules regulate noise levels in industrial, commercial and residential zones. The Noise Regulation Rules also establish zones of silence of not less than 100 meters near schools, courts, hospitals, etc. The rules also assign regulatory authority for these standards to the local district courts. Penalty for non-compliance with the Noise Regulation Rules shall be under the provisions of the Environment Act.

IMPORT-EXPORT REGULATIONS

Foreign Direct Investment Policy, 2020

The Foreign Direct Investment (FDI) Policy aims to attract and promote foreign investment to supplement domestic resources for accelerated economic growth. FDI is subject to compliance with relevant sectoral laws, regulations, security conditions, and state/local laws. The Consolidated FDI Policy 2020, issued by the Department for Promotion of Industry and Internal Trade (DPIIT), establishes guidelines for FDI inflows into India. It is updated annually to align with regulatory changes.

Foreign Trade (Development and Regulation) Act, 1992

Foreign Trade Act empowers the Government of India to, among other things, (a) make provisions for development and regulation of foreign trade; (b) prohibit, restrict or otherwise regulate exports and imports; (c) formulate an EXIM policy; and (d) appoint a Director General of Foreign Trade for the purpose of administering foreign trade and advising the Central Government in formulating EXIM policy and implementing the same. Every importer and exporter is required to obtain an ‘Importer Exporter Code’ from the Director General of Foreign Trade or from any other duly authorized officer.

Foreign Trade Policy

The Foreign Trade Policy provides that no export or import can be made by a person without an IEC unless such person is specifically exempted. The policy provides for all exports and imports made shall be governed by the Foreign Trade Policy, unless otherwise specified. FTP provides for handbook of procedures laying down the procedure to be followed by an exporter or importer or by any Licensing/Regional Authority or by any other authority for purposes of implementing provisions of FT (D&R) Act, the Rules and the Orders made there under and provisions of FTP.

Foreign Exchange Management Act, 1999 (“FEMA”) and Regulations Framed Thereunder

Foreign investment in India is governed primarily by the provisions of the FEMA which relates to regulation primarily by the RBI and the rules, regulations and notifications there under, and the policy prescribed by the Department of Promotion of Industry and Internal Trade. As laid down by the FEMA Regulations no prior consents and approvals are required from the Reserve Bank of India, for Foreign Direct Investment under the ‘automatic route’ within the specified sectoral caps. In respect of all industries not specified as FDI under the automatic route, and in respect of investment in excess of the specified sectoral limits under the automatic route, approval may be required from the FIPB and/or the RBI. The RBI, in exercise of its power under the FEMA, has notified the Foreign Exchange Management (Transfer or Issue of Security by a Person Resident Outside India) Regulations, 2000 (“FEMA Regulations”), as amended from time to time to prohibit, restrict or regulate, transfer by or issue security to a person resident outside India and Foreign Exchange Management (Export of Goods and Services) Regulations, 2000 for regulation on exports of goods and services.

GENERAL STATUTORY LEGISLATIONS

Companies Act, 2013 (“Companies Act”)

The Companies Act, 2013, has replaced the Companies Act, 1956 in a phased manner. The Act received the assent of President of India on 29th August 2013. The Companies Act deals with incorporation of companies and the procedure for incorporation and post incorporation. The conversion of private company into public company and vice versa is also laid down under the Companies Act, 2013. The procedure related to appointment of Directors. The procedure relating to winding up, voluntary winding up, appointment of liquidator also forms part of the Act. Further, Schedule V (read with sections 196 and 197), Part I lays down the conditions to be fulfilled for the appointment of a managing or whole-time director or manager. It provides the list of Acts under which if a person is

prosecuted, he cannot be appointed as the director or Managing Director or Manager of a Company. The provisions relating to remuneration of the director's payable by the companies is under Part II of the said schedule.

Competition Act, 2002

The Competition Act, 2002 prohibits anti-competitive agreements, abuse of dominant positions by enterprises and regulates combinations in India. The Competition Act also established the Competition Commission of India (the —CCI) as the authority mandated to implement the Competition Act. The provisions of the Competition Act relating to combinations were notified recently on March 4, 2011 and came into effect on June 1, 2011. Combinations which are Likely to cause an appreciable adverse effect on competition in a relevant market in India are void under the Competition Act. A combination is defined under Section 5 of the Competition Act as an acquisition, merger or amalgamation of enterprise(s) that meets certain asset or turnover thresholds. There are also different thresholds for those categorized as Individuals and Group. The CCI may enquire into all combinations, even if taking place outside India, or between parties outside India, if such combination is Likely to have an appreciable adverse effect on competition in India. Effective June 1, 2011, all combinations have to be notified to the CCI within 30 days of the execution of any agreement or other document for any acquisition of assets, shares, voting rights or control of an enterprise under Section 5(a) and (b) of the Competition Act (including any binding document conveying an agreement or decision to acquire control, shares, voting rights or assets of an enterprise); or the board of directors of a company (or an equivalent authority in case of other entities approving a proposal for a merger or amalgamation under Section 5(c) of the Competition Act. The obligation to notify a combination to the CCI falls upon the acquirer in case of an acquisition, and on all parties to the combination jointly in case of a merger or amalgamation.

Indian Contract Act, 1872

The Contract Act is the legislation which lays down the general principles relating to formation, performance and enforceability of contracts. The rights and duties of parties and the specific terms of agreement are decided by the contracting parties themselves, under the general principles set forth in the Contract Act. The Contract Act also provides for circumstances under which contracts will be considered as 'void' or 'voidable'. The Contract Act contains provisions governing certain special contracts, including indemnity, guarantee, bailment, pledge, and agency.

Specific Relief Act, 1963

The Specific Relief Act, 1963 is complimentary to the provisions of the Contract Act and the Transfer of Property Act, as the Act applies both to movable property and immovable property. The Act applies in cases where the Court can order specific performance of a contract. Specific relief can be granted only for purpose of enforcing individual civil rights and not for the mere purpose of enforcing a civil law. Specific performance means Court will order the party to perform his part of agreement, instead of imposing on him any monetary liability to pay damages to other party.

Sale of Goods Act, 1930

The law relating to the sale of goods is codified in the Sale of Goods Act, 1930. It defines sale and agreement to sell as a contract whereby the seller transfers or agrees to transfer the property in goods to the buyer for a price and provides that there may be a contract of sale between part owner and another and that the contract of sale may be absolute or conditional.

Public Liability Insurance Act, 1991 ("PLI ACT")

The PLI Act imposes liability on the owner or controller of hazardous substances for any damage arising out of an accident involving such hazardous substances. The government by way of a notification has enumerated a list of hazardous substances. The owner or handler is also required to obtain an insurance policy insuring against liability under the legislation. The rules made under the PLI Act mandate that the owner shall contribute towards the environmental relief fund a sum equal to the premium paid on the insurance policies. The amount is payable to the insurer.

Consumer Protection Act, 2019 ("Consumer Protection Act") and Rules Made Thereunder

The Consumer Protection Act was designed and enacted to provide simpler and quicker access to redress consumer grievances. It seeks, amongst other things, to promote and protects the interests of consumers against deficiencies and defects in goods or services and secure the rights of a consumer against unfair trade practices, which may be practiced by manufacturers, service providers and traders. The definition of "consumer" under the Consumer Protection Act includes persons engaged in offline or online transactions through electronic means or by tele-shopping or direct-selling or multi-level marketing. It provides for the establishment of consumer disputes redressal forums and commissions for the purposes of redressal of consumer grievances. In addition to awarding compensation and/or passing corrective orders, the forums and commissions under the Consumer Protection Act, in cases of misleading and false advertisements, are empowered to impose imprisonment for a term which may extend to two years and fine which may extend to ten lakhs.

In line with the Consumer Protection Act, the Ministry of Consumer Affairs, Food and Public Distribution, Government of India ("Ministry of Consumer Affairs") has also notified the Consumer Protection (E-Commerce) Rules, 2020 ("E-Commerce Rules") on

July 23, 2020, which provide a framework to regulate the marketing, sale and purchase of goods and services online. The E-Commerce Rules govern e-commerce entities which own, operate, or manage, a digital or electronic facility or platform for electronic commerce, but does not include a seller offering his goods or services for sale on a marketplace e-commerce entity. The Ministry of Consumer Affairs has also released draft amendments to the E-Commerce Rules for public comments. The aforesaid draft amendments require e-commerce entities to, amongst other things, register themselves with the Department for Promotion of Industry and Internal Trade, and appoint a chief compliance officer, a nodal contact person and a resident grievance officer. Additionally, the draft amendments prohibit e-commerce entities from misleading users by manipulating search results, prohibit flash sales and abuse of dominant position, and mandate e-commerce entities to identify sponsored listings of products and services with clear and prominent disclosures.

Code of Civil Procedure, 1908

The Code of Civil Procedure, 1908 is a procedural law related to the administration of civil proceedings in India. The Civil Procedure Code consolidates and amends the law relating to the procedure of the Courts of Civil jurisdiction. The Code of Civil Procedure is an adjective law it neither creates nor takes away any right. It is intended to regulate the procedure to be followed by Civil Courts. The Civil Procedure Code consists of two parts. 158 Sections form the first part and the rules and orders contained in Schedule I form the second part. The object of the Code generally is to create jurisdiction while the rules indicate the mode in which the jurisdiction should be exercised.

The Code does not affect any special or local laws nor does it supersede any special jurisdiction or power conferred or any special form of procedure prescribed by or under any other law for the time being in force. The Code is the general law so that in case of conflict between the Code and the special law the latter prevails over the former. Where the special law is silent on a particular matter the Code applies, but consistent with the special enactment.

Code of Criminal Procedure Code, 1973

It is the main legislation on procedure for administration of substantive criminal law in India. It was enacted in 1973 and came into force on 1st April, 1974. It provides the machinery for the investigation of crime, apprehension of suspected criminals, collection of evidence, determination of guilt or innocence of the accused person and the determination of punishment of the guilty.

Criminal law occupies a pre-dominant place among the agencies of social control and is regarded as a formidable weapon that society has forged to protect itself against anti-social behaviour. The law of criminal procedure is meant to be complimentary to criminal law. It is intended to provide a mechanism for the enforcement of criminal law. The Code of Criminal Procedure creates the necessary machinery for apprehending the criminals, investigating the criminal cases, their trials before the criminal courts and imposition of proper punishment on the guilty person. The Code enumerates the hierarchy of criminal courts in which different offences can be tried and then it spells out the limits of sentences which such Courts are authorized to pass.

The law of criminal procedure is intended to provide a mechanism for the enforcement of criminal law. Without the proper procedural law the substantive criminal law which defines offences and provides punishment for them would be almost worthless.

Arbitration and Conciliation Act, 1996

The Arbitration and Conciliation Act, 1996 is an act to consolidate and amend the law relating to domestic arbitration, international commercial arbitration and enforcement of foreign arbitral awards as also to define the law relating to conciliation and for matters connected therewith or incidental thereto. It aims at streamlining the process of arbitration and facilitating conciliation in business matters. The Act recognizes the autonomy of parties in the conduct of arbitral proceedings by the arbitral tribunal and abolishes the scope of judicial review of the award and minimizes the supervisory role of Courts. A significant feature of the Act is the appointment of arbitrators by the Chief Justice of India or Chief Justice of High Court. The Chief Justice may either appoint the arbitrator himself or nominate a person or Institution to nominate the arbitrator. The autonomy of the arbitral tribunal has further been strengthened by empowering them to decide on jurisdiction and to consider objections regarding the existence or validity of the arbitration agreement.

Negotiable Instruments Act, 1881

In India, cheques are governed by the Negotiable Instruments Act, 1881, which is largely a codification of the English Law on the subject. The Act provides effective legal provision to restrain people from issuing cheques without having sufficient funds in their account or any stringent provision to punish them in the event of such cheque not being honoured by their bankers and returned unpaid. Section 138 of the Act, creates statutory offence in the matter of dishonour of cheques on the ground of insufficiency of funds in the account maintained by a person with the banker which is punishable with imprisonment for a term which may extend to two year, or with fine which may extend to twice the amount of the cheque, or with both.

Indian Stamp Act, 1899

Under the Indian Stamp Act, 1899 (the "Stamp Act") stamp duty is payable on instruments evidencing a transfer or creation or extinguishment of any right, title or interest in immovable property. Stamp duty must be paid on all instruments specified under the

Stamp Act at the rates specified in the schedules to the Stamp Act. The applicable rates for stamp duty on instruments chargeable with duty vary from state to state. Instruments chargeable to duty under the Stamp Act, which are not duly stamped are incapable of being admitted in court as evidence of the transaction contained therein and it also provides for impounding of instruments that are not sufficiently stamped or not stamped at all

INTELLECTUAL PROPERTY RELATED LEGISLATIONS

Trade Marks Act, 1999 (“Trade Marks Act”)

The Trade Marks Act governs the statutory protection of trademarks and prevention of the use of fraudulent marks in India. It provides for the application and registration of trademarks in India. It also provides for exclusive rights to marks such as brand, label, and heading and to obtain relief in case of infringement for commercial purposes as a trade description. Under the provisions of the Trade Marks Act, an application for trade mark registration may be made with the Controller General of Patents, Designs and Trademarks by any person or persons claiming to be the proprietor of a trade mark, whether individually or as joint applicants, and can be made on the basis of either actual use or intention to use a trade mark in the future. Once granted, a trade mark registration is valid for 10 years unless cancelled, subsequent to which, it can be renewed. If not renewed, the mark lapses and the registration is required to be restored to gain protection under the provisions of the Trade Marks Act. The Trade Marks Act prohibits registration of deceptively similar trademarks and provides penalties for infringement, falsifying or falsely applying for trademarks. Further, pursuant to the notification of the Trade Marks (Amendment) Act, 2010, simultaneous protection of trade mark in India and other countries has been made available to owners of Indian and foreign trade marks. It also seeks to simplify the law relating to the transfer of ownership of trade marks by assignment or transmission and to bring the law in line with international practices.

Copyright Act, 1957

Copyright is a right given by the law to creators of literary, dramatic, musical and artistic works and producers of cinematograph films and sound recordings. In fact, it is a bundle of rights including, inter alia, and rights of reproduction, communication to the public, adaptation and translation of the work. There could be slight variations in the composition of the rights depending on the work.

The Patents Act, 1970 (“Patents Act”)

The Patents Act governs the patent regime in India. India is a signatory to the Trade Related Agreement on Intellectual Property Rights and recognizes both product as well as process patents. The Patents Act provides for, inter alia, the following:

- Patent protection period of 20 years from the date of filing the patent application;
- Recognition of product patents in respect of food, medicine and drugs;
- Import of patented products will not be considered as an infringement; and
- Under certain circumstances, the burden of proof in case of infringement of process patents may be transferred to the alleged infringer.

The Design Act, 2000

The Design Act, which came into force in May 2001, along with the rules made thereunder consolidate and amend the law relating to protection of designs. A design refers to the features of shape, configuration, pattern, ornamentation or composition of lines or colours applied to any article, in two or three dimensional or both forms, by an industrial process or means, whether manual, mechanical or chemical, separate or combined which in the finished article appeal to and is judged solely by the eye. In order to register a design, it must be new or original and must not be disclosed to the public anywhere in India or any other country by publication in tangible form or by use or in any other way prior to the filing date. A design should be significantly distinguishable from known designs or combination of known designs in order for it to be registered. A registered design is valid for a period of 10 years after which the same can be renewed for a second period of five years, before the expiration of the original period of 10 years. After such period, the design is made available to the public by placing it in the public domain.

OTHER LAWS

Municipality Laws

Pursuant to the Seventy Fourth Amendment Act, 1992, the respective State Legislatures in India have the power to endow the Municipalities (as defined under Article 243Q of the Constitution of India) with the power to implement schemes and perform functions in relation to matters listed in the Twelfth Schedule to the Constitution of India which includes regulation of public health. The respective States of India have enacted laws empowering the Municipalities to regulate public health including the issuance of a health trade license for operating eating outlets and implementation of regulations relating to such license along with prescribing penalties for non-compliance.

Police Laws

The State Legislatures in India are empowered to enact laws in relation to public order and police under Entries 1 and 2 of the State List (List II) to the Constitution of India. Pursuant to the same the respective States of India have enacted laws regulating the same along with prescribing penalties for non-compliance.

HISTORY AND CORPORATE STRUCTURE

Brief history of our Company:

Our company was originally formed as partnership firm under the Indian Partnership Act, 1932 (“Partnership Act”) in the name and style of “M/s. Sunlite Industries, pursuant to a deed of partnership entered between Prahladrai Ramdayal Heda, Nitin Kumar Heda and Khushboo Manishkumar Heda executed on dated September 28, 2017 on the terms and conditions contained in the said partnership deed. Later on, “M/s Sunlite Industries” was thereafter converted from partnership firm to a private limited Company under part I Chapter XXI of Section 366 of the Companies Act, 2013 with the name and style of “Sunlite Alucop Private Limited” and received a certificate of incorporation dated August 04, 2022 issued by the Registrar of Companies, Central Registration Centre bearing Corporate Identification Number U27200GJ2022PTC134540. Further, pursuant to Special Resolution passed by the shareholders at the Extra Ordinary General Meeting held on January 12, 2024, the name of our Company was changed from “Sunlite Alucop Private Limited” to “Sunlite Recycling Industries Private Limited” and a fresh certificate of incorporation consequent upon change of name was issued by the Registrar of Companies, Ahmedabad vide letter dated January 18, 2024. Subsequently, our Company was converted into a Public Limited Company vide Special Resolution passed by the Shareholders at the Extra Ordinary General Meeting, held on February 10, 2024 and consequently the name of our Company was changed from “Sunlite Recycling Industries Private Limited” to “Sunlite Recycling Industries Limited” vide a fresh certificate of incorporation consequent upon conversion from private company to public company dated April 30, 2024 issued by the Registrar of Companies, Central Processing Centre. Our Company’s Corporate Identity Number is U27200GJ2022PLC134540.

Nitin Kumar Heda, Prahladrai Ramdayal Heda and Khushboo Manishkumar Heda were the initial subscribers to the Memorandum and Articles of Association of our Company.

The details in this regard have been disclosed in the chapter titled “*Capital Structure*” beginning on page 59 of this Prospectus.

For information on our Company’s profile, activities, products, market, growth, technology, managerial competence, standing with reference to prominent competitors, major Vendors and suppliers, please refer the sections titled “*Our Business*”, “*Industry Overview*”, “*Our Management*”, “*Financial information of the Company*” and “*Management’s Discussion and Analysis of Financial Condition and Results of Operations*” on pages 98, 86, 125, 144 and 185 respectively of this Prospectus.

Our Locations:

Registered Office & Manufacturing Unit	Survey No. 270A & Plot No. 1, Survey No. 267, Chhatha Mile, Dantali, Vaso, Kheda -387350, Gujarat, India.
Marketing Office	Office No. 905, 9th floor, Millennium Empire, Sector 15, Panvel, Navi Mumbai – 410210, Maharashtra, India.

Changes in the Registered Office of the Company since Incorporation:

There has not been any change in our Registered Office since inception till the date of the Prospectus.

Main Objects of our Company as per the Memorandum of Association:

The main objects of our Company, as set forth in our Memorandum of Association of our Company are as follows:

- To carry on the business as manufacturers, re-cyclers, assemblers, producers, processors, fabricators, collectors, contractors, importers, exporters, stockiest, agents, dealers, distributors, smelters, refiners, finishers, buyers or sellers or in any other capacity in india or elsewhere, of all kinds and classes of ferrous & non-ferrous metals including but not limited to various types of metals such as copper, copper continuous rod, oxygen free copper rods, fire-refined high conductivity copper rods, bars, rods, copper wire, copper earthing wires, copper conductor, copper submersible wires, copper stripes, plates, sheets, utensils, vessels, copper wire drawing etc., iron and steel, aluminum, tin, nickel, zinc, lead, brass, silicon scrap and their products & alloys, pipes, wire drawing of any metal and minor metals such as antimony, cadmium, bismuth, mercury magnesium, chrome metal and rolling works; and produce all types of dies, mould, jigs, bearings, fixtures, nuts, screws, pumps, rollers cases, shafts, lathes, grinders, axes, spades, and other tools casting of all description and types, whether of steel, iron, copper, bronze, lead, zinc, aluminium, or any other ferrous or non-ferrous metal or alloys.
- To act as broker, importer, exporter, buyer, seller, stockists, distributor, contractor, supplier, metallurgists, engineer, collaborator, job worker, or otherwise deal in alloys, metal, waste, scrap, foils, powders, flakes, strips, sheets, wires made up of steel or copper or anyother material whether coated, uncoated, perforated, printed, embossed and produce all types of sections, varieties, strengths, specifications, descriptions, dimensions, and shapes of steel products, including bars, angles, tubes, pipes and blanks thereof, hollow bars, containers, stranded wires, cables, cordage, ropes, plaited bands, electrodes &

PVC insulated electric wires with brand name of 1.Sunkab Wires & Cables, 2.Sunkab Super Wires & Cables & 3.Sinflex Wires & Cables, and to do all incidental acts and things necessary for the attainment of the above objects.

3. To carry on business to manufacture, produce, process, excavate, quarry, melt, mould, roll, commercialize, cold, clean, cure, treat, mix and manipulate alloy, special steels, stainless steel, cold and hot rolled steel, all types of materials required for manufacture of alloy, tool and special steels, steel casting fabricating, smelting, rolling and forging, steel and alloy steel billets and all kinds and sizes of rerolled sections, i.e., flats angles, rounds, T. Iron, squares, hexagons, octagons, rails, joints, channels, steel strips, sheets, plates, deformed bars, plain and cold twisted bars, bright bars, shaftings and steel structure.
4. To acquire/ purchase/ take over the business as a going concern with name, trademark and goodwill from M/s. Sunlite Industries, Gujarat, a Partnership firm carrying on the business as per the objects mentioned in clause(s) 1 to 3 and to carry on such business undertaken by them on such terms and conditions as mutually agreed upon including such takeover, without in any manner affecting the arrangements and agreements entered by the vendors (i.e. M/s. Sunlite Industries, Gujarat) with Government, Govt & Semi Govt. Organisations, Banks, Channel Partners such as Distributors, Advertisers and Advg. Agencies, Sales Agents, Consultants, Suppliers or their representatives or any other business organisations but actually stepping into the shoes of the Vendors with regard to all such agreements between the Vendors and other parties mentioned above, with regard to these publications.

Changes/Amendments to the Memorandum of Association:

Except as stated below there has been no change in the Memorandum of Association of our Company since its Incorporation:

Date of Meeting	Type of Meeting	Nature of Amendments
January 12, 2024	EGM	Clause I of the Memorandum of Association was amended to reflect change in name from “Sunlite Alucop Private Limited” to “Sunlite Recycling Industries Private Limited” and a fresh certificate of incorporation consequent upon change of name was issued by the Registrar of Companies, Ahmedabad vide letter dated January 18, 2024.
January 16, 2024	EGM	Alteration in Clause V by increase in the authorized share capital of the Company from ₹50.00 Lakhs divided into 5,00,000 Equity Shares of ₹10/- each to ₹1200.00 Lakhs divided into 1,20,00,000 Equity Shares of ₹10/- each.
February 10, 2024	EGM	Conversion of our Company from Private Limited to Public Limited Company. Consequently, name of the Company was changed from “Sunlite Recycling Industries Private Limited” to “Sunlite Recycling Industries Limited” vide a fresh certificate of incorporation consequent upon conversion of Company to Public Limited dated April 30, 2024 was issued by the Registrar of Companies, Central Processing Centre, bearing Corporate Identification Number U27200GJ2022PLC134540.
May 06, 2024	EGM	<p>The existing Sub Clause 1 of clause III(A) of the main objects of the Company was deleted and substituted with the following new Sub Clause 1 as under:</p> <ol style="list-style-type: none"> 1. To carry on the business as manufacturers, re-cyclers, assemblers, producers, processors, fabricators, collectors, contractors, importers, exporters, stockiest, agents, dealers, distributors, smelters, refiners, finishers, buyers or sellers or in any other capacity in india or elsewhere, of all kinds and classes of ferrous & non-ferrous metals including but not limited to various types of metals such as copper, copper continuous rod, oxygen free copper rods, fire-refined high conductivity copper rods, bars, rods, copper wire, copper earthing wires, copper conductor, copper submersible wires, copper stripes, plates, sheets, utensils, vessels, copper wire drawing etc., iron and steel, aluminum, tin, nickel, zinc, lead, brass, silicon scrap and their products & alloys, pipes, wire drawing of any metal and minor metals such as antimony, cadmium, bismuth, mercury magnesium, chrome metal and rolling works; and produce all types of dies, mould, jigs, bearings, fixtures, nuts, screws, pumps, rollers cases, shafts, lathes, grinders, axes, spades, and other tools casting of all description and types, whether of steel, iron, copper, bronze, lead, zinc, aluminium, or any other ferrous or non-ferrous metal or alloys.

Major Key Events, Milestone and Achievements of our Company:

The Table below sets forth some of the major events in the history of our company:

Effective Date/F.Y.	Key Events / Milestone / Achievements
September 28, 2017	Established Partnership firm in the name of “M/s. Sunlite Industries”.
October 28, 2017	Partnership firm was registered as on October 28, 2017 having registration number GUJVA200549.
August 04, 2022	Conversion from the partnership firm into a Private Limited Company in the name of “Sunlite Alucop Private Limited”.
FY 2022-23	Crossed Revenue of ₹1000 crores
January 18, 2024	Change in the name of our Company from “Sunlite Alucop Private Limited” to “Sunlite Recycling Industries Private Limited”
April 30, 2024	Conversion of Company from Private Limited Company into Public Limited Company.

Other details about our Company:

For details of our Company’s activities, products, growth, awards & recognitions, capacity, locations, technology, marketing strategy, competition and our customers, please refer section titled “*Our Business*”, “*Management’s Discussion and Analysis of Financial Conditions and Results of Operations*” and “*Basis for Issue Price*” on pages 98, 185 and 77 respectively of this Prospectus. For details of our management and managerial competence and for details of shareholding of our Promoters, please refer to sections titled “*Our Management*” and “*Capital Structure*” beginning on page 125 and 59 of the Prospectus respectively.

Capital Raising (Debt / Equity):

For details in relation to our capital raising activities through equity, please refer to the chapter titled “*Capital Structure*” beginning on page 59 of the Prospectus. For details of our Company’s debt facilities, see “*Statement of Financial Indebtedness*” on page 182 of the Prospectus.

Changes in activities of our Company during the last five (5) Years:

There has not been any change in the activity of our Company during the last five (5) years preceding the date of this Prospectus.

Our Holding Company:

As on the date of the Prospectus, our Company is not a subsidiary of any company.

Our Subsidiary Company

As on the date of this Prospectus, Our Company does not have any Subsidiary Company.

Our Associates Company:

Our Company does not have any Associate Company as on the date of this Prospectus.

Joint Ventures:

The Company has not formed any joint ventures as on the date of this Prospectus.

Details regarding material acquisitions or divestments of business/ undertakings, mergers, amalgamation, any revaluation of assets etc., if any, in the last ten years.

Except as disclosed in this Prospectus, our Company has not made any material acquisitions or divestments of any business or undertakings, mergers, amalgamation or revaluation of assets in the last 10 years preceding the date of this Red Herring Prospectus.

Injunction or Restraining Order:

Except as disclosed in the section titled “*Outstanding Litigation and Material Developments*” beginning on page 195 of this Prospectus, there are no injunctions/restraining orders that have been passed against the Company.

Number of shareholders of our Company:

Our Company has 7 (Seven) shareholders as on the date of this Prospectus. For further details on the shareholding pattern of our Company, please refer to the chapter titled “*Capital Structure*” beginning on page 59 of the Prospectus.

Changes in the Management:

For details of change in Management, please see chapter titled “*Our Management*” on page 125 of the Prospectus.

Agreement with key managerial personnel or Directors or Promoters or any other employee of the Company:

There are no agreements entered into by key managerial personnel or Directors or Promoters or any other employee, either by themselves or on behalf of any other person, with any shareholder or any other third party with regard to compensation or profit sharing in connection with dealings in the securities of the Company.

Shareholders Agreements:

There are no subsisting shareholder’s agreements among our shareholders in relation to our Company, to which our Company is a party or otherwise has notice of the same as on the date of the Prospectus.

Collaboration Agreements:

As on date of this Prospectus, Our Company is not a party to any collaboration agreements.

Material Agreement:

Our Company has not entered into any subsisting material agreements including with strategic partners, joint venture partners and/or financial partners, entered into, other than in the ordinary course of business of the Company.

Strategic or Financial Partners:

Except as disclosed in this Prospectus, Our Company does not have any strategic or financial partners as on the date of this Prospectus.

Time and Cost Overruns in Setting up Projects:

There has been no time / cost overrun in setting up projects by our Company.

Defaults or Rescheduling of Borrowings with Financial Institutions/Banks:

There have been no defaults or rescheduling of borrowings with any financial institutions/banks as on the date of the Prospectus.

Other Agreements:

i. Non-Compete Agreement:

Our Company has not entered into any No- compete Agreement as on the date of filing of this Prospectus.

ii. Joint Venture Agreement:

Our Company has not entered into any Joint Venture Agreement as on the date of filing of this Prospectus.

OUR MANAGEMENT**Board of Directors:**

The following table sets forth the details regarding the Board of Directors of our Company as on the date of filing of this Prospectus:

Name, Designation, Age, Date of Birth, Address, Experience, Occupation, Qualification, Current term, Period of Directorship and DIN	Other directorships
<p>Nitin Kumar Heda Designation: Managing Director Age: 36 years Date of Birth: October 01, 1987 Address: 7 Mangal Murti Society, Petlad Road, Nadiad, Kheda 387002, Gujarat, India. Experience: 17 years Occupation: Business Qualification: Bachelor of Commerce (B.Com.) Current Term: Change in designation as Managing Director of the Company for a period of 5 years, w.e.f. May 01, 2024 Period of Directorship: since incorporation DIN: 00383855</p>	<ul style="list-style-type: none"> Santram Metals And Alloys Private Limited
<p>Prahladrai Ramdayal Heda Designation: Chairman & Whole Time Director Age: 64 years Date of Birth: February 05, 1960 Address: 62 Prime Flora, Near Santram Deri, Nadiad, Kheda 387002, Gujarat, India. Experience: 15 years Occupation: Business Qualification: Qualified Eight (VIIIth) Standard Current Term: Change in designation as Chairman & Whole Time Director of the Company for a period of 5 years, w.e.f. May 01, 2024 Period of Directorship: since incorporation DIN: 09696242</p>	<ul style="list-style-type: none"> Heda Sanghatan Seva Foundation
<p>Khushboo Manishkumar Heda Designation: Non-Executive Director Age: 35 years Date of Birth: February 05, 1989 Address: 7 Mangal Murti Society, Petlad Road, Nadiad, Kheda 387002, Gujarat, India. Experience: 6 years Occupation: Business Qualification: Master of Business Administration Current Term: Change in designation as Non-Executive Director of the Company w.e.f. September 15, 2022 Period of Directorship: since incorporation DIN: 09696263</p>	<p style="text-align: center;">Nil</p>
<p>Ronak Ashokbhai Mehta Designation: Independent Director Age: 32 years Date of Birth: January 27, 1992 Address: D-503 ICB Flora, Behind Vodafone Tower, Gota, Daskroi, Ahmedabad 382481, Gujarat, India. Experience: More than 3 years Occupation: Business</p>	<ul style="list-style-type: none"> Maruti Infrastructure Limited

<p>Qualification: Practicing Company Secretary Current Term: Appointed for a term upto 5 years, w.e.f. May 01, 2024 and shall not be liable to retire by rotation Period of Directorship: w.e.f. May 01, 2024 DIN: 10525257</p>	
<p>Jaimish Govindbhai Patel Designation: Independent Director Age: 35 years Date of Birth: February 05, 1989 Address: 412-2306, Gujarat Housing Board Nr, Navarang Flat, Bapunagar, Ahmedabad City – 380024, Gujarat, India. Experience: More than 8 years Occupation: Employment Qualification: Company Secretary Current Term: Appointed for a term upto 5 years, w.e.f. May 01, 2024 and shall not be liable to retire by rotation Period of Directorship: w.e.f. May 01, 2024 DIN: 09647742</p>	<ul style="list-style-type: none"> • Baheti Recycling Industries Limited • Kaka Industries Limited • Siyaram Recycling Industries Limited

Brief Profile of Directors:

1. **Nitin Kumar Heda**, is Promoter and Managing Director of our Company. He has been on the Board of Directors of the Company since incorporation. He holds a bachelor’s degree in commerce from University of Delhi. He has a work experience of more than 17 years in the field of copper manufacturing Industry. He is playing vital role in formulating business strategies and effective implementation of the same. He is responsible for the business development, Legal operations & Compliance and overall management of the business of our Company.
2. **Prahladrai Ramdayal Heda**, is Promoter and Chairman & Whole Time Director of our Company. He has been on the Board of Directors of the Company since incorporation. He has passed Eight (VIIIth) Standard from Rajkiya Senior Uch Madhyamik Vidyalaya, Kapasan, chittorgarh in 2008. He has a work experience of more than 15 years in the field of copper manufacturing Industry. He is responsible for general business and administration functions in our Company.
3. **Khushboo Manishkumar Heda**, is Promoter and Non-Executive Director of our Company. She has been on the Board of Directors of the Company since incorporation. She holds a Master’s degree in Master of Business Administration from Sikkim Manipal University, Gangtok, Sikkim in 2012. She has a work experience of 6 years in the field of copper manufacturing Industry. She is responsible for general business and administration functions in our Company.
4. **Ronak Ashokbhai Mehta**, is the Independent Director of our Company. He has a work experience of more than 3 years in Corporate Laws and Financial Management. He is a Qualified Member of the Institute of Company Secretaries of India.
5. **Jaimish Govindbhai Patel** is the Independent Director of our Company. He has a work experience of more than 8 years in Legal & Regulatory compliances, Corporate Governance, Corporate Laws and Financial Management. He is a Qualified Member of the Institute of Company Secretaries of India.

Confirmations:

As on the date of this Prospectus:

- a) None of our Directors is or was a director of any listed company during the last five years preceding the date of this Prospectus, whose shares have been or were suspended from being traded on the BSE or the NSE, during the term of their directorship in such company.
- b) None of our Directors is or was a director of any listed company which has been or was delisted from any stock exchange during the tenure of their directorship in such company.
- c) None of our Directors are categorized as a wilful defaulter or a fraudulent borrower, as defined under Regulation 2(1)(III) of SEBI (ICDR) Regulation 2018 .
- d) None of our Directors are fugitive economic offender as defined under Regulation 2(1)(p) of SEBI (ICDR) Regulation 2018.

- e) None of our Directors have been debarred from accessing capital markets by the Securities and Exchange Board of India. Additionally, none of our directors are or were, associated with any other company which is debarred from accessing the capital market by the Securities and Exchange Board of India.

Arrangements with major Shareholders, Customers, Suppliers or Others:

We have not entered into any arrangement or understanding with our major shareholders, customers, suppliers or others, pursuant to which any of our Directors were selected as Director or member of the senior management.

Service Contracts:

The Directors of our Company have not entered into any service contracts with our company which provides for benefits upon termination of their employment.

Details of Borrowing Powers of Directors

Pursuant to a special resolution passed at an Extra Ordinary General Meeting of our Company held on May 06, 2024 and pursuant to provisions of Section 180(1)(c) and other applicable provisions, if any, of the Companies Act, 2013 and rules made thereunder, the Board of Directors of the Company have been authorized to borrow monies from time to time, any sum or sums of money on such security and on such terms and conditions as the Board may deem fit, notwithstanding that the money to be borrowed together with the money already borrowed by our Company may exceed in the aggregate, its paid up capital and free reserves and security premium (apart from temporary loans obtained / to be obtained from bankers in the ordinary course of business), provided that the outstanding principal amount of such borrowing at any point of time shall not exceed in the aggregate of ₹100 crores (Rupees One Hundred Crores Only).

Compensation of our Managing Director & Whole-time Directors

The compensation payable to our Managing Director and Whole-time Directors will be governed as per the terms of their appointment and shall be subject to the provisions of Sections 2(54), 2(94), 188, 196, 197, 198 and 203 and any other applicable provisions, if any of the Companies Act, 2013 read with Schedule V to the Companies Act, 2013 and the rules made there under (including any statutory modification(s) or re-enactment thereof or any of the provisions of the Companies Act, 1956, for the time being in force).

The following compensation has been approved for Managing Director & Whole time Director:

Nitin Kumar Heda: Managing Director

Pursuant to the resolutions passed by our Board and our Shareholders on May 01, 2024 and May 06, 2024 respectively, Nitin Kumar Heda was change in designation as Managing Director for a period of five years with effect from May 01, 2024 at a remuneration of Rs. 10,00,000/- per month, which includes, basic salary, dearness allowance, perquisites and other allowances or any other combination thereof.

Prahladrai Ramdayal Heda: Chairman & Whole Time Director

Pursuant to the resolutions passed by our Board and our Shareholders on May 01, 2024 and May 06, 2024 respectively, Prahladrai Ramdayal Heda was change in designation as Chairman & Whole Time Director for a period of five years with effect from May 01, 2024 at a remuneration of Rs. 4,00,000/- per month, which includes, basic salary, dearness allowance, perquisites and other allowances or any other combination thereof.

Payments or benefits to Directors:

The remuneration/ Compensation paid to our Directors:

Except mentioned below, no other current directors have received remuneration during the Fiscal year 2023:

Name of Directors	Amount (Rs. in lakhs)
Nitin Kumar Heda	66.00
Prahladrai Ramdayal Heda	22.00

Bonus or Profit-Sharing plan for our Directors:

We have no bonus or profit sharing plan for our Directors.

Sitting Fees:

Pursuant to the provision of section 197(5) of the Companies Act, 2013 read with the rule 4 of Companies (Appointment and Remuneration of Managerial Personnel) Rules, 2014, the remuneration payable in terms of sitting fees to the Directors (including Independent Directors) of the Company, such sum as may be decided by the Board of Directors which shall not exceed ₹1,00,000/- (Rupees One Lakh Only) per meeting of the Board or Committee thereof. Our Board of Directors have resolved in their meeting dated May 08, 2024 for payment of an amount of ₹5,000 (Rupees Five Thousand Only) each for attending the Board Meeting and ₹3,000 (Rupees Three Thousand Only) each for attending Committee meeting thereof, attended by such director.

In Fiscal 2023, our Company has not paid any compensation or granted any benefit on an individual basis to any of our directors (including contingent or deferred compensation) other than the sitting fees and/or commission paid to them for such period.

Shareholding of our Directors as on the date of this Prospectus: -

Sr. No.	Name of the Directors	No. of Shares held	Holding in %
1.	Nitin Kumar Heda	39,99,800	50.00
2.	Prahladrai Ramdayal Heda	19,99,900	25.00
3.	Khushboo Manishkumar Heda	19,99,900	25.00
	Total	79,99,600	100.00

None of the Independent Directors of the Company holds any Equity Shares of Company as on the date of this Prospectus.

We do not have Subsidiary Company as defined under Section 2(87) of the Companies Act, 2013.

Our Articles of Association do not require our Directors to hold any qualification Equity Shares in the Company.

INTEREST OF DIRECTORS

All the Directors may be deemed to be interested to the extent of remuneration and reimbursement of expenses payable to them under the Articles, and to the extent of remuneration paid to them for services rendered as an officer or employee of the Company. For further details, please refer to Chapter titled **"Our Management"** beginning on page 125 of this Prospectus.

Our Directors may also be regarded as interested to the extent of their shareholding and dividend payable thereon, if any, and to the extent of Equity Shares, if any held by them in our Company or held by their relatives. Further our Directors are also interested to the extent of unsecured loans, if any, given by them to our Company or by their relatives or by the companies/ firms in which they are interested as directors/Members/Partners. Further our Directors are also interested to the extent of loans, if any, taken by them or their relatives or taken by the companies/ firms in which they are interested as Directors/Members/Partners and for the details of Personal Guarantee given by the Directors towards Financial facilities of our Company please refer to **"Statement of Financial Indebtedness"** on page 182 of this Prospectus.

Except as stated otherwise in this Prospectus, our Company has not entered into any Contract, Agreements or Arrangements during the preceding two years from the date of this Prospectus in which the Directors are interested directly or indirectly and no payments have been made to them in respect of the contracts, agreements or arrangements which are proposed to be entered into with them. Except as stated in this section **"Our Management"** or the section titled **"Financial information of the Company –Annexure - J- Related Party Disclosure"** beginning on page 125 and 176 respectively of this Prospectus, and except to the extent of shareholding in our Company, our Directors do not have any other interest in our business.

Interest in the property of Our Company:

Except as mentioned hereunder, Our Directors do not have any interest in any property acquired/rented by our Company in a period of two years before filing of this Prospectus or proposed to be acquired by us as on date of this Prospectus.

Sr. No.	Name of Director	Address of Property	Interest and nature of interest
1.	Nitin Kumar Heda	Survey No. 270A & Plot No. 1 Survey No. 267, Chhatha Mile, Dantali, Vaso, Kheda - 387350, Gujarat, India.	The said property has been obtained on rent from Nitin Kumar Heda vide rent agreement dated February 06, 2024 for a period of 11 months at a rent of Rs. 1,40,000 p.m. w.e.f. February 01, 2024.

Changes in Board of Directors in last 3 Years

Except as mentioned hereunder, there is no change in Board of Directors of the Company in last 3 years: -

Sr. No.	Name of Directors	Date of Appointment / Re- appointment/ Change in designation/ Cessation	Reasons for Change
1.	Khushboo Manishkumar Heda	Change in designation as as Non-Executive Director w.e.f. September 15, 2022.	To ensure better Corporate Governance
2.	Nitin Kumar Heda	Appointed as Director w.e.f August 04, 2022. Further, Change in designation as Managing Director w.e.f. May 01, 2024.	
3.	Prahldrai Ramdayal Heda	Appointed as Director w.e.f August 04, 2022. Further, Change in designation as Chairman & Whole Time Director w.e.f. May 01, 2024.	
4.	Ronak Ashokbhai Mehta	Appointed as Additional Independent Director w.e.f. May 01, 2024.and regularized as Independent Director in the EGM dated May 06, 2024.	
5.	Jaimish Govindbhai Patel	Appointed as Additional Independent Director w.e.f. May 01, 2024.and regularized as Independent Director in the EGM dated May 06, 2024.	

MANAGEMENT ORGANISATION STRUCTURE

The following chart depicts our Management Organization Structure: -

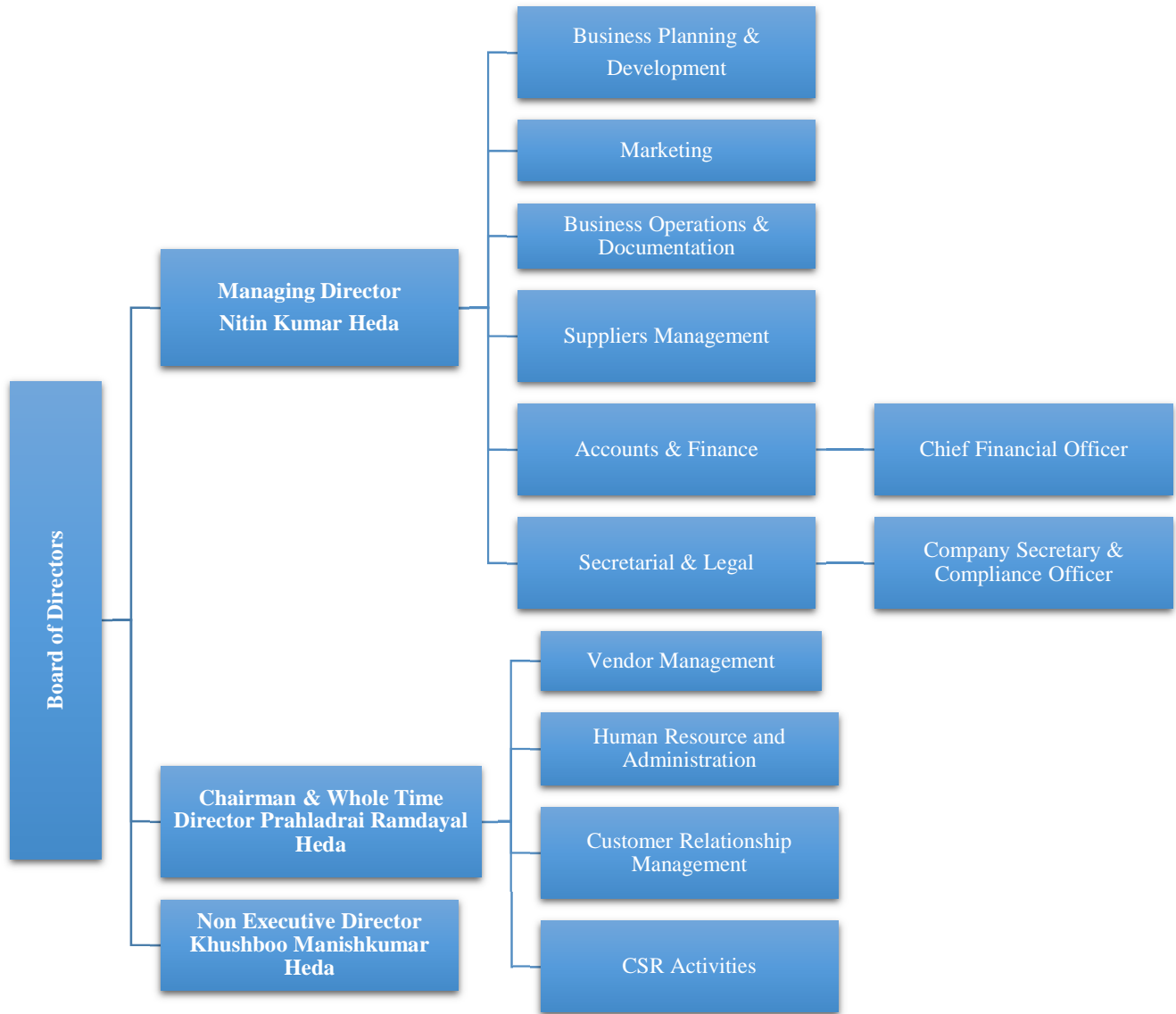

COMPLIANCE WITH CORPORATE GOVERNANCE

In addition to the applicable provisions of the Companies Act, 2013, provisions of the SEBI (Listing Obligations and Disclosure Requirements) Regulations, 2015 as amended and SEBI (ICDR) Regulations, 2018 in respect of corporate governance will be applicable to our Company immediately upon the listing of our Company's Equity Shares on Stock Exchanges. We are in compliance with the requirements of corporate governance with respect to composition of Board and constitution of the committees of the Board, including the Audit Committee, Nomination and Remuneration Committee, Stakeholder Relationship Committee and Corporate Social Responsibility Committee, by our Company and formulation and adoption of policies, as prescribed under the SEBI Listing Regulations. Our Board undertakes to take all necessary steps to continue to comply with all the requirements of Listing Regulations and the Companies Act, 2013.

Our Board has been constituted in compliance with the Companies Act, the SEBI (LODR) Regulations. The Board of Directors function either as a full board or through various committees constituted to oversee specific operational areas.

Our Board of Directors consist of five (5) Directors of which two (2) are Independent Directors, and we have one women directors on the Board. In compliance with Section 152 of the Companies Act, 2013, not less than two thirds of the Directors (excluding Independent Directors) are liable to retire by rotation.

Committees of the Board:

The Board of Directors functions either as a full board or through various committees constituted to oversee specific operational areas. In addition to the Committees detailed below, our Board of Directors may, from time to time constitute Committees for various functions.

Details of the Committees as on the date of this Prospectus are set forth below

1. Audit Committee

Our Company at its Board Meeting held on May 08, 2024 has constituted an Audit Committee ("Audit Committee") in compliance with the provisions of the Section 177 of the Companies Act, 2013 read with rule 6 of the companies (Meeting of board and its power) rules, 2014 and Regulation 18 of Securities and Exchange Board of India (Listing Obligations and Disclosure Requirements) Regulations, 2015. The constituted Audit Committee comprises following members:

Name of the Directors	Status in Committee	Nature of Directorship
Jaimish Govindbhai Patel	Chairman	Independent Director
Ronak Ashokbhai Mehta	Member	Independent Director
Nitin Kumar Heda	Member	Managing Director

The Company Secretary of the Company shall act as a Secretary to the Audit Committee. The scope and function of the Audit Committee and its terms of reference shall include the following:

A. Tenure:

The Audit Committee shall continue to be in function as a committee of the Board until otherwise resolved by the Board, to carry out the functions of the Audit Committee as approved by the Board.

B. Meetings of the Committee:

The committee shall meet at least four times in a year and not more than one hundred and twenty days shall elapse between any two meetings. The quorum for the meeting shall be either two members or one third of the members of the committee, whichever is higher. The Chairman of the Audit Committee shall attend the Annual General Meeting of the Company to furnish clarifications to the shareholders on any matter relating to accounts.

C. Role and Powers:

The Role of Audit Committee together with its powers as per Part C of Schedule II of SEBI Listing Regulation, 2015 and Companies Act, 2013 shall be as under:

The Audit Committee shall have powers, including the following:

- a) to investigate any activity within its terms of reference;
- b) to seek information from any employee;
- c) to obtain outside legal or other professional advice;

- d) to secure attendance of outsiders with relevant expertise, if it considers necessary as may be prescribed under the Companies Act, 2013 (together with the rules thereunder) and SEBI Listing Regulations; and
- e) To have full access to information contained in records of Company.

The role of the Audit Committee shall include the following:

- 1) oversight the Company's financial reporting process and disclosure of its financial information to ensure that its financial statements are correct, sufficient and credible;
- 2) Recommending to the Board for the appointment, re-appointment, replacement, remuneration and terms of appointment of the statutory auditors of the Company;
- 3) Reviewing and monitoring the statutory auditor's independence and performance, and effectiveness of audit process;
- 4) Approving payments to the statutory auditors for any other services rendered by the statutory auditors;
- 5) Reviewing, with the management, the annual financial statements and auditor's report thereon before submission to the Board for approval, with particular reference to:
 - a. Matters required to be included in the Director's Responsibility Statement to be included in the Board's report in terms of clause (c) of sub-section 3 of Section 134 of the Companies Act;
 - b. Changes, if any, in accounting policies and practices and reasons for the same;
 - c. Major accounting entries involving estimates based on the exercise of judgment by management;
 - d. Significant adjustments made in the financial statements arising out of audit findings;
 - e. Compliance with listing and other legal requirements relating to financial statements;
 - f. Disclosure of any related party transactions; and
 - g. Qualifications and modified opinions in the draft audit report.
- 6) Reviewing, with the management, the quarterly, half-yearly and annual financial statements before submission to the Board for approval;
- 7) Reviewing, with the management, the statement of uses/ application of funds raised through an issue (public issue, rights issue, preferential issue, etc.), the statement of funds utilized for purposes other than those stated in the offer document/ prospectus/ notice and the report submitted by the monitoring agency monitoring the utilization of proceeds of a public or rights issue, and making appropriate recommendations to the Board to take up steps in this matter. This also includes monitoring the use/application of the funds raised through the proposed initial public offer by the Company;
- 8) Approval or any subsequent modifications of transactions of the Company with related parties and omnibus approval for related party transactions proposed to be entered into by the Company subject to such conditions as may be prescribed;
- 9) Scrutiny of inter-corporate loans and investments;
- 10) Valuation of undertakings or assets of the Company, wherever it is necessary;
- 11) Evaluation of internal financial controls and risk management systems;
- 12) Establishing a vigil mechanism for directors and employees to report their genuine concerns or grievances;
- 13) Reviewing, with the management, the performance of statutory and internal auditors, and adequacy of the internal control systems;
- 14) Reviewing the adequacy of internal audit function if any, including the structure of the internal audit department, staffing and seniority of the official heading the department, reporting structure coverage and frequency of internal audit;
- 15) Discussing with internal auditors on any significant findings and follow up thereon;
- 16) Reviewing the findings of any internal investigations by the internal auditors into matters where there is suspected fraud or irregularity or a failure of internal control systems of a material nature and reporting the matter to the Board;
- 17) Discussing with statutory auditors before the audit commences, about the nature and scope of audit as well as post-audit discussion to ascertain any area of concern;
- 18) Looking into the reasons for substantial defaults in the payment to the depositors, debenture holders, shareholders (in case of non-payment of declared dividends) and creditors;
- 19) Reviewing the functioning of the whistle blower mechanism;
- 20) Approving the appointment of the chief financial officer or any other person heading the finance function or discharging that function after assessing the qualifications, experience and background, etc. of the candidate;
- 21) Reviewing the utilization of loans and/ or advances from/investment by the holding company in any subsidiary exceeding ₹1,000 million or 10% of the asset size of the subsidiary, whichever is lower including existing loans / advances / investments;
- 22) Considering and commenting on the rationale, cost-benefits and impact of schemes involving merger, demerger, amalgamation etc., on the Company and its shareholders;
- 23) Such roles as may be delegated by the Board and/or prescribed under the Companies Act, 2013 and SEBI Listing Regulations or other applicable law; and
- 24) Carrying out any other functions as is mentioned in the terms of reference of the audit committee or containing into SEBI (LODR) Regulations 2015.

Further, the Audit Committee shall mandatorily review the following information:

- 1) Management discussion and analysis of financial condition and results of operations;
- 2) Statement of significant related party transactions (as defined by the audit committee), submitted by management;
- 3) Management letters / letters of internal control weaknesses issued by the statutory auditors;

- 4) Internal audit reports relating to internal control weaknesses;
- 5) The appointment, removal and terms of remuneration of the chief internal auditor shall be subject to review by the audit committee; and
- 6) Statement of deviations:
 - a. quarterly statement of deviation(s) including report of monitoring agency, if applicable, submitted to stock exchange(s) in terms of Regulation 32(1) of the SEBI ICDR Regulations;
 - b. Annual statement of funds utilized for purposes other than those stated in the offer document/prospectus/notice in terms of Regulation 32(7) of the SEBI ICDR Regulations.

2. Nomination and Remuneration Committee

Our Company at its Board Meeting held on May 08, 2024 has constituted the Nomination and Remuneration Committee in compliance with the provisions of Section 178, Schedule V and all other applicable provisions of the Companies Act, 2013 read with Rule 6 of the Companies (Meetings of Board and its Power) Rules, 2014 and Regulation 19 of Securities and Exchange Board of India (Listing Obligations and Disclosure Requirements) Regulations, 2015. The constituted Nomination and Remuneration Committee comprises following members:

Name of the Directors	Status in Committee	Nature of Directorship
Jaimish Govindbhai Patel	Chairman	Independent Director
Ronak Ashokbhai Mehta	Member	Independent Director
Khushboo Manishkumar Heda	Member	Non-Executive Director

The scope and function of the Committee and its terms of reference shall include the following:

A. Tenure:

The Nomination and Remuneration Committee shall continue to be in function as a committee of the Board until otherwise resolved by the Board.

B. Meetings:

The committee shall meet as and when the need arises, subject to at least one meeting in a year. The quorum for the meeting shall be either two members or one third of the members of the committee, whichever is greater, including at least one independent director in attendance. The Chairperson of the nomination and remuneration committee may be present at the annual general meeting, to answer the shareholders' queries; however, it shall be up to the chairperson to decide who shall answer the queries.

C. Scope and terms of reference:

The terms of reference of the Nomination and Remuneration Committee as per Regulation 19 and Part D of Schedule II of SEBI Listing Regulations and Companies Act, 2013 shall be as under:

- 1) Formulating the criteria for determining qualifications, positive attributes and independence of a director and recommend to the Board a policy relating to the remuneration of the directors, key managerial personnel and other employees;
- 2) For the appointment of an independent director, the committee shall evaluate the balance of skills, knowledge and experience on the Board and on the basis of such evaluation, prepare a description of the role and capabilities required of an independent director. The person recommended to the board of directors of the Company for appointment as an independent director shall have the capabilities identified in such description. For the purpose of identifying suitable candidates, the Committee may:
 - a. use the services of external agencies, if required;
 - b. consider candidates from a wide range of backgrounds, having due regard to diversity; and
 - c. Consider the time commitments of the candidates.
- 3) Formulation of criteria for evaluation of the performance of independent directors and the Board;
- 4) Devising a policy on diversity of our Board;
- 5) Identifying persons, who are qualified to become directors or who may be appointed in senior management in accordance with the criteria laid down, recommending to the Board their appointment and removal and carrying out evaluation of every director's performance;
- 6) Determining whether to extend or continue the term of appointment of the independent director, on the basis of the report of performance evaluation of independent directors;
- 7) Recommending remuneration of executive directors and any increase therein from time to time within the limit approved by the members of our Company;
- 8) Recommending remuneration to non-executive directors in the form of sitting fees for attending meetings of the Board and its committees, remuneration for other services, commission on profits;
- 9) Recommending to the Board, all remuneration, in whatever form, payable to senior management;
- 10) Performing such functions as are required to be performed by the compensation committee under the SEBI (Share Based

- Employee Benefits and Sweat Equity) Regulations, 2021, as amended;
- 11) Engaging the services of any consultant/professional or other agency for the purpose of recommending compensation structure/policy;
 - 12) Analyzing, monitoring and reviewing various human resource and compensation matters;
 - 13) Reviewing and approving compensation strategy from time to time in the context of the then current Indian market in accordance with applicable laws;
 - 14) Framing suitable policies and systems to ensure that there is no violation, by an employee of any applicable laws in India or overseas, including:
 - a. The SEBI (Prohibition of Insider Trading) Regulations, 2015, as amended; or
 - b. The SEBI (Prohibition of Fraudulent and Unfair Trade Practices relating to the Securities Market) Regulations, 2003, as amended; and
 - 15) Performing such other functions as may be delegated by the Board and/or prescribed under the SEBI Listing Regulations, Companies Act, each as amended or other applicable law.

3. Stakeholders Relationship Committee

Our Company at its Board Meeting held on May 08, 2024 has approved the constitution of the Stakeholders Relationship Committee in compliance with the provisions of the Section 178(5) and all other applicable provisions of the Companies Act, 2013 read with the Rules framed thereunder and Regulation 20 of Securities and Exchange Board of India (Listing Obligations and Disclosure Requirements) Regulations, 2015. The constituted Stakeholders Relationship Committee comprises the following:

Name of the Directors	Status in Committee	Nature of Directorship
Jaimish Govindbhai Patel	Chairman	Independent Director
Nitin Kumar Heda	Member	Managing Director
Prahladrai Ramdayal Heda	Member	Whole time Director

The scope and function of the Stakeholder Relationship Committee and its terms of reference shall include the following:

A. Tenure:

The Stakeholder Relationship Committee shall continue to be in function as a committee of the Board until otherwise resolved by the Board, to carry out the functions of the Stakeholder Relationship Committee as approved by the Board.

B. Meetings:

The Stakeholder Relationship Committee shall meet at least once in a year, and shall report to the Board on a quarterly basis regarding the status of re-dressal of the complaints received from the shareholders of the Company. The quorum for the meeting shall be one third of the total strength of the committee or two members, whichever is higher. The Chairperson of the Stakeholders Relationship Committee shall be present at the annual general meetings to answer queries of the security holders.

C. Scope and terms of reference:

The terms of reference of the Stakeholders Relationship Committee as per Regulation 20 and Part D of Schedule II of SEBI Listing Regulations, 2015 and Companies Act, 2013 shall be as under:

- 1) Consider and resolve grievances of security holders of the Company, including complaints related to transfer/transmission of shares, non-receipt of annual report, non-receipt of declared dividends, issue of new/duplicate certificates, general meetings, etc.;
- 2) Review of measures taken for effective exercise of voting rights by shareholders;
- 3) Review of adherence to the service standards adopted by the Company in respect of various services being rendered by the Registrar and Share Transfer Agent;
- 4) Review of the various measures and initiatives taken by the Company for reducing the quantum of unclaimed dividends and ensuring timely receipt of dividend warrants/annual reports/statutory notices by the shareholders of the Company;
- 5) Formulation of procedures in line with the statutory guidelines to ensure speedy disposal of various requests received from shareholders from time to time;
- 6) To approve, register, refuse to register transfer or transmission of shares and other securities;
- 7) To issue duplicate share or other security(ies) certificate(s) in lieu of the original share/security(ies) certificate(s) of the Company;
- 8) To approve the transmission of shares or other securities arising as a result of death of the sole/any joint shareholder;
- 9) To dematerialize or rematerialize the issued shares;
- 10) Ensure proper and timely attendance and redressal of investor queries and grievances;
- 11) Carrying out any other functions contained in the Companies Act, 2013 and/or equity listing agreements (if applicable), as and when amended from time to time; and

- 12) To perform such functions as may be delegated by the Board and to further delegate all or any of its power to any other employee(s), officer(s), representative(s), consultant(s), professional(s), or agent(s).
- 13) Such terms of reference as may be prescribed under the Companies Act, 2013 and SEBI Listing Regulations or other applicable law

4. Corporate Social Responsibility Committee

Our company has pursuant to the provisions of Section 135 of the Companies Act 2013 and Schedule VII re-constituted a Corporate Social Responsibility Committee of the Board of Directors vide Resolution dated May 08, 2024. The Corporate Social Responsibility Committee comprises the following:

Name of the Directors	Status in Committee	Nature of Directorship
Nitin Kumar Heda	Chairman	Managing Director
Prahladrai Ramdayal Heda	Member	Whole Time Director
Jaimish Govindbhai Patel	Member	Independent Director

The terms of reference of the CSR Committee include the following:

1. formulate and recommend to the Board, a Corporate Social Responsibility Policy which shall indicate the activities to be undertaken by the company in areas or subject, specified in Schedule VII of the Act;
2. formulate and recommend to the Board, an annual action plan in pursuance of its CSR policy, which shall include the following, namely:
 - a) the list of CSR projects or programmes that are approved to be undertaken in areas or subjects specified in Schedule VII of the Act;
 - b) the manner of execution of such projects or programmes as specified in sub-rule (1) of rule 4;
 - c) the modalities of utilisation of funds and implementation schedules for the projects or programmes;
 - d) monitoring and reporting mechanism for the projects or programmes; and
 - e) details of need and impact assessment, if any, for the projects undertaken by the company;
3. recommend the amount of expenditure to be incurred on the CSR activities; and
4. To Monitor the Corporate Social Responsibility policy of the Company from time to time;
5. To disclose the contents of such a policy in its report and to place it on the company's website;
6. Review and recommend to the Board the Business Responsibility Report and the Annual Report on CSR activities which is required to be included in the Boards' Report of the Company
7. Discharge such duties and functions as indicated in the section 135 of the Companies Act, 2013 and Rules made thereunder from time to time and such other functions as may be delegated to the Committee by the Board from time to time.
8. Take all necessary actions as may be necessary or desirable and also to settle any question or difficulty or doubts that may arise with regards to Corporate Social Responsibility activities/Policy of the Company.

KEY MANAGERIAL PERSONNEL

Our Company is supported by a team of professionals having exposure to various operational aspects of our business. A brief detail about the Key Managerial Personnel of our Company is provided below:

Name, Designation, Educational Qualification & Term of office	Age (Years)	Year of joining	Compensation paid for F.Y. ended 2022-23 (in Rs. Lakh)	Overall experience (in years)	Previous employment
Nitin Kumar Heda Designation: Managing Director Educational Qualification: Bachelor of Commerce Term of office: 5 years w.e.f. May 01, 2024	36	2022	66.00	17	-
Prahladrai Ramdayal Heda Designation: Chairman & Whole Time Director Educational Qualification: Qualified Eight (VIII th) Standard Term of office: 5 years w.e.f. May 01, 2024	64	2022	22.00	15	-
Manish Kumar Heda Designation: Chief Financial Officer Educational Qualification: Bachelor of Commerce Term of office: 5 years w.e.f. May 01, 2024	35	2024	NIL	15	-

Nikita Sharma Designation: Company Secretary and Compliance Officer Educational Qualification - Company Secretary	33	2024	NIL	6	Cubatics Industries Private Limited
--	----	------	-----	---	-------------------------------------

BRIEF PROFILE OF KEY MANAGERIAL PERSONNEL

Nitin Kumar Heda - Please refer to section “**Brief Profile of our Directors**” beginning on page 125 of this Prospectus for details.

Prahladrai Ramdayal Heda - Please refer to section “**Brief Profile of our Directors**” beginning on page 125 of this Prospectus for details.

Manish Kumar Heda is the Chief Financial Officer of our Company. He has completed his Bachelor of Commerce from University of Delhi in year 2009. He has a work experience of 15 years in the field of Accounts and Finance. He is responsible for handling the financial activities of the company including finance, accounts, statutory compliance, General operations, customer relations management of the Company.

Nikita Sharma is the Company Secretary and Compliance Officer of our Company. She is a qualified Company Secretary and an associate member of the Institute of Company Secretaries of India and she has been appointed as Company Secretary and Compliance Officer in our Company w.e.f. May 01, 2024. She has experience of 6 years of experience in the field of secretarial and corporate law compliances. She is responsible for undertaking various functions in our Company including corporate governance and secretarial matters and ensuring conformity with the regulatory provisions applicable to our company.

We confirm that:

- All the persons named as our Key Managerial Personnel above are the permanent employees of our Company.
- There is no understanding with major shareholders, customers, suppliers or any others pursuant to which any of the above mentioned Key Managerial Personnel have been recruited.
- None of our KMPs except Nitin Kumar Heda and Prahladrai Ramdayal Heda are also part of the Board of Directors.
- In respect of all above mentioned Key Managerial Personnel there has been no contingent or deferred compensation accrued for the period year ended March 31, 2024.
- Except for the terms set forth in the appointment letters, the Key Managerial Personnel have not entered into any other contractual arrangements or service contracts (including retirement and termination benefits) with the issuer.
- Our Company does not have any bonus/profit sharing plan for any of the Key Managerial Personnel.
- None of the Key Managerial Personnel hold any shares of our Company as on the date of filing of this Prospectus except as under.

Sr. No.	Name of the KMPs	No of shares held
1.	Nitin Kumar Heda	3,999,800
2.	Prahladrai Ramdayal Heda	1,999,900
	Total	59,99,700

- Presently, we do not have Employee Stock Option Plan (ESOP)/ Employee Stock Purchase Scheme (ESPS) for our employees.

Nature of any family relationship between our Directors and Key Managerial Personnel (KMP)

Except as detailed below, none of our Key Management Personnel or Directors are related to each other, within the meaning of section 2(77) of the Companies Act, 2013

Sr. No.	Name of the Director/KMPs	Relationship
1.	Nitin Kumar Heda	Brother of Manish Kumar Heda
2.	Prahladrai Ramdayal Heda	Uncle of Nitin Kumar Heda
3.	Khushboo Manishkumar Heda	Spouse of Manish Kumar Heda
4.	Manish Kumar Heda	Brother of Nitin Kumar Heda

Payment of benefits to officers of Our Company (non-salary related)

Except as disclosed in this Prospectus and any statutory payments made by our Company to its officers, our Company has not paid any sum, any non-salary related amount or benefit to any of its officers or to its employees including amounts towards superannuation, ex-gratia/rewards.

Except statutory benefits upon termination of employment in our Company or superannuation, no officer of our Company is entitled to any benefit upon termination of such officer’s employment in our Company or superannuation. Contributions are made by our

Company towards the Provident fund, Gratuity fund and Employee State Insurance

Changes in the Key Managerial Personnel in last three years:

There have been no changes in the Key Managerial Personnel of our Company during the last 3 (three) year except as stated below:

Sr. No.	Name of Directors/ KMP's	Designation and period	Appointment/ Cessation/Re-designation	Reasons
1.	Nitin Kumar Heda	Change in designation as Managing Director w.e.f. May 01, 2024	Change in designation	To comply with the provisions of the Companies Act 2013 and to ensure better Corporate Governance
2.	Prahladrai Ramdayal Heda	Change in designation as Chairman & Whole time Director w.e.f. May 01, 2024	Change in designation	
3.	Manish Kumar Heda	Appointed as Chief Financial Officer w.e.f. May 01, 2024	Appointment	
4.	Nikita Sharma	Appointed as Company Secretary & Compliance Officer w.e.f. May 01, 2024	Appointment	

Interest of our Key Managerial Personnel

Apart to the extent of remuneration allowed and reimbursement of expenses incurred by them for or on behalf of the Company, none of our Key Managerial Personal is interested in our Company. For details, please refer section titled "*Financial information of the Company – Annexure - J - Related Party Disclosures*" beginning on page 176 of this Prospectus.

Interest in the property of our Company

Our KMPs do not have any interest in any property acquired by our Company in a period of two years before the filing of this Prospectus or proposed to be acquired by us as on the date of filing the Prospectus with RoC.

Details of the Service Contracts of the Key Managerial Personnel

Except for the terms set forth in the appointment letters, the Key Managerial Personnel have not entered into any other contractual arrangements with our Company for provision of benefits or payments of any amount upon termination of employment.

Loans given/availed by Directors / Key Managerial Personnel of our Company

For details of unsecured loan taken from or given to our Directors/KMPs and for details of transaction entered by them in the past please refer to "*Annexure - J – Related Party Disclosure*" page 176 of this Prospectus.

Employee Stock Option Plan ('ESOP')/ Employee Stock Purchase Scheme ('ESPS Scheme') to Employees

Presently, we do not have any ESOP/ESPS Scheme for our employees.



OUR PROMOTERS & PROMOTER GROUP**OUR PROMOTERS:**

The Promoters of our Company are Nitin Kumar Heda, Prahladrai Ramdayal Heda, Khushboo Manishkumar Heda and Manish Kumar Heda.

As on date of this Prospectus, the Promoters, in aggregate, hold 79,99,600 Equity shares of our Company, representing 100.00% of the pre-issue paid-up Equity Share capital of our Company.

For details of the build-up of the Promoters shareholding in our Company, see “*Capital Structure – History of the Equity Share Capital held by our Promoters*” on pages 59 of this Prospectus.

Details of our Promoters are as follows:

	Nitin Kumar Heda –Managing Director	
	Qualification	Bachelor of Commerce (B.Com.)
	Age	36 years
	Date of Birth	October 01, 1987
	Address	7 Mangal Murti Society, Petlad Road, Nadiad, Kheda 387002, Gujarat, India.
	Experience	17 years
	Occupation	Business
	PAN	ABUPH8088C
	No. of Equity Shares & % of Shareholding (Pre Issue)	39,99,800 Equity Share aggregating to 50.00% of Pre Issue Paid up Share Capital of the Company.
	Other Ventures	Companies: a. Santram Metals And Alloys Private Limited HUF's: b. Nitinkumar Akshaykumar Heda HUF c. Akshaykumar Ramdayal Heda HUF (Member)
	Prahladrai Ramdayal Heda - Chairman & Whole time Director	
	Qualification	8 th
	Age	64 Years
	Date of Birth	February 05, 1960
	Address	62 Prime Flora, Near Santram Deri, Nadiad, Kheda 387002, Gujarat, India.
	Experience	15 Years
	Occupation	Business
	PAN	AHFPS0526H
	No. of Equity Shares & % of Shareholding (Pre Issue)	19,99,900 Equity Share aggregating to 25.00% of Pre Issue Paid up Share Capital of the Company.
	Other Ventures	Companies: a. Heda Sanghatan Seva Foundation HUF's: b. Prahladrai Ramdayal Heda HUF

	Khushboo Manishkumar Heda – Non-Executive Director	
	Qualification	Master of Business Administration
	Age	35 years
	Date of Birth	February 05, 1989
	Address	7 Mangal Murti Society, Petlad Road, Nadiad, Kheda 387002, Gujarat, India.
	Experience	6 Years
	Occupation	Business
	PAN	CQOPS0236G
	No. of Equity Shares & % of Shareholding (Pre Issue)	19,99,900 Equity Share aggregating to 25.00% of Pre Issue Paid up Share Capital of the Company.
	Other Ventures	HUF's: a. Manishkumar Akshaykumar Heda HUF (Member)
	Manish Kumar Heda – Promoter & Chief Financial Officer	
	Qualification	Bachelor of Commerce
	Age	35 years
	Date of Birth	December 10, 1988
	Address	7 Mangal Murti Society, Petlad Road, Nadiad, Kheda 387002, Gujarat, India.
	Experience	15 Years
	Occupation	Business
	PAN	ACEPH9256R
	No. of Equity Shares & % of Shareholding (Pre Issue)	Nil
	Other Ventures	Companies: d. Sunlite Aluminium Private Limited HUF's: b. Manishkumar Akshaykumar Heda HUF(Karta)

BRIEF PROFILE OF PROMOTERS

1. **Nitin Kumar Heda** - Please refer to chapter “**Our Management**” beginning on page 125 of this Prospectus for details.
2. **Prahladrai Ramdayal Heda** - Please refer to chapter “**Our Management**” beginning on page 125 of this Prospectus for details.
3. **Khushboo Manishkumar Heda** - Please refer to chapter “**Our Management**” beginning on page 125 of this Prospectus for details.
4. **Manish Kumar Heda** - Please refer to chapter “**Our Management**” beginning on page 125 of this Prospectus for details.

Confirmations/Declarations:

In relation to our Promoters, Nitin Kumar Heda, Prahladrai Ramdayal Heda, Khushboo Manishkumar Heda and Manish Kumar Heda, our Company confirms that the PAN, Bank Account Numbers, Passport Number, Aadhaar Card Number and Driving License number shall be submitted to stock exchange at the time of filing of this Prospectus.

Undertaking/ Confirmations:

None of our Promoters or Promoter Group or Group Companies or person in control of our Company has been:

- prohibited or debarred from accessing or operating in the capital market or restrained from buying, selling or dealing in securities under any order or direction passed by SEBI or any other authority or
- refused listing of any of the securities issued by such entity by any stock exchange, in India or abroad.

- No material regulatory or disciplinary action is taken by any by a stock exchange or regulatory authority in the past one year in respect of our Promoters, Group Companies and Company promoted by the Promoters of our company.
- There are no defaults in respect of payment of interest and principal to the debenture / bond / fixed deposit holders, banks, FIs by our Company, our Promoters, Group Companies and Company promoted by the Promoters during the past three years.
- Our Company or any of our Promoters or Group Companies or Directors are not declared as 'Fraudulent Borrower' by the lending banks or financial institution or consortium, in terms of RBI master circular dated July 01, 2016.
- The litigation record, the nature of litigation, and status of litigation of our Company, Promoters, Group Companies and Company promoted by the Promoters is disclosed in chapter titled **“Outstanding Litigations and Material Developments”** beginning on page 195 of this Prospectus.
- None of our Promoters, person in control of our Company is or have ever been a promoters, directors or person in control of any other company which is debarred from accessing the capital markets under any order or direction passed by the SEBI or any other authority.

Interest of our Promoters:

i. Interest in promotion and shareholding of Our Company:

Our Promoters is interested in the promotion of our Company and also to the extent of their shareholding and shareholding of their relatives, from time to time, for which they are entitled to receive dividend payable, if any, and other distribution in respect of the Equity Shares held by them and their relatives. As on the date of this Prospectus, our Promoters, Nitin Kumar Heda, Prahladrai Ramdayal Heda, Khushboo Manishkumar Heda and Manish Kumar Heda have collectively holds 79,99,600 Equity Shares in our Company i.e. 100.00% of the pre issue paid up Equity Share Capital of our Company. Our Promoters may also be deemed to be interested to the extent of the remuneration, as per the terms of their appointment and reimbursement of expenses payable to them for the rent, purchase and sale transactions. For details, please refer to **Annexure - J – “Related Party Transactions”** beginning on page 176 of this Prospectus.

For details regarding the shareholding of our Promoters in our Company, please see **“Capital Structure”** on page 59 of this Prospectus.

ii. Interest in the property of Our Company:

Except as mentioned hereunder, Our Promoters do not have any other interest in any property acquired by our Company in a period of two years before filing of this Prospectus or proposed to be acquired by us as on date of this Prospectus.

Sr. No.	Name of Promoter	Address of Property	Interest and nature of interest
1.	Nitin Kumar Heda	Survey No. 270A & Plot No. 1 Survey No. 267, Chhatha Mile, Dantali, Vaso, Kheda -387350, Gujarat, India.	The said property has been obtained on rent from Nitin Kumar Heda vide rent agreement dated February 06, 2024 for a period of 11 months at a rent of Rs. 1,40,000 p.m. w.e.f. February 01, 2024.

iii. In transactions for acquisition of land, construction of building and supply of machinery:

None of our Promoters or Directors is interested in any transaction for the acquisition of land, construction of building or supply of machinery.

iv. Other Interests in our Company:

For transactions in respect of loans and other monetary transactions entered in past please refer **Annexure - J** on **“Related Party Transactions”** on page 176 forming part of **“Financial Information of the Company”** of this Prospectus.

Further, our Promoters may be interested to the extent of personal guarantees given by them in favour of the Company, for the details of Personal Guarantee given by Promoters towards Financial facilities of our Company please refer to **“Statement of Financial Indebtedness”** and **“Financial Information of Our Company”** on page 182 and 144 respectively of this Prospectus.

Payment or Benefits to our Promoters and Promoter Group during the last 2 years:

For details of payments or benefits paid to our Promoters and promoter group, please refer to the paragraph “*Compensation of our Managing Director*” in the chapter titled “*Our Management*” beginning on page 125 also refer Annexure - J on “*Related Party Transactions*” on page 176 forming part of “*Financial Information of the Company*” and Paragraph on “*Interest of Promoters*” in chapter titled “*Our Promoters and Promoter Group*” on page 138 of this Prospectus.

Companies/Firms with which our Promoters have disassociated in the last (3) three years

None of our Promoters have disassociated themselves from any of the Company, Firms or other entities during the last three years preceding the date of this Prospectus.

Other ventures of our Promoters

Save and except as disclosed in this section titled “*Our Promoters & Promoter Group*” beginning on page 138 of this Prospectus, there are no ventures promoted by our Promoters in which they have any business interests/ other interests.

Litigation details pertaining to our Promoters

For details on litigations and disputes pending against the Promoters and defaults made by the Promoters please refer to the section titled “*Outstanding Litigations and Material Developments*” beginning on page 195 of this Prospectus.

Experience of Promoters in the line of business

Our Promoters, Nitin Kumar Heda, Prahladrai Ramdayal Heda, Khushboo Manishkumar Heda and Manish Kumar Heda have an experience of around 17 years, 15 years, 6 years and 15 years respectively in the business of Copper Manufacturing Industry. The Company shall also endeavor to ensure that relevant professional help is sought as and when required in the future.

Related Party Transactions

Except as stated in “*Annexure - J Related Party Transactions*” beginning on page 176 of this Prospectus, and as stated therein, our Promoters or any of the Promoter Group Entities do not have any other interest in our business.

OUR PROMOTER GROUP

In addition to the Promoters named above, the following natural persons are part of our Promoter Group:

1. Natural Persons who are part of the Promoter Group:

As per Regulation 2(1)(pp)(ii) of the SEBI (ICDR) Regulations, 2018, the Natural persons who are part of the Promoter Group (due to their relationship with the Promoter) are as follows:

Relationship	Name of the Relatives			
	Nitin Kumar Heda	Prahladrai Ramdayal Heda	Khushboo Manishkumar Heda	Manish Kumar Heda
Father	Akshay Kumar Heda	Late Ramdayal Motilal Heda	Chand Mal Somani	Akshay Kumar Heda
Mother	Sharda Kumari Heda	Late Rajbai Ramdayal Heda	Radha Devi Somani	Sharda Kumari Heda
Spouse	Komal Heda	Ladkumari Prahladrai Heda	Manish Kumar Heda	Khushboo Manishkumar Heda
Brother	Manish Kumar Heda	Kaluram Ramdayal Heda, Akshay Kumar Heda, Late Puranmal Heda	Rajat Somani	Nitin Kumar Heda
Sister	-	-	Meenakshi Abhi Shah, Anuradha Somani	-
Son	-	Pankaj P Heda	Nishit Manishkumar Heda	Nishit Manishkumar Heda
Daughter	Lavishka Nitinkumar Heda, Jenisha Nitinkumar Heda	Dimple Mandovara Harish	-	-

Spouse's Father	Satish Kumar Ramnivas Shah	Late Gehrilal Mohanlal Mundra	Akshay Kumar Heda	Chand Mal Somani
Spouse's Mother	Manjulaben Satishbhai Shah	Late Sajjandevi Mundra	Sharda Kumari Heda	Radha Devi Somani
Spouse's Brother	Pratik Shah	Late Rameshwarlal Mundra, Shantilal Gehrilal Shah, Kailashchandra G Shah	Nitin Kumar Heda	Rajat Somani
Spouse's Sister	Pinal Toshniwal	Manju Devi, Kanchanben Shah	-	Meenakshi Abhi Shah, Anuradha Somani

2. Corporate Entities or Firms forming part of the Promoter Group:

As per Regulation 2(1)(pp)(iv) of the SEBI (ICDR) Regulations, 2018, the following entities would form part of our Promoter Group:

S. No.	Nature of Relationship	Name of Entities
1.	Any Body Corporate in which 20% or more of the Equity Share Capital is held by Promoters or an immediate relative of the Promoters or a firm or Hindu Undivided Family (HUF) in which Promoters or any one or more of his immediate relatives are a member.	a. Santram Metals And Alloys Private Limited b. Sunlite Aluminium Private Limited
2.	Any Body Corporate in which a body corporate as provided in (A) above holds twenty per cent. or more, of the equity share capital; and	--
3.	Any Hindu Undivided Family or firm in which the aggregate share of the Promoters and their relatives is equal to or more than twenty per cent. of the total capital;	a. Nitinkumar Akshaykumar Heda HUF b. Prahladrai Ramdayal Heda HUF c. Heda Sanghatan Seva Foundation d. Akshaykumar Ramdayal Heda HUF e. Manishkumar Akshaykumar Heda HUF

3. Other persons included in Promoter Group:

None of other persons forms part of promoter group for the purpose of shareholding of the Promoter Group under Regulation 2(1)(pp)(v) of SEBI (ICDR) Regulations 2018.

DIVIDEND POLICY

Under the Companies Act, 2013, our Company can pay dividends upon a recommendation by its Board of Directors and approval by a majority of the shareholders at the General Meeting and as per provisions of Articles of Association of our Company. The shareholders of the Company have the right to decrease but not to increase the amount of dividend recommended by the Board of Directors. The dividends may be paid out of profits of our Company in the year in which the dividend is declared or out of the undistributed profits or reserves of previous fiscal years or out of both.

The Articles of Association of our Company also gives the discretion to our Board of Directors to declare and pay interim dividends. No dividend shall be payable for any financial year except out of profits of our Company for that year or that of any previous financial year or years, which shall be arrived at after providing for depreciation in accordance with the provisions of Companies Act, 2013. All Dividends upon recommendation by our Board of Directors and approved by the shareholders at the General Meeting will be paid to credit of registered shareholders by way of cheque or warrant or in any electronic mode.

Our Company does not have a formal dividend policy for declaration of dividend in respect of Equity shares. The declaration and payment of dividend will be recommended by our Board of Directors and approved by the shareholders of our Company at their discretion and will depend on a number of factors, including the results of operations, earnings, capital requirements and surplus, general financial conditions, applicable Indian legal restrictions and other factors considered relevant by our Board of Directors.

Our Company has not declared any dividend on the Equity Shares in the last three financial years and for the period from April 01, 2024 to the date of the filing of this Prospectus. Our Company's corporate actions pertaining to payment of dividends in the past are not to be taken as being indicative of the payment of dividends by our Company in the future.

SECTION VI

FINANCIAL INFORMATION OF THE COMPANY

INDEPENDENT AUDITOR'S EXAMINATION REPORT ON RESTATED FINANCIAL INFORMATION

To,
The Board of Directors,
Sunlite Recycling Industries Limited
(formerly known as Sunlite Alucop Private Limited)
Survey No. 270A & Plot No. 1, Survey No. 267,
Chhatha Mile, Dantali, Kheda, Gujarat - 387350. India.

Dear Sir,

Reference: - Proposed Public Issue of Equity Shares of **Sunlite Recycling Industries Limited.**

We have examined the attached Restated Audited Financial Information of **Sunlite Recycling Industries Limited (formerly known as Sunlite Alucop Private Limited)** comprising the Restated Audited Statement of Assets and Liabilities as at 31st March, 2024, 31st March, 2023 and 31st March, 2022, the Restated Audited Statement of Profit & Loss and the Restated Audited Cash Flow Statement for financial year ended on 31st March, 2024, 31st March, 2023, and 31st March, 2022, the statement of Significant Accounting Policies and other explanatory Information (Collectively the Restated Financial Information) as approved by the Board of Directors in their meeting held on July 20, 2024 for the purpose of inclusion in the Red Herring Prospectus/Prospectus ("Offer Document") in connection with its proposed Initial Public Offering (IPO) of equity shares, prepared by the Company in connection with its Initial Public Offer of Equity Shares (IPO) and prepared in terms of the requirement of:

- i. Section 26 and 32 of Part I of Chapter III of the Companies Act, 2013 as amended (the "Act");
- ii. The Securities and Exchange Board of India (Issue of Capital and Disclosure Requirements) Regulations 2018 ("ICDR Regulations") as amended (ICDR Regulations"); and related amendments / clarifications from time to time issued by the Securities and Exchange Board of India ("SEBI");
- iii. The Guidance Note on Reports in Company Prospectuses (Revised 2020) issued by the Institute of Chartered Accountants of India as amended from time to time. ("The Guidance Note").

The Company's Board of Directors is responsible for the preparation of the Restated Financial Information for the purpose of inclusion in the Draft Red Herring Prospectus/ Red Herring Prospectus/Prospectus to be filed with Stock Exchange, Securities and Exchange Board of India and Registrar of Companies, Ahmedabad in connection with the proposed IPO. The Restated Financial Information has been prepared by the management of the Company for financial year ended on 31st March, 2024, 31st March, 2023 and 31st March, 2022 on the basis of notes to restatement in Annexure D to the Restated Financial Information. The Board of Directors of the company's responsibility includes designing, implementing and maintaining adequate internal control relevant to the preparation and presentation of the Restated Financial Information. The board of directors are also responsible for identifying and ensuring that the Company complies with the Act, ICDR Regulations and the Guidance Note.

We have examined such Restated Financial Information taking into consideration:

- a. The terms of reference and terms of our engagement agreed upon with you in accordance with our engagement letter dated 16th January 2024 in connection with the proposed IPO of equity shares of the Company;
- b. The Guidance Note also requires that we comply with the ethical requirements of the Code of Ethics issued by the ICAI;
- c. Concepts of test checks and materiality to obtain reasonable assurance based on verification of evidences supporting the Restated Financial Information; and,
- d. The requirements of Section 26 of the Act and the ICDR Regulations. Our work was performed solely to assist you in meeting your responsibilities in relation to your compliance with the Act, the ICDR Regulations and the Guidance Note in connection with the IPO.

This Restated Financial Information has been compiled by the management from:

Audited financial statements of company as at and for financial year ended on 31st March, 2024, 31st March, 2023 and 31st March, 2022 prepared in accordance with the Accounting Standards as prescribed under Section 133 of the Act, read with Rule 7 of the Companies (Accounts) Rules, 2014, as amended, and other accounting principles generally accepted in India.

For the purpose of our examination, we have relied on:

- a. Auditors' Report issued by us for the year ended on 31st March, 2024 dated 20th July, 2024, Further Auditors Report issued by Gopal Shah & Co; Chartered Accountants for the financial year ended on 31st March, 2023 as on 29th September, 2023 as well as Auditors Report issued by Rajmal Maliwal & Co., Chartered Accountants for the financial year ended on 31st March, 2022 as on 20th September, 2022 respectively.

- b. The audit was conducted by the Company's previous statutory auditors, and accordingly reliance has been placed on the statement of assets and liabilities and statements of profit and loss, the Significant Accounting Policies, and other explanatory information and (collectively, the Audited Financial Statement") examined by them for the said years.

The modification in restated financials were carried out based on the modified reports, if any, issued by us which is giving rise to modifications on the financial statements as at and for the financial year ended on 31st March, 2024, & issued by Previous auditors which is giving rise to modifications on the financial statements as at and for financial year ended on 31st March, 2023 and 31st March, 2022. There is no qualification by us for the Financial Statement for the financial year ended on 31st March, 2024, & no qualification of previous auditor for financial year ended on financial year ended on 31st March, 2023 and 31st March, 2022.

The audit reports on the financial statements were modified and included following matter(s) giving rise to modifications on the Restated financial statements for the for the financial year ended on 31st March, 2024, 31st March, 2023 and 31st March, 2022:

- a) The Restated Financial Information or Restated Financial Statement have been made after incorporating adjustments for the changes in accounting policies retrospectively in respective financial years to reflect the same accounting treatment as per the changed accounting policy for all reporting periods, if any;
- b) The Restated Financial Information or Restated Financial Statement have been made after incorporating adjustments for prior period and other material amounts in the respective financial years to which they relate and there are no qualifications which require adjustments;
- c) Extra-ordinary items that needs to be disclosed separately in the accounts has been disclosed wherever required;
- d) There are no qualifications in the Audit Reports issued by us for the financial year ended on 31st March, 2024 and no qualification is in the Audit Report issued by Gopal Shah & Co for financial year ended 31st March, 2023, as well as no qualifications in the Audit Reports issued by Rajmal Maliwal & Co., Chartered Accountants for the financial year ended on 31st March, 2022 which would require adjustments in this Restated Financial Statements of the Company;
- e) Profits and losses have been arrived at after charging all expenses including depreciation and after making such adjustments/restatements and regroupings as in our opinion are appropriate and are to be read in accordance with the Significant Accounting Polices and Notes to Accounts as set out in ANNEXURE - D to this report;
- f) Adjustments in Restated Financial Information or Restated Financial Statement have been made in accordance with the correct accounting policies;
- g) There was no change in accounting policies, which needs to be adjusted in the Restated Financial Information or Restated Financial Statement;
- h) The Company has valued its obligations related to Gratuity as per AS -15.
- i) There are no revaluation reserves, which need to be disclosed separately in the Restated Financial Information or Restated Financial Statement;
- j) The related party transaction for purchase & sales of Goods entered by the company are at arm's length price;
- k) The Company has not paid any dividend since its incorporation;

In accordance with the requirements of Part I of Chapter III of Act including rules made there under, ICDR Regulations, Guidance Note and Engagement Letter, we report that:

- a) The "Restated Statement of Assets and Liabilities" as set out in ANNEXURE – A to this report, of the Company, for the financial year ended on 31st March, 2024, 31st March, 2023 and 31st March, 2022 is prepared by the Company and approved by the Board of Directors. These Restated Statement of Assets and Liabilities, have been arrived at after making such adjustments and regroupings to the individual financial statements of the Company, as in our opinion were appropriate and more fully described in Significant Accounting Policies and Notes to Accounts as set out in ANNEXURE – D to this Report.

- b) The “Restated Statement of Profit and Loss” as set out in ANNEXURE – B to this report, for the financial year ended on 31st March, 2024, 31st March, 2023 and 31st March, 2022 is prepared by the Company and approved by the Board of Directors. These Restated Statement of Profit and Loss have been arrived at after making such adjustments and regroupings to the individual financial statements of the Company, as in our opinion were appropriate and more fully described in Significant Accounting Policies and Notes to Accounts as set out in ANNEXURE – D to this Report.
- c) The “Restated Statement of Cash Flow” as set out in ANNEXURE – C to this report, the financial year ended on 31st March, 2024, 31st March, 2023 and 31st March, 2022 is prepared by the Company and approved by the Board of Directors. These Statement of Cash Flow, as restated have been arrived at after making such adjustments and regroupings to the individual financial statements of the Company, as in our opinion were appropriate and more fully described in Significant Accounting Policies and Notes to Accounts as set out in ANNEXURE – D to this Report.

Audit for the financial year ended on 31st March, 2024 has conducted by us & Audit for the financial year ended on March 31, 2023 was conducted by Gopal Shah & Co; Chartered Accountants and Audit for the financial year ended on 31st March, 2022 has conducted by Rajmal Maliwal & Co., Chartered Accountants and accordingly reliance has been placed on the financial statement examined by them for the said years. Financial Reports included for said years are solely based on report submitted by them.

We have also examined the following other financial information relating to the Company prepared by the Management and as approved by the Board of Directors of the Company and annexed to this report relating to the Company for the financial year ended on 31st March, 2024, 31st March, 2023 and 31st March, 2022 proposed to be included in the Red Herring Prospectus/ Prospectus for the proposed IPO.

Restated Statement of Share Capital & Reserves and Surplus	Annexure – A.1 Annexure – A.2
Restated Statement of Long Term Borrowing	Annexure – A.3
Restated Statement of Long Term Provision	Annexure – A.4
Restated Statement of Deferred Tax (Assets) / Liabilities	Annexure – A.11
Restated Statement of Short Term Borrowing	Annexure – A.5
Restated Statement of Trade Payables	Annexure – A.6
Restated Statement of Other Current Liabilities And Short Term Provisions	Annexure – A.7 & A.8
Restated Statement of Fixed Assets	Annexure – A.9
Restated Statement of Non-Current Investments	Annexure – A.10
Restated Statement of Long-term loans and advances	Annexure – A.12
Restated Statement of Other Non-Current Assets	Annexure – A.13
Restated Statement of Inventories	Annexure – A.14
Restated Statement of Trade Receivables	Annexure – A.15
Restated Statement of Cash & Cash Equivalents	Annexure – A.16
Restated Statement of Short Term Loans & Advances	Annexure – A.17
Restated Statement of Other Current Assets	Annexure – A.18
Restated Statement of Revenue from Operations	Annexure – B.1
Restated Statement of Other Income	Annexure – B.2
Restated Statement of Cost of Material Consumed And Purchase of Stock-in-Trade	Annexure – B.3& B 3.1
Restated Statement of Changes in Inventory of Finished Goods, WIP & Packing material	Annexure – B.4
Restated Statement of Employee Benefit Expenses	Annexure – B.5
Restated Statement of Finance Cost	Annexure – B.6
Restated Statement of Depreciation & Amortisation	Annexure – B.7
Restated Statement of Other Expenses	Annexure – B.8
Restated Statement of Deferred Tax Asset / Liabilities	Annexure – B.9
Restated Statement of Cash Flows	Annexure – C
Significant Accounting Policy and Notes to The Restated financial Statements	Annexure – D
Statement of Material Adjustment To The Restated Financial Statement	Annexure – E
Restated Statement of Tax shelter	Annexure – F
Restated Statement of Capitalization	Annexure – G
Restated Statement of Contingent Liabilities	Annexure – H
Restated Statement of Mandatory Accounting Ratios	Annexure – I
Restated Statement of Related Party Transaction	Annexure – J
Restated Statement of Other Financial Ratio	Annexure-K

In our opinion and to the best of information and explanation provided to us, the Restated Financial Information of the Company, read with significant accounting policies and notes to accounts as appearing in ANNEXURE – D are prepared after providing appropriate adjustments and regroupings as considered appropriate.

We, Abhishek Kumar & Associates, Chartered Accountants have been subjected to the peer review process of the Institute of Chartered Accountants of India (“ICAI”) and hold a valid peer review certificate issued by the “Peer Review Board” of the ICAI.

The preparation and presentation of the Financial Statements referred to above are based on the Audited financial statements of the Company and are in accordance with the provisions of the Act and ICDR Regulations. The Financial Statements and information referred to above is the responsibility of the management of the Company.

The report should not in any way be construed as a re-issuance or re-dating of any of the previous audit reports issued by any other Firm of Chartered Accountants nor should this report be construed as a new opinion on any of the financial statements referred to therein.

We have no responsibility to update our report for events and circumstances occurring after the date of the report.

In our opinion, the above financial information contained in ANNEXURE – A to K of this report read with the respective Significant Accounting Policies and Notes to Accounts as set out in ANNEXURE – D are prepared after making adjustments and regrouping as considered appropriate and have been prepared in accordance with the Companies Act, SEBI ICDR Regulations, Engagement Letter and Guidance Note issued by ICAI.

Our report is intended solely for use of the management and for inclusion in the offer Document in connection with the Proposed SME IPO of Equity Shares of the Company and our report should not be used, referred to or distributed for any other purpose without our prior consent in writing.

For, Abhishek Kumar & Associates
Chartered Accountants
FRN: 130052W
Peer Review Certificate No: 011266

Sd/-
CA Abhishek Agrawal
Proprietor
M. No.: 132305
Place: Ahmedabad
Date: July 20, 2024
UDIN: 24132305BKEYYX5316

ANNEXURE – A: RESTATED STATEMENT OF ASSETS AND LIABILITIES

(Amount in Rs. Lakhs)

Particulars	Note No.	As at		
		March 31, 2024	March 31, 2023	March 31, 2022
A. Equity and Liabilities				
1 Shareholders' Funds				
Share Capital	A.1	800.00	50.00	1,158.58
Reserves & Surplus	A.2	1,203.90	312.08	0.00
Share application money pending allotment				
2 Non-Current Liabilities				
Long-Term Borrowings	A.3	342.83	2,238.38	1,135.52
Long-Term Provisions	A.4	4.71	3.71	2.28
Deferred Tax Liabilities (Net)	A.11	55.81	63.33	72.42
3 Current Liabilities				
Short Term Borrowings	A.5	3,148.91	2,408.44	1,396.86
Trade Payables:	A.6			
(A) total outstanding dues of micro enterprises and small enterprises; and		0.80	436.62	188.31
(B) total outstanding dues of creditors other than micro enterprises and small enterprises."		49.75	1,167.37	658.79
Other Current Liabilities	A.7	397.66	277.21	30.85
Short Term Provisions	A.8	316.87	205.42	158.43
Total		6,321.24	7,162.56	4,802.05
B. Assets				
1 Non-Current Assets				
Property, Plant and Equipment	A.9			
Tangible Assets		1,386.07	1,387.82	1,334.64
Intangible Assets		0.00	0.00	0.00
Non-Current Investments	A.10	0.00	0.00	0.00
Deferred Tax Assets	A.11	0.00	0.00	0.00
Long Term Loans & Advances	A.12	0.00	0.00	0.30
Other Non-Current Assets	A.13	25.82	84.17	48.44
2 Current Assets				
Current Investments		0.00	0.00	0.00
Inventories	A.14	2,969.56	3,875.67	2,404.54
Trade Receivables	A.15	1,422.40	1,167.75	505.35
Cash and Cash Equivalents	A.16	7.34	203.22	4.77
Short-Term Loans and Advances	A.17	162.51	123.46	299.63
Other Current Assets	A.18	347.54	320.47	204.39
Total		6,321.24	7,162.56	4,802.05

ANNEXURE – B: RESTATED STATEMENT OF PROFIT AND LOSS

(Amount in Rs. Lakhs)

Particulars	Note No.	For the year ended		
		March 31, 2024	March 31, 2023	March 31, 2022
A. Revenue:				
Revenue from Operations	B.1	1,16,627.09	1,15,018.88	93,719.32
Other income	B.2	28.00	21.03	72.48
Total revenue		1,16,655.09	1,15,039.91	93,791.80
B. Expenses:				
Cost of Material Consumed	B.3	1,10,513.26	1,10,097.69	90,290.65
Purchase of Stock-in-Trade	B 3.1	1,934.21	1,553.49	693.04
Change in Inventories of WIP, Finished Goods & Packing Material	B.4	-653.18	-370.86	-35.37
Employees Benefit Expenses	B.5	249.81	229.44	156.05
Finance costs	B.6	468.23	472.76	290.79
Depreciation and Amortization	B.7	243.26	239.16	219.98
Other expenses	B.8	2,719.49	2,062.74	1,612.13
Total Expenses		1,15,475.08	1,14,284.42	93,227.27
Profit before exceptional and extraordinary items and tax		1,180.01	755.49	564.53
Exceptional Items		0.00	0.00	0.00
Profit before extraordinary items and tax		1,180.01	755.49	564.53
Extraordinary items		0.00	0.00	0.00
Profit before tax		1,180.01	755.49	564.53
Tax expense:				
Current tax		297.18	204.31	148.12
Deferred Tax	B.9	-7.53	-9.09	-9.62
Profit (Loss) for the period from continuing operations		890.36	560.27	426.03
Earning per equity share in Rs.:				
(1) Basic		19.35	14.01	10.65
(2) Diluted		19.35	14.01	10.65

ANNEXURE – C
RESTATED STATEMENT OF CASH FLOWS

(Amount in Rs. Lakhs)

Particulars	For the year ended		
	March 31, 2024	March 31, 2023	March 31, 2022
A. CASH FLOW FROM OPERATING ACTIVITIES			
Profit/ (Loss) before tax	1,180.01	755.49	564.53
Adjustments for:			
Depreciation	243.26	239.16	219.98
Finance Cost	468.23	472.76	290.79
Interest Income	-10.00	-3.16	-63.36
Operating profit before working capital changes	1,881.50	1,464.25	1,011.94
Movements in working capital :			
(Increase)/Decrease in Inventories	906.11	-1,471.13	-1,307.42
(Increase)/Decrease in Trade Receivables	-254.65	-662.40	173.31
(Increase)/Decrease in Short Term Loans & Advances	-39.05	176.17	-66.50
(Increase)/Decrease in Other Current Assets	-27.07	-116.08	-162.04
Increase/(Decrease) in Trade Payables	-1,553.44	756.89	-283.56
Increase/(Decrease) in Other Current Liabilities	120.45	246.36	-117.41
Increase/(Decrease) in Long Term Provisions	1.00	1.43	1.52
Increase/(Decrease) in Short Term Provisions	111.45	46.99	110.54
Cash generated from operations	1,146.31	442.47	-639.62
Adjustment on Account of Income Tax Expense	-17.31	-204.31	-148.12
Net cash from operating activities (A)	1,128.99	238.16	-787.74
B. CASH FLOW FROM INVESTING ACTIVITIES			
Sale/(Purchase) of Investments	0.00	0.00	0.00
(Increase)/Decrease in Long Term Loans & Advances	0.00	0.30	-0.30
Interest Income	10.00	3.16	63.36
Sale/(Purchase) of Fixed Assets	-241.51	-292.33	-308.22
(Increase)/Decrease in Other Non-Current Assets	58.35	-35.73	16.33
Net cash from investing activities (B)	-173.16	-324.60	-228.83
C. CASH FLOW FROM FINANCING ACTIVITIES			
Interest/Other expenses paid on borrowings	-468.23	-472.76	-290.79
Proceeds/(Repayment) of Long Term Borrowings	-1,895.55	1,102.86	-130.01
Increase/(Decrease) in Short Term Borrowings	740.47	1,011.58	951.00
Increase/(Decrease) in Capital	471.60	-1,356.79	110.37
Net cash from financing activities (C)	-1,151.71	284.89	640.57
Net increase in cash and cash equivalents (A+B+C)	-195.88	198.45	-376.00
Cash and cash equivalents at the beginning of the year	203.22	4.77	380.77
Cash and cash equivalents at the end of the year	7.34	203.22	4.77

Note 1: Balances stated above has been rounded off in nearest Rs. 10 to remove the fractional differences from the balances as mentioned in Balance sheet

ANNEXURE – D
SUMMARY STATEMENT OF SIGNIFICANT ACCOUNTING POLICY AND NOTES TO THE RESTATED FINANCIAL STATEMENTS

A. COMPANY INFORMATION

The Company was originally incorporated as “Sunlite Alucop Private Limited” on 04th August, 2022 under the provisions of the Companies Act, 2013 with the Registrar of Companies, Ahmedabad, with CIN U27200GJ2022PTC134540, prior to which the business was carried on as a partnership concern in the name of M/s. Sunlite Industries since September 2017. In January 2024, the company changed its name from Sunlite Alucop Private Limited to Sunlite Recycling Industries Private Limited. Subsequently, pursuant to Special Resolution passed by the Shareholders at the Extra Ordinary General Meeting, held on 10th February, 2024 the Company was converted into a Public Limited Company and consequently the name of the Company was changed from “Sunlite Recycling Industries Private Limited” to “Sunlite Recycling Industries Limited” vide a fresh certificate of incorporation consequent upon conversion from private company to public company dated 30th April, 2024 issued by the Registrar of Companies, Central Processing Centre bearing CIN: U27200GJ2022PLC134540. Company is engaged in the business of manufacturing of copper rods & wires, copper earthing wires, copper earthing strips, copper conductors, copper wire bars etc., which has electrical and mechanical properties suitable for applications in power generation, transmission, distribution and electronic industries.

B. STATEMENT OF SIGNIFICANT ACCOUNTING POLICIES

1. Basis of preparation of financial statements

The financial statement is prepared under the historical cost convention on the “Accrual Concept” and Going Concern assumptions of accountancy in accordance with the accounting principles generally accepted in India and comply with the accounting standards as prescribed by Companies (Accounting Standard) Rules, 2006 and with the relevant provisions of the Companies Act, 2013 and rules made there under.

The Restated Statement of Assets and Liabilities of the Company for the year ending as on March 31, 2024, March 31, 2023 and March 31, 2022 and the Restated Statement of Profit and Loss and Restated Statements of Cash Flows for the financial year ended on March 31, 2024, March 31, 2023 and March 31, 2022 and the annexure thereto (collectively, the “**Restated Financial Statements**”) have been extracted by the management from the Audited Financial Statements of the Company.

The financial statements of the company have been prepared and presented in accordance with the Generally Accepted Accounting Principles (GAAP). GAAP comprises the Accounting Standards notified u/s S.133 read with S.469 of the Companies Act, 2013. The accounting policies have been framed, keeping in view the fundamental accounting assumptions of Going Concern, Consistency and Accrual, as also basic considerations of Prudence, Substance over form, and Materiality. These have been applied consistently, except where a newly issued accounting standard is initially adopted or a revision in the existing accounting standards require a revision in the accounting policy so far in use. The need for such a revision is evaluated on an ongoing basis.

The Financial Statements have been prepared on a going concern basis, in as much as the management neither intends to liquidate the company nor to cease operations. Accordingly, assets, liabilities, income and expenses are recorded on a Going Concern basis. Based on the nature of products and services, and the time between the acquisition of assets and realization in cash or cash equivalents, the company has ascertained its operating cycle as 12 months for the purposes of current and non-current classification of assets and liabilities

2. Use of Estimates

The preparation of financial statements requires management to make estimates and assumptions that affect the reported amount of assets and liabilities on the date of the financial statement and the reported amount of revenues and expenses during the reporting period. Difference between the actual results and estimates are recognized in the period in which results are known/ materialized.

3. Property, Plant and Equipment

Property, Plant and Equipment are stated at cost less accumulated depreciation and impairment losses, if any. Cost comprises of all expenses incurred to bring the assets to its present location and condition. Borrowing cost directly attributable to the acquisition /construction is included in the cost of fixed assets. Adjustments arising from exchange rate variations attributable to the fixed assets are capitalized.

In case of new projects / expansion of existing projects, expenditure incurred during construction / preoperative period including interest and finance charge on specific / general purpose loans, prior to commencement of commercial production are capitalized. The same are allocated to the respective on completion of construction / erection of the capital project / fixed assets.

Subsequent expenditures related to an item of tangible asset are added to its book value only if they increase the future economic benefits from the existing asset beyond its previously assessed standard of performance.

Capital assets (including expenditure incurred during the construction period) under erection / installation are stated in the Balance Sheet as "Capital Work in Progress."

4. Impairment of Assets

At each balance sheet date, the Company reviews the carrying amount of its fixed assets to determine whether there is any indication that those assets suffered an impairment loss. If any such indication exists, the recoverable amount of the assets is estimated in order to determine the extent of impairment loss. Recoverable amount is the higher of an asset's net selling price and value in use. In assessing value in use, the estimated future cash flows expected from the continuing use of the assets and from its disposal are discounted to their present value using a pre-tax discount rate that reflects the current market assessments of time value of money and the risks specific to the assets.

5. Depreciation

All fixed assets, except capital work in progress, are depreciated on WDV Method. Depreciation is provided based on useful life of the assets and depreciation rates as prescribed in Schedule II to the Companies Act, 2013. Depreciation on additions to / deletions from fixed assets made during the period is provided on pro-rata basis from / up to the date of such addition / deletion as the case may be.

6. Investments

Investments are classified into current investments and non-current investments. Current investments i.e. investments that are readily realizable and intended to be held for not more than a year valued at cost. Any permanent reduction in the carrying amount or any reversals of such, reductions are charged or credited to the Statement of Profit & loss Account.

Non-current investments are stated at cost. Provision for diminution in the value of these investments is made only if such decline is other than temporary, in the opinion of the management.

7. Inventories

Inventories consist of Raw Materials, Stock of Work-in-Progress and Finished Goods and is valued at Cost or Net Realizable Value, whichever is lower.

8. Revenue Recognition

Revenue from the operations is recognized on generally accepted accounting principal and when it is earned, no significant uncertainty exists as to its ultimate collection and includes taxes, wherever applicable.

The capital gains on sale of investment if any are recognized on completion of transaction. No notional profits/losses are recognized on such investments.

Interest income is recognized on time proportion basis, when it is accrued and due for payment.

9. Borrowing Cost

Borrowing costs that are attributable to the acquisition, construction or production of qualifying assets are capitalized as part of the cost of such assets. A qualifying asset is one that necessarily takes a substantial period of time to get ready for its intended use. All other borrowing costs are charged to revenue.

10. Employee Benefits

Short-term employee benefits is recored as expenses in the profit and loss account for the year when the services are provided, without any adjustments for future events.

For post-employment and other long-term benefits, we recognize the expense in the profit and loss account in the year when the company becomes liable for them.

Top of Form

11. Taxes on Income

Income tax expenses for the year comprises of current tax and deferred tax. Current tax provision is determined on the basis of taxable income computed as per the provisions of the Income Tax Act. Deferred tax is recognized for all timing differences that are capable of reversal in one or more subsequent periods subject to conditions of prudence and by applying tax rates that have been substantively enacted by the balance sheet date.

12. Foreign Currency Transaction

- a) Transactions denominated in foreign currencies are recorded at the exchange rate prevailing at the date of the transaction. Monetary assets and liabilities denominated in foreign currencies at the year end are restated at closing rate.
- b) Any exchange difference on account of settlement of foreign currency transaction and restatement of monetary assets and liabilities denominated in foreign currency is recognized in the statement of Profit & loss Account.

13. Provision, Contingent Liabilities and Contingent Assets

Provisions involving substantial degree of estimation in measurement are recognized when there is a present obligation as a result of past events and it is probable that there will be an outflow of resources.

14. Earnings Per Share

In determining the Earnings Per share, the company considers the net profit after tax which does not include any post tax effect of any extraordinary / exceptional item. The number of shares used in computing basic earnings per share is the weighted average number of shares outstanding during the period.

15. Cash Flow:

Cash flows are reported using the indirect method, whereby profit before tax is adjusted for the effects of transactions of non-cash nature, any deferrals or accruals of past or future operating cash receipts or payments and item of income or expenses associated with investing or financing cash flows. Cash flows from operating, investing and financing activities of the Company are segregated, accordingly.

C. CHANGES IN ACCOUNTING POLICIES IN THE YEARS COVERED IN THE RESTATED FINANCIALS

There was no change in accounting policies, which needs to be adjusted in the Restated Financial Statement.

NOTES ON RESTATEMENTS MADE IN THE RESTATED FINANCIALS

1. Amounts are in lakhs except units are in actual numbers wherever required considered accordingly for respective computations.
2. The financial statements including financial information have been prepared after making such regroupings and adjustments, considered appropriate to comply with the same. As result of these regroupings and adjustments, the amount reported in the financial statements/information may not necessarily be same as those appearing in the respective audited financial statements for the relevant years.

3. Segment Reporting

The company is dealing in primary segment i.e. manufacturing of all kinds of Copper Scrap, Wire and Rod and secondary segment of trading. Company does't have separate parts of the business that focus on specific products or services, each with its own risks and rewards.

4. Post Employment Benefits:

The Company has valued its obligations related to Gratuity as follows:

I. ASSUMPTIONS

(Rs. in lakhs except units are in actual numbers)

Particulars	For the Year Ended on March 31, 2024	For the Year Ended on March 31, 2023	For the Year Ended on March 31, 2022
Discount Rate	7.2%	7.3%	6.4%
Expected Rate of Salary Increase	7%	7%	7%

Withdrawal Rates	Age 25 & Below	20 % p.a.	Age 25 & Below	20 % p.a.	Age 25 & Below	20 % p.a.
	25 to 35	20 % p.a.	25 to 35	20 % p.a.	25 to 35	20 % p.a.
	35 to 45	20 % p.a.	35 to 45	20 % p.a.	35 to 45	20 % p.a.
	45 to 55	20 % p.a.	45 to 55	20 % p.a.	45 to 55	20 % p.a.
	55 & above	20 % p.a.	55 & above	20 % p.a.	55 & above	20 % p.a.
Retirement	60 Years		60 Years		60 Years	

II. Change in the present value of defined benefit obligations

Particulars	For the Year Ended on March 31, 2024	For the Year Ended on March 31, 2023	For the Year Ended on March 31, 2022
Defined Benefit Obligation at beginning of the year	3.81	2.28	0.76
Current Service Cost	2.02	2.04	1.05
Interest cost	0.27	0.14	0.05
Actuarial (Gains)/Losses on Obligations	(1.07)	(0.65)	0.42
Defined Benefit Obligation as at end of the year	5.04	3.81	2.28

III. Amount recognized in the balance sheet:

Particulars	For the Year Ended on March 31, 2024	For the Year Ended on March 31, 2023	For the Year Ended on March 31, 2022
Net liability as at beginning of the year	3.81	2.28	0.76
Net expense recognized in the Statement of Profit and Loss	1.23	1.53	1.52
Expected Return on Plan Assets	-	-	-
Net liability as at end of the year	5.04	3.81	2.28

IV. Expense Recognized:

Particulars	For the Year Ended on March 31, 2024	For the Year Ended on March 31, 2023	For the Year Ended on March 31, 2022
Current Service Cost	2.02	2.04	1.05
Interest Cost	0.27	0.14	0.05
Return on Plan Assets	-	-	-
Actuarial (Gains)/Losses on Obligations	(1.07)	(0.65)	0.42
Expense charged to the Statement of Profit and Loss	1.23	1.53	1.52

V. Balance Sheet Reconciliation:

Particulars	For the Year Ended on March 31, 2024	For the Year Ended on March 31, 2023	For the Year Ended on March 31, 2022
Opening net liability	3.81	2.28	0.76
Expense as above	1.23	1.53	1.52
Provision Related to Previous Year booked as Prior Period Items	-	-	-
Return on Plan Assets	-	-	-
Benefits Paid	-	-	-
Net liability/(asset) recognized in the balance sheet	5.04	3.81	2.28

5. Foreign Currency Transaction (AS 11)

Foreign currency transaction includes Import and Export as per Accounting Standard – 11 as at the end of the year is reported as under.

(Amount in Rs. Lakhs)

Particulars	For the Year Ended on March 31, 2024	For the Year Ended on March 31, 2023	For the Year Ended on March 31, 2022
Foreign Exchange Earnings			
Sales			
Receipts in Foreign Currency	-	6.61	7.14
FOB Value of Exports	-	545.05	527.32
Foreign Exchange Outgoings			
Purchase			
Payments in Foreign Currency	366.76	127.72	11.86
CIF Value of Imports	30250.67	10512.15	874.90

6. Provisions, Contingent Liabilities and Contingent Assets (AS 29)

Contingent liabilities and commitments (to the extent not provided for). There are no contingent liabilities as on March 31, 2024 except as mentioned in Annexure-H, for any of the years covered by the statements

7. Related Party Disclosure (AS 18)

Related party transactions are reported as per AS-18 of Companies (Accounting Standards) Rules, 2006, as amended, in the Annexure – J of the enclosed financial statements.

8. Accounting For Taxes on Income (AS 22)

Deferred Tax liability/Asset in view of Accounting Standard – 22: “Accounting for Taxes on Income” as at the end of the year is reported as under.

(Amount in Rs. Lakhs)

Particulars	For the year ended on March 31, 2024	For the year ended on March 31, 2023	For the year ended on March 31, 2022
WDV as per Companies Act, 2013 (A)	1386.07	1,387.82	1,334.64
WDV as per Income tax Act, 1961 (B)	1,169.65	1,140.31	1,126.38
Difference in WDV (A-B)	216.42	247.51	208.26
Deferred Tax (Asset)/ Liability (C)	54.54	62.37	71.85
Gratuity as per Companies Act	5.04	3.82	2.28
Gratuity as per Income Tax Act	0.00	0.00	0.00
Difference (D-E)	5.04	3.82	2.28
Deferred Tax (Asset)/ Liability (F)	1.27	0.96	0.57
Restated Closing Balance of Deferred Tax (Asset)/ Liability	55.81	63.33	72.42
<u>Deferred Tax (Assets)/ Liability as per Balance sheet of Previous Year</u>	63.33	72.42	82.04
<u>Deferred Tax (Assets)/ Liability charged to Profit & Loss</u>	-7.53	(9.09)	(9.62)

9. Earnings Per Share (AS 20):

Earnings per Share have been calculated is already reported in the Annexure –I of the enclosed financial statements.

10. Realizations:

In the opinion of the Board and to the best of its knowledge and belief, the value on realization of current assets and loans and advances are approximately of the same value as stated.

11. Contractual liabilities

All other contractual liabilities connected with business operations of the Company have been appropriately provided for.

12. Amounts in the financial statements

Amounts in the financial statements are reported in Indian Rupees in lakhs and rounded off to second digit of decimal. Figures in brackets indicate negative values.

13. Auditors Qualifications –

Details of Auditors qualifications and their impact on restated financial statement is given below.

- a) Qualification which required adjustment in restated financial statements-NIL

- b) Qualification which does not require adjustment in restated financial statements – NIL

ANNEXURE-E
MATERIAL ADJUSTMENT TO THE RESTATED FINANCIAL STATEMENT

1 Material Regrouping:

Appropriate adjustments have been made in the Restated Financial Statements of Assets and Liabilities, Profit and Losses and Cash Flows, wherever required, by reclassification of the corresponding items of income, expenses, assets and liabilities in order to bring them in line with the regroupings as per the audited financial statements of the company and the requirements of SEBI Regulations.

2 Material Adjustments:

The Summary of results of restatement made in the Audited Financial Statements for the respective years and its impact on the profit/(loss) of the Company is as follows:

(Amount in Rs. lakhs)

Particulars	As at March 31, 2024	As at March 31, 2023	As at March 31, 2022
(A) Net Profits After Tax as per audited financial statements (A)	893.62	565.31	586.16
Add/(Less) : Adjustments on account of -			
1) Prepaid Expenses of P.Y. Transfer to Expenses	0.00	-11.10	-5.35
2) Prepaid Expenses of current Year	0.00	0.00	11.10
3) Provision for Expenses Payable	0.00	0.63	0.00
4) Expenses to be disallowed	0.00	0.00	0.32
5) Difference on Account of Calculation in Deferred Tax	6.61	16.56	9.62
6) Change in Provision for Current Tax	1.52	-0.54	-148.12
7) Change in Provision of Depreciation	-11.41	-10.47	-26.28
8) Change in Provision of Gratuity	0.00	-0.12	-1.42
Total Adjustments (B)	-3.25	-5.04	-160.13
Restated Profit/ (Loss) (A+B)	890.37	560.27	426.03

3 Explanatory notes to the above restatements to profits made in the audited Standalone Financial Statements of the Company for the respective years:

i. Difference on Account of Prepaid expenses of P.Y Transfer to Expenses

An impact of prepaid expenses is disclosed in the restated financial statements, which has not been included in the audited financial statements.

ii. Difference on Account of Prepaid expenses

An impact of prepaid expenses is disclosed in the restated financial statements, which has not been included in the audited financial statements.

iii. Difference on Account of Provision of expenses

The audited financial statements did not include provisions for expenses; nonetheless, the effects of such provisions are accounted for in the restated financial statements.

iv. Difference on Account of disallowed expenses

The restated financials present the effects of disallowed expenses, which were not disclosed in the audited financial statements.

v. Difference on Account of Change in Deferred Tax

Depreciation is provided as per normal provisions on the assets in Audited financials Statement of Partnership Firm of which effect has been given in Restated Financials as per Companies Act due to which, Deferred Tax Calculation got

changed. Further Gratuity provision was not made in Audited financials Statement of Partnership Firm of which effects has been given in Restated Financials as per actuarial report, due to which, Deferred Tax Calculation also got changed.

vi. Difference on Account of Change in Provision for Income Tax

Provision for Tax as calculated in Audited Financials was on Adhoc Basis, so that the same is recalculated in Restated Financials on actual basis.

vii. Difference on Account of Change in Depreciation Calculation

Depreciation is provided as per normal provisions on the assets in Audited financials Statement of Partnership Firm of which effect has been given in Restated Financials as per Companies Act due to which Depreciation amount was changed.

viii. Difference on Account of Provision for Gratuity

The audited financial statements of the partnership firm did not incorporate a provision for gratuity. Additionally, an ad hoc provision amount was made in the company's financial statements leading to adjustments in the restated financials based on the actuarial report.

Reconciliation of Equity

(Amount in Rs. lakhs)

Particulars	As at March 31, 2024	As at March 31, 2023	As at March 31, 2022
Equity Share Capital & Reserves & Surplus as per Audited financial Statement	1868.05	471.53	1,161.92
Add/(Less) : Adjustments on account of change in Profit/Loss	135.85	-109.45	-3.34
Total Adjustments	135.85	-109.45	-3.34
Equity Share Capital & Reserves & Surplus as per Restated Financial Statement	2003.90	362.08	1,158.58

4 ADJUSTMENTS HAVING NO IMPACT ON NETWORTH AND PROFIT:

a. Material Regrouping:

Appropriate regroupings have been made in the Restated Summary Statements, wherever required, by a reclassification of the corresponding items of income, expenses, assets, liabilities and cash flows in order to bring them in line with the groupings as per the audited Standalone Financial Statements of the Company, prepared in accordance with Schedule III and the requirements of the Securities and Exchange Board of India (Issue of Capital & Disclosure Requirements) Regulations, 2018 (as amended).

For, Abhishek Kumar & Associates
Chartered Accountants
 FRN: 130052W
 Peer Review Certificate No: 011266

Sd/-
CA Abhishek Agrawal
Proprietor
M. No.: 132305
Place: Ahmedabad
Date: July 20, 2024
UDIN: 24132305BKEYYX5316

ANNEXURE - A.1
RESTATED STATEMENT OF SHARE CAPITAL

(Amount in Lakhs except Units in Actual Numbers)

Particulars	As at		
	March 31,2024	March 31, 2023	March 31,2022
Share Capital			
Authorised Share Capital			
1,20,00,000 Equity Shares of Rs. 10 Each	1,200.00	50.00	0.00
(PY: 5,00,000 Equity Shares of Rs. 10 Each)			
Total	1,200.00	50.00	0.00
Issued, Subscribed & Fully Paid Up Share Capital			
80,00,000 Equity Shares of Rs. 10 Each	800.00	50.00	0.00
(PY: 5,00,000 Equity Shares of Rs. 10 Each)			
Total	800.00	50.00	0.00

ANNEXURE - A.1.1
RESTATED STATEMENT OF SHARE CAPITAL

(Amount in Rs. Lakhs)

Particulars	As at		
	March 31, 2024	March 31, 2023	March 31, 2022
Shareholders Fund			
Partner's Capital Account			
Prahladrai R Heda			
Opening Balance	0.00	356.67	215.21
Add : Fresh Capital introduced during the year	0.00	37.20	10.70
Less : Capital Withdrawn during the year	0.00	-323.70	25.24
Add : Interest on Capital	0.00	0.00	21.50
Add : Remuneration	0.00	0.00	28.00
Add : Profit from the firm	0.00	0.00	106.51
Less : Transfer to Unsecured Loan	0.00	-57.69	0.00
Total	0.00	12.48	356.67
Nitin Kumar Heda			
Opening Balance	0.00	466.53	183.01
Add : Fresh Capital introduced during the year	0.00	74.40	86.21
Less : Capital Withdrawn during the year	0.00	-443.21	113.93
Add : Interest on Capital	0.00	0.00	14.22
Add : Remuneration	0.00	0.00	84.00
Add : Profit from the firm	0.00	0.00	213.02
Less : Transfer to Unsecured Loan	0.00	-72.73	0.00
Total	0.00	24.99	466.53
Khushboo M Heda			
Opening Balance	0.00	335.38	223.96
Add : Fresh Capital introduced during the year	0.00	37.20	4.50
Less : Capital Withdrawn during the year	0.00	-345.02	21.84
Add : Interest on Capital	0.00	0.00	22.25
Add : Remuneration	0.00	0.00	0.00
Add : Profit from the firm	0.00	0.00	106.51
Less : Transfer to Unsecured Loan	0.00	-15.05	0.00
Total	0.00	12.51	335.38
Grand Total	0.00	49.98	1,158.58

A.1.2 Details of Shareholding more than 5% of the aggregate shares in the company:

Name of Shareholder	31-Mar-24		31-Mar-23		31-Mar-22	
	Nos	% of Holding	Nos	% of Holding	Nos	% of Holding
Nitinkumar Akshaykumar Heda	39,99,800	50.00	2,49,998	50.00	0	50.00
Prahladrai Ramdayal Heda	19,99,900	25.00	1,24,999	25.00	0	25.00
Khushboo Manishkumar Heda	19,99,900	25.00	1,24,999	25.00	0	25.00
Total	79,99,600	100.00	4,99,996	100.00	0	100.00

A.1.3 Shareholding of Promoters:

Name of Shareholder	31-Mar-24		31-Mar-23		31-Mar-22	
	Nos	% of Holding	Nos	% of Holding	Partner Capital	Profit Sharing ratio
Nitinkumar Akshaykumar Heda	39,99,800	50.00	2,49,998	50.00	0	50.00
Prahladrai Ramdayal Heda	19,99,900	25.00	1,24,999	25.00	0	25.00
Khushboo Manishkumar Heda	19,99,900	25.00	1,24,999	25.00	0	25.00
Manish Kumar Heda	-	-	-	-	0	-
Total	79,99,600	100.00	4,99,996	100.00	0	100.00

ANNEXURE – A.2**RESTATED STATEMENT OF RESERVES AND SURPLUS**

(Amount in Rs. Lakhs)

Particulars	As at		
	March 31, 2024	March 31, 2023	March 31, 2022
Reserves & Surplus			
1. Securities Premium			
Balance as at the beginning of the year	0.00	0.00	0.00
Addition during the year	71.60	0.00	0.00
Issued for Bonus Issue	0.00	0.00	0.00
Balance as at the end of the year	71.60	0.00	0.00
Balance in Statement of Profit & Loss			
Balance as at the beginning of the year	312.08	0.00	0.00
Add: Profit for the year	890.36	560.27	0.00
Add: Transfer to Reserves	0.00	0.00	0.00
Add/Less: Addition/(Deletion)	279.87	-248.19	0.00
Less: Equity shares issued during the year	350.00	0.00	0.00
Balance as at the end of the year	1,132.30	312.08	0.00
Grand Total	1,203.90	312.08	0.00

Note A.2.2:

- 1) The Company has been formed from conversion of Partnership firm into company vide a certificate of incorporation dated 04.08.2022. The company has been converted with paid up equity share capital of Rs. 50,00,000 divided into 5,00,000 equity shares of Rs. 10 each. The status of company prior to 04.08.2022 was that of Partnership Firm. Hence EPS, NAV per share of all years has been calculated by considering number of shares outstanding post conversion of Partnership Firm into company i.e. 5,00,000 Equity shares of Rs. 10 each.
- 2) The status of the company up to August 04, 2022 was Partnership Firm. For the purpose of Restated Financial Statements, the accounts of the Partnership Firm for the year ended on March 31, 2022 and for the period ended on August 25, 2022 have been forecasted in accordance with the requirements of Schedule III of the Companies Act, 2013. Thus Share Capital disclosed for these years represents Partners' Capital in the Partnership Firm.

ANNEXURE – A.3

RESTATED STATEMENT OF LONG-TERM BORROWINGS

(Amount in Rs. Lakhs)

Particulars	As at		
	March 31, 2024	March 31, 2023	March 31, 2022
Secured:			
From Bank:			
HDFC-Term Loan	624.20	727.86	966.42
Kotak Mahindra Car Loan	0.00	0.00	12.95
Less:			
Current Maturity of Long-Term Borrowings	-281.37	-253.58	-135.00
Unsecured:			
From Loans from Promoters/ Directors/ Promoters Group/ Associates/ Relative of Directors/ Group Companies	0.00	1,764.10	0.00
From Others	0.00	0.00	291.15
Total	342.83	2,238.38	1,135.52

Note A.3.1: There were no re-schedulement or default in the repayment of loans taken by the Company.

ANNEXURE – A.3.3
STATEMENT OF PRINCIPAL TERMS OF SECURED LOANS

(Amount in Rs. Lakhs)

Name of Lender	Purpose	Sanctioned Amount	Securities offered	Rate of Interest (P.A.)	Re-Payment Schedule	Moratorium	Outstanding amount as on (as per Books)		
							31.03.24	31.03.2023	31.03.2022
Axis Bank Cc Account - 923030046282100	Cash Credit	700.00	1) Hypothecation of entire current assets, both present and future on first pari passu basis with HDFC Bank 2) Residential Property - Radhe Residency, A-53, Vill Dumral, Nadiad Kheda - 387355, 2) Industrial property - Sr. No 52A, Tundel, Tal, Nadiad, Kheda 387320	8.90%	NA	NA	0.00	0.00	0.00
HDFC Cc A/C 50200073104369	Cash Credit	3500.00	1. STOCK, PERSONAL GUARANTEE OF ALL PARTNERS AND GUARANTOR, FIXED DEPOSIT, FIXED DEPOSIT FOR DSRA 2. RESIDENTIAL PROPERTY S P NO 10TP SCHEME NO 1 RESI - BUNGLOW FINAL PLOT NO 764S P NO 10 PRAHLAD NAGAR CO OP HOUSING SOCIETY OLD DUMRAL ROAD NADIAD - 387001387001 OLD DUMRAL ROAD 3. INDUSTRIAL PROPERTY BLOCK NO. 267/PRS NO 267/PAIKI 1 TOTAL ADM HEC 0-42-61BLOCK NO. 267/P, AT - DANTALI 387350, NATIONAL HIGHWAY NO. 8 4. INDUSTRIAL CUM COMMERCIAL BLOCK NO. 270/A, TAL. NADIAD, DIST KHEDAHEC 0-78-92, KHATA NO. 1163, CHHATA MILE, NH 8, VILLAGE DANTALI387350 CHHATAMILE 5. INDUSTRIAL CUM COMMERCIAL PROPERTY BLOCK NO 144-1 PLOT NO 3 TALUKA NADIAD, DIST. KHEDA, AT: TUNDEL,387320 N H NO 8 6. RESIDENCIAL D62 & E63, PRIME FLORA, NADIAD, KHEDA, GUJARAT - 387002.D62 & E63, PRIME FLORA, NEAR SANTRAM DERI,387001NEAR SANTRAM DERI	6.71%	NA	NA	2479.74	2154.86	0.00

Sunlite Recycling Industries Limited

HDFC Cc A/C 50200030044840	Cash Credit	1500.00	1. STOCK, PERSONAL GUARANTEE OF ALL PARTNERS AND GUARANTOR, FIXED DEPOSIT, FIXED DEPOSIT FOR DSRA 2. RESIDENTIAL PROPERTY S P NO 10TP SCHEME NO 1 RESI - BUNGLOW FINAL PLOT NO 764S P NO 10 PRAHLAD NAGAR CO OP HOUSING SOCIETY OLD DUMRAL ROAD NADIAD - 387001387001 OLD DUMRAL ROAD 3. INDUSTRIAL PROPERTY BLOCK NO. 267/PRS NO 267/PAIKI 1 TOTAL ADM HEC 0-42-61BLOCK NO. 267/P, AT - DANTALI 387350, NATIONAL HIGHWAY NO. 8 4. INDUSTRIAL CUM COMMERCIAL BLOCK NO. 270/A, TAL. NADIAD, DIST KHEDAHEC 0-78-92, KHATA NO. 1163, CHHATA MILE, NH 8, VILLAGE DANTALI387350 CHHATAMILE 5. INDUSTRIAL CUM COMMERCIAL PROPERTY BLOCK NO 144-1 PLOT NO 3 TALUKA NADIAD, DIST. KHEDA, AT: TUNDEL,387320 N H NO 8 6. RESIDENCIAL D62 & E63, PRIME FLORA, NADIAD, KHEDA, GUJARAT - 387002.D62 & E63, PRIME FLORA, NEAR SANTRAM DERI,387001NEAR SANTRAM DERI	7.25%	NA	NA	0.00	0.00	1261.86
HDFC Term Loan A/C No 451985244	Term Loan	225.59	Bbg-Wctl-Gecl Extn	9.25%	Repayable on monthly equitable instalment for 61 months.	NA	214.84	226.92	226.79
HDFC Term Loan A/C No 83815930	Term Loan	65.00	Bbg-Wc Term Loans	6.85%	Repayable on monthly equitable instalment for 59 months.	NA	0.26	15.94	30.57
HDFC Term Loan A/C No 84314647	Term Loan	610.53	Bbg-Wc Term Loans	6.85%	Repayable on monthly equitable	NA	198.58	325.44	444.73

Sunlite Recycling Industries Limited

					instalment for 67 months.					
HDFC Term Loan A/C No 85344486	Term Loan	100.00	Bbg-Wc Term Loans	6.85%	Repayable on monthly equitable instalment for 62 months.	NA	47.71	66.82	85.15	
HDFC Term Loan A/C No 8762893	Term Loan	114.00	Bbg-Wctl-Gecl	9.25%	Repayable on monthly equitable instalment for 49 months.	NA	25.44	64.53	100.32	
HDFC Term Loan A/C No 88130147	Term Loan	146.00	Bbg-Wc Term Loans	6.85%	Repayable on monthly equitable instalment for 62 months.	NA	133.33	0.00	0.00	
HDFC Term Loan A/C No 82956179	Term Loan	88.15	Bbg-Wc Term Loans	7.95%	Repayable on monthly equitable instalment for 58 months.	NA	0.00	0.00	20.55	
HDFC Term Loan A/C No 83128135	Term Loan	100.00	Bbg-Wc Term Loans	7.95%	Repayable on monthly equitable instalment for 68 months.	NA	0.00	16.45	39.36	
Kotak Mahindra Bank	Car Loan	18.06	Motor Vehicle Loan	7.70%	Repayable on monthly equitable instalment for 48 months.	NA	0.00	0.00	12.95	
HDFC Car Loan - 119290543	Car Loan	35.00	Motor Vehicle Loan	7.20%	Repayable on monthly equitable instalment for 39 months.	NA	4.04	11.76	18.93	
Total								3103.94	2882.72	2241.21

ANNEXURE – A.3.4-STATEMENT OF PRINCIPAL TERMS OF UNSECURED LOANS

(Amount in Lakhs except Units in Actual Numbers)

Name of Lender	Purpose	Sanctioned Amount	Securities offered	Rate of Interest (P.A.)	Re-Payment Schedule	Moratorium	Outstanding amount as on (as per Books)		
							31.03.24	31.03.2023	31.03.2022
Bangur Lata Ashishkumar	Business Loan	NIL	NIL	12%	On Demand	NA	0.00	0.00	26.96
Chandmal Somani	Business Loan	NIL	NIL	12%	On Demand	NA	0.00	0.00	2.70
Chandrika Manubhai Shah	Business Loan	NIL	NIL	12%	On Demand	NA	0.00	0.00	26.92
Chaturlal Khetsibhai Thakker	Business Loan	NIL	NIL	12%	On Demand	NA	0.00	0.00	5.42
Chauchan Vikrambhai J	Business Loan	NIL	NIL	12%	On Demand	NA	0.00	0.00	2.00
Dharmendrabhai S Sodha	Business Loan	NIL	NIL	12%	On Demand	NA	0.00	0.00	3.69
Kishan Dipchandbhai Thakkar	Business Loan	NIL	NIL	12%	On Demand	NA	0.00	0.00	5.42
Liladevi Jagdishchandra Bangur	Business Loan	NIL	NIL	12%	On Demand	NA	0.00	0.00	5.39
Manjula Devi Laddha	Business Loan	NIL	NIL	12%	On Demand	NA	0.00	0.00	15.96
Mukesh Jagdishchandra Bangur	Business Loan	NIL	NIL	12%	On Demand	NA	0.00	0.00	21.54
M V Shah HUF	Business Loan	NIL	NIL	12%	On Demand	NA	0.00	0.00	10.75
Omprakash Ambalal Mandowara	Business Loan	NIL	NIL	12%	On Demand	NA	0.00	0.00	1.61
Reena Rajiv Shah	Business Loan	NIL	NIL	12%	On Demand	NA	0.00	0.00	32.32
Shah Ankitkumar Mohanlal HUF	Business Loan	NIL	NIL	12%	On Demand	NA	0.00	0.00	23.46
Shah Bhartiben Ishwarbhai	Business Loan	NIL	NIL	12%	On Demand	NA	0.00	0.00	6.40
Shah Chintan Kirtibhai HUF	Business Loan	NIL	NIL	12%	On Demand	NA	0.00	0.00	16.14
Shah Ishwar Prabhulal	Business Loan	NIL	NIL	12%	On Demand	NA	0.00	0.00	3.00
Shah Kirtibhai Muljibhai HUF	Business Loan	NIL	NIL	12%	On Demand	NA	0.00	0.00	32.30
Shah Nimeshkumar Kirtibhai HUF	Business Loan	NIL	NIL	12%	On Demand	NA	0.00	0.00	32.30
Shweta Vikram Khoont	Business Loan	NIL	NIL	12%	On Demand	NA	0.00	0.00	16.87
Khushboo Manishkumar Heda	Business Loan	NIL	NIL	7%	On Demand	NA	0.00	770.26	0.00
Akshaykumar Ramdayal Heda	Business Loan	NIL	NIL	7%	On Demand	NA	0.00	0.21	0.00
Akshaykumar Ramdayal Heda HUF	Business Loan	NIL	NIL	7%	On Demand	NA	0.00	7.58	0.00
Manishkumar Akshaykumar Heda HUF	Business Loan	NIL	NIL	7%	On Demand	NA	0.00	7.58	0.00
Manish Kumar Heda	Business Loan	NIL	NIL	7%	On Demand	NA	0.00	5.31	0.00
Nitinkumar Akshyakumar Heda HUF	Business Loan	NIL	NIL	7%	On Demand	NA	0.00	7.58	0.00
Prahladrai Ramdayal Heda HUF	Business Loan	NIL	NIL	7%	On Demand	NA	0.00	7.58	0.00
Komal Heda	Business Loan	NIL	NIL	7%	On Demand	NA	0.00	101.17	0.00
Ladkumari Prahladrai Heda	Business Loan	NIL	NIL	7%	On Demand	NA	0.00	7.64	0.00
Nitin Kumar Heda	Business Loan	NIL	NIL	7%	On Demand	NA	0.00	420.71	0.00
Oxyzo Financial Services Private Limited Unsecured	Business Loan	NIL	NIL	15%	On Demand	NA	387.80	0.00	0.00
Prahladrai Ramdayal Heda	Business Loan	NIL	NIL	7%	On Demand	NA	0.00	427.20	0.00
Sharda Kumari Heda	Business Loan	NIL	NIL	7%	On Demand	NA	0.00	1.28	0.00
							387.80	1764.10	291.15

ANNEXURE – A.4
RESTATED STATEMENT OF LONG-TERM PROVISIONS

(Amount in Rs. Lakhs)

Particulars	March 31, 2024	March 31, 2023	March 31, 2022
Provision For Gratuity	4.71	3.71	2.28
Grand Total	4.71	3.71	2.28

ANNEXURE – A.5
RESTATED STATEMENT OF SHORT-TERM BORROWINGS

(Amount in Rs. Lakhs)

Particulars	As at		
	March 31, 2024	March 31, 2023	March 31, 2022
Secured:			
Working Capital Loans			
HDFC Bank - Cash Credit Account	2,479.74	2,154.86	1,261.86
AXIS Bank - Cash Credit Account	0.00	0.00	0.00
Current Maturity of Long Term Borrowings	281.37	253.58	135.00
Unsecured:			
From Loans from Promoters/ Directors/ Promoters Group/ Associates/ Relative of Directors/ Group Companies	0.00	0.00	0.00
From Others	387.80	0.00	0.00
Total	3,148.91	2,408.44	1,396.86

SUB ANNEXURE – A.5.1: AGEING OF RESTATED STATEMENT OF TRADE PAYABLES

(Amount in Rs. Lakhs)

Particulars	< 1 Year	1-2 Years	2-3 Years	More than 3 Years	Total
As at March 31, 2024					50.55
Trade Payables due to					
- Micro and Small Enterprises	0.80	-	-	-	0.80
- Others					
- Promotor/Promotor Group					
- Others	44.16	5.60	-	-	49.75
As at March 31, 2023					1,603.99
Trade Payables due to					
- Micro and Small Enterprises	436.62	-	-	-	436.62
- Others					
- Promotor/Promotor Group					
- Others	1,167.37	-	-	-	1,167.37
As at March 31, 2022					847.10
Trade Payables due to					
- Micro and Small Enterprises	188.31	-	-	-	188.31
- Others					
- Promotor/Promotor Group					
- Others	642.11	13.66	-	3.02	658.79

ANNEXURE – A.6
RESTATED STATEMENT OF TRADE PAYABLES

(Amount in Rs. Lakhs)

Particulars	As at		
	March 31, 2024	March 31, 2023	March 31, 2022
Trade Payables due to			
- Micro and Small Enterprises	0.80	436.62	188.31
- Others			
- Promotor/Promotor Group	0.00	0.00	0.00
- Others	49.75	1,167.37	658.79
Total	50.55	1,603.99	847.10

Note A.6.1: Trade Payable due from Invoice date to others are subject to Third Party Confirmation.

ANNEXURE – A.7
RESTATED STATEMENT OF OTHER CURRENT LIABILITIES

(Amount in Rs. Lakhs)

Particulars	As at		
	March 31, 2024	March 31, 2023	March 31, 2022
Statutory Payables	201.20	63.80	24.15
Payable to Employees	7.66	8.40	4.09
Provision for Expenses	0.00	0.00	0.00
Other Payables (Interest on USL)	0.00	0.00	0.00
Advance Received	0.00	0.00	0.00
Advance from Trade Receivables			
Others	188.80	205.01	2.61
Grand Total	397.66	277.21	30.85

ANNEXURE – A.8
RESTATED STATEMENT OF SHORT-TERM PROVISIONS

(Amount in Rs. Lakhs)

Particulars	As at		
	March 31, 2024	March 31, 2023	March 31, 2022
Expenses Payable	15.36	0.00	10.31
Provision For Gratuity	0.33	0.11	0.00
Provision for Income Tax	297.18	204.31	148.12
Provision for Audit Fees	4.00	1.00	0.00
Grand Total	316.87	205.42	158.43

*Provision for Income Tax is calculated in Statement of Tax Shelter considering the Allowance & Disallowance of Income & Expenditure in the Income Tax Return filed by the company.

ANNEXURE – A.8.1
RESTATED STATEMENT OF PROVISION FOR GRATUITY

(Amount in Rs. Lakhs)

Particulars	As at		
	March 31, 2024	March 31, 2023	March 31, 2022
Provision For Gratuity	1.23	1.53	1.52
Grand Total	1.23	1.53	1.52

ANNEXURE – A.9
RESTATED STATEMENT OF PROPERTY, PLANT AND EQUIPMENT

(Amount in Rs. Lakhs)

As At 31.03.24

Particulars	Gross Block				Accumulated Depreciation				Net Block	
	As at March 31, 2023	Additions	Deletion/Sale	As at March 31, 2024	As at March 31, 2023	Depreciation charge for the year	Deletion-Sale/Loss	As at March 31, 2024	As at March 31, 2024	As at March 31, 2023
A. Property Plant & Equipment										
Land & Building	383.09	26.50	0.00	409.59	60.88	24.88	0.00	85.76	323.83	322.21
Furniture and Fixtures	5.71	3.76	0.00	9.47	2.75	1.26	0.00	4.01	5.47	2.97
Office Equipments	1.82	1.17	0.00	2.99	0.20	0.78	0.00	0.98	2.01	1.62
Electrical Installations & Equipments	0.00	180.00	0.00	180.00	0.00	19.66	0.00	19.66	160.34	0.00
Plant & Machinery	1,836.85	51.85	32.39	1,856.31	776.94	195.38	8.39	963.93	892.38	1,059.91
End User Devices - Laptop	3.79	2.23	0.00	6.02	2.68	1.30	0.00	3.98	2.04	1.11
Total Tangible Assets	2,231.27	265.51	32.39	2,464.39	843.45	243.26	8.39	1,078.32	1,386.07	1,387.82
B. Intangible Assets										
Software & Services	0.00	0.00	0.00	0.00	0.00	0.00	0.00	0.00	0.00	0.00
Total Intangible Assets	0.00	0.00	0.00	0.00	0.00	0.00	0.00	0.00	0.00	0.00
Grand Total	2,231.27	265.51	32.39	2,464.39	843.45	243.26	8.39	1,078.32	1,386.07	1,387.82

As At 31.03.2023

Particulars	Gross Block				Accumulated Depreciation				Net Block	
	Balance as at August 25, 2022	Additions	Deletion/Sale	As at March 31, 2023	Balance as at August 25, 2022	Depreciation charge for the year till March 31, 2022	Deletion-Sale/Loss	As at March 31, 2023	As at March 31, 2023	As at August 25, 2022
A. Property Plant & Equipment										
Land & Building	373.69	9.40	0.00	383.09	46.05	14.83	0.00	60.88	322.21	327.64
Furniture and Fixtures	5.71	0.00	0.00	5.71	2.13	0.62	0.00	2.75	2.97	3.59
Office Equipments	0.00	1.82	0.00	1.82	0.00	0.20	0.00	0.20	1.62	0.00
Electrical Installations & Equipments	0.00	0.00	0.00	0.00	0.00	0.00	0.00	0.00	0.00	0.00
Plant & Machinery	1,811.64	25.21	0.00	1,836.85	650.52	126.42	0.00	776.94	1,059.91	1,161.12
End User Devices - Laptop	3.09	0.70	0.00	3.79	1.91	0.77	0.00	2.68	1.11	1.18
Total Tangible Assets	2,194.14	37.13	0.00	2,231.27	700.61	142.84	0.00	843.45	1,387.82	1,493.53
B. Intangible Assets										
Software & Services	0.00	0.00	0.00	0.00	0.00	0.00	0.00	0.00	0.00	0.00
Total Intangible Assets	0.00	0.00	0.00	0.00	0.00	0.00	0.00	0.00	0.00	0.00
Grand Total	2,194.14	37.13	0.00	2,231.27	700.61	142.84	0.00	843.45	1,387.82	1,493.53

Sunlite Recycling Industries Limited

As At 25.08.2022

Particulars	Gross Block				Accumulated Depreciation			Net Block		
	As at March 31, 2022	Additions	Deletion /Sale	Balance as at August 25, 2022	As at March 31, 2022	Depreciation charge for the period	Adjustments/ Deletion-Sale/Loss	Balance as at August 25, 2022	As at August 25, 2022	Balance as at March 31, 2022
A. Property Plant & Equipment										
Land & Building	169.68	204.01	0.00	373.69	36.05	10.00	0.00	46.05	327.64	133.63
Furniture and Fixtures	5.71	0.00	0.00	5.71	1.71	0.42	0.00	2.13	3.59	4.01
Office Equipments	0.00	0.00	0.00	0.00	0.00	0.00	0.00	0.00	0.00	0.00
Electrical Installations & Equipments	0.00	0.00	0.00	0.00	0.00	0.00	0.00	0.00	0.00	0.00
Plant & Machinery	1,543.93	267.71	0.00	1,811.64	565.14	85.38	0.00	650.52	1,161.12	978.79
End USER Devices-Laptop	3.09	0.00	0.00	3.09	1.39	0.52	0.00	1.91	1.18	1.70
Capital WIP	216.52	0.00	216.52	0.00	0.00	0.00	0.00	0.00	0.00	216.51
Total Tangible Assets	1,938.94	471.72	216.52	2,194.14	604.29	96.32	0.00	700.61	1,493.53	1,334.64
B. Intangible Assets										
Software & Services	0.00	0.00	0.00	0.00	0.00	0.00	0.00	0.00	0.00	0.00
Total Intangible Assets	0.00	0.00	0.00	0.00	0.00	0.00	0.00	0.00	0.00	0.00
Grand Total	1,938.94	471.72	216.52	2,194.14	604.29	96.32	0.00	700.61	1,493.53	1,334.64

As At 31.03.2022

Particulars	Gross Block				Accumulated Depreciation			Net Block		
	Balance as at April 1, 2021	Additions	Deletion/ Sale	Balance as at March 31, 2022	Balance as at April 1, 2021	Depreciation charge for the period	Deletion-Sale/Loss	Balance as at March 31, 2022	Balance as at March 31, 2022	Balance as at March 31, 2021
A. Property Plant & Equipment										
Land & Building	166.09	3.59	0.00	169.68	22.34	13.71	0.00	36.05	133.63	143.75
Furniture and Fixtures	2.60	3.11	0.00	5.71	0.58	1.13	0.00	1.71	4.01	2.03
Plant & Machinery	1,367.09	176.84	0.00	1,543.93	360.70	204.44	0.00	565.14	978.79	1,006.39
End USER Devices-Laptop	1.07	2.02	0.00	3.09	0.69	0.70	0.00	1.39	1.70	0.38
Capital WIP	93.85	122.66	0.00	216.51	0.00	0.00	0.00	0.00	216.51	93.85
Total Tangible Assets	1,630.71	308.22	0.00	1,938.93	384.31	219.98	0.00	604.29	1,334.64	1,246.40
B. Intangible Assets										
Software & Services	0.00	0.00	0.00	0.00	0.00	0.00	0.00	0.00	0.00	0.00
Total Intangible Assets	0.00	0.00	0.00	0.00	0.00	0.00	0.00	0.00	0.00	0.00
Grand Total	1,630.71	308.22	0.00	1,938.93	384.31	219.98	0.00	604.29	1,334.64	1,246.40

ANNEXURE – A.10
RESTATED STATEMENT OF NON-CURRENT INVESTMENTS

(Amount in Rs. Lakhs)

Particulars	As at		
	March 31, 2024	March 31, 2023	March 31, 2022
Quoted Securities and Investments			
Securities	0.00	0.00	0.00
Grand Total	0.00	0.00	0.00

ANNEXURE – A.11
RESTATED STATEMENT OF DEFERRED TAX (ASSETS)/LIABILITIES (NET)

(Amount in Rs. Lakhs)

Particulars	As at		
	March 31, 2024	March 31, 2023	March 31, 2022
Deferred Tax Liability			
Related to Fixed Assets	54.54	62.37	71.85
Related to Stamp Duty / Gratuity Provisions	1.27	0.96	0.57
Total (a)	55.81	63.33	72.42
Deferred Tax Assets			
Related to Fixed Assets	0.00	0.00	0.00
Total (b)	0.00	0.00	0.00
Net Deferred Tax (Asset)/Liability [(b)-(a)]	55.81	63.33	72.42

ANNEXURE – A.12
RESTATED STATEMENT OF LONG TERM LOANS & ADVANCES

(Amount in Rs. Lakhs)

Particulars	As at		
	March 31, 2024	March 31, 2023	March 31, 2022
Deposits			
CST Deposit	0.00	0.00	0.10
Sarvam Petroleum Deposit	0.00	0.00	0.00
MSTC Deposit	0.00	0.00	0.10
VAT Deposit	0.00	0.00	0.10
Grand Total	0.00	0.00	0.30

ANNEXURE – A.13
RESTATED STATEMENT OF OTHER NON-CURRENT ASSETS

(Amount in Rs. Lakhs)

Particulars	As at		
	March 31, 2024	March 31, 2023	March 31, 2022
Security Deposits	25.82	84.17	48.44
Grand Total	25.82	84.17	48.44

ANNEXURE – A.14
RESTATED STATEMENT OF INVENTORIES

(Amount in Rs. Lakhs)

Particulars	As at		
	March 31, 2024	March 31, 2023	March 31, 2022
Closing Stock Raw Material	1,697.38	3,256.67	2,156.40
Closing Stock WIP	306.14	493.63	199.58
Closing Stock of Finished Goods	904.44	68.94	4.54
Stores, Spares & Packing Materials	61.60	56.43	44.02
Grand Total	2,969.56	3,875.67	2,404.54

* Closing Stock is physically verified, reconciled with the stock records & Certified by the management at the end of the reporting period.

ANNEXURE – A.15: RESTATED STATEMENT OF TRADE RECEIVABLES

(Amount in Rs. Lakhs)

Particulars	As at		
	March 31, 2024	March 31, 2023	March 31, 2022
Outstanding for a period exceeding six months (Unsecured and considered Good)			
-From Directors/Promoters/Promoter Group/Associates/ Relatives of Directors/ Group Companies.	0.00	0.00	0.00
-Others	41.29	41.63	39.68
Outstanding for a period not exceeding 6 months (Unsecured and considered Good)			
-From Directors/Promoters/Promoter Group/Associates/ Relatives of Directors/ Group Companies.	0.00	0.00	0.00
-Others	1,381.11	1,126.12	465.67
Grand Total	1,422.40	1,167.75	505.35

* Trade Receivables are subject to Third Party Confirmation

SUB ANNEXURE – A.15.1: AGEING OF RESTATED STATEMENT OF TRADE RECEIVABLES

(Amount in Rs. Lakhs)

Particulars	< 6 Months	6 to 12 Months	1-2 Years	2-3 Years	More than 3 Years	Total
As at March 31, 2024	1,381.11	41.29	-	-	-	1,422.40
From Directors/Promoters/Promoter Group/Associates/ Relatives of Directors/ Group Companies.	-	-	-	-	-	-
Others	1,381.11	41.29	-	-	-	1,422.40
As at March 31, 2023	1,126.12	41.63	-	-	-	1,167.75
From Directors/Promoters/Promoter Group/Associates/ Relatives of Directors/ Group Companies.	-	-	-	-	-	-
Others	1,126.12	41.63	-	-	-	1,167.75
As at March 31, 2022	465.67	2.97	18.77	15.21	2.73	505.35
From Directors/Promoters/Promoter Group/Associates/ Relatives of Directors/ Group Companies.	-	-	-	-	-	-
Others	465.67	2.97	18.77	15.21	2.73	505.35

ANNEXURE – A.16: RESTATED STATEMENT OF CASH AND CASH EQUIVALENTS

(Amount in Rs. Lakhs)

Particulars	As at		
	March 31, 2024	March 31, 2023	March 31, 2022
Cash & Cash Equivalents			
Cash in hand	6.79	3.37	4.08
Balances with Banks:			
In Current Accounts	0.55	199.85	0.69
In Deposits Accounts	0.00	0.00	0.00
Grand Total	7.34	203.22	4.77

ANNEXURE – A.17: RESTATED STATEMENT OF SHORT-TERM LOANS AND ADVANCES

(Amount in Rs. lakhs)

Particulars	As at		
	March 31, 2024	March 31, 2023	March 31, 2022
(i) Balance with Government Authorities	162.12	122.93	299.63
(ii) Others (specify nature)			
Advance recoverable in cash or kind	0.00	0.00	0.00
Staff Advance	0.39	0.53	0.00
Grand Total	162.51	123.46	299.63

ANNEXURE – A.18: RESTATED STATEMENT OF OTHER CURRENT ASSETS

(Amount in Rs. Lakhs)

Particulars	As at		
	March 31, 2024	March 31, 2023	March 31, 2022
Advance Income Tax	200.00	0.00	110.00
Prepaid Expenses	10.34	1.69	11.22
Advance to Trade Payables			
MSME	0.00	0.00	0.00
Others	137.20	318.78	83.17
Grand Total	347.54	320.47	204.39

ANNEXURE – B.1: RESTATED STATEMENT OF REVENUE FROM OPERATIONS

(Amount in Rs. Lakhs)

Particulars	For the year ended		
	March 31, 2024	March 31, 2023	March 31, 2022
Revenue from operations			
Export	0.00	545.05	707.98
Sales of Manufactured Goods	0.00	545.05	707.98
Domestic	1,16,627.09	1,14,473.83	93,011.34
Sales of Manufactured Goods	1,14,292.21	1,12,594.97	92,088.26
Sales of Traded Goods	1,934.22	1,584.00	704.10
Job Work Income & Miscellaneous Items	400.66	294.87	218.98
Grand Total	1,16,627.09	1,15,018.88	93,719.32

ANNEXURE – B.2: RESTATED STATEMENT OF OTHER INCOME

(Amount in Rs. Lakhs)

Particulars	For the year ended		
	March 31, 2024	March 31, 2023	March 31, 2022
Rent Income	18.00	10.85	0.00
Interest on It Refund	3.62	0.55	0.00
Interest Income - Term Deposit	6.38	2.61	63.36
Duty Drawback	0.00	7.02	9.12
Grand Total	28.00	21.03	72.48

ANNEXURE – B.3: RESTATED STATEMENT OF COST OF MATERIALS CONSUMED

(Amount in Rs. Lakhs)

Particulars	For the year ended		
	March 31, 2024	March 31, 2023	March 31, 2022
Raw Material at the beginning of the year	3,256.67	2,156.40	884.35
Add: Purchases of Raw Material During the Period	1,08,580.06	1,10,896.16	91,342.20
Add: Purchases of Packing Material During the Period	41.80	57.40	32.11

Add: Purchases of Stores & Spares During the Period	332.11	244.40	188.39
Less: Raw Material at the end of the year	1,697.38	3,256.67	2,156.40
Cost of Materials consumed	1,10,513.26	1,10,097.69	90,290.65

ANNEXURE – B.3.1: RESTATED STATEMENT OF PURCHASE OF STOCK-IN-TRADE

(Amount in Rs. Lakhs)

Particulars	For the year ended		
	March 31, 2024	March 31, 2023	March 31, 2022
Purchases During the year	1,934.21	1,553.49	693.04
Grand Total	1,934.21	1,553.49	693.04

ANNEXURE – B.4: RESTATED STATEMENT OF CHANGE IN INVENTORIES OF WIP, FINISHED GOODS OR STOCK IN TRADE

(Amount in Rs. Lakhs)

Particulars	For the year ended		
	March 31, 2024	March 31, 2023	March 31, 2022
(A) Work in Progress			
Opening Work-in-Progress	493.63	199.58	169.15
Less: Closing Work-in-Progress	306.14	493.63	199.58
Total (A)	187.49	-294.05	-30.43
(B) Finished Goods			
Opening of Finished Goods	68.94	4.54	6.10
Less: Closing of Finished Goods	904.44	68.94	4.54
Total (B)	-835.50	-64.40	1.56
(C) Packing Material			
Opening of Stock-in-Trade	56.43	44.02	37.52
Less: Closing of Stock-in-Trade	61.60	56.43	44.02
Total (C)	-5.17	-12.41	-6.50
Total Changes in Inventories of Finished Goods, Work-in-Progress and Packing Material	-653.18	-370.86	-35.37

ANNEXURE – B.5: RESTATED STATEMENT OF EMPLOYEE BENEFIT EXPENSE

(Amount in Rs. Lakhs)

Particulars	For the year ended		
	March 31, 2024	March 31, 2023	March 31, 2022
Salaries, Wages and Incentives	127.79	115.02	44.05
Provident Fund	0.79	0.77	0.00
Staff Welfare Expense (Gratuity)	1.23	1.65	0.00
Director /Partner Remunerations	120.00	112.00	112.00
Grand Total	249.81	229.44	156.05

ANNEXURE – B.6: RESTATED STATEMENT OF FINANCE COSTS

(Amount in Rs. Lakhs)

Particulars	For the year ended		
	March 31, 2024	March 31, 2023	March 31, 2022
Bank Charges	5.01	0.55	0.54
Interest Expenses	440.80	449.26	278.72
Loan Processing Fees & Other Charges	22.42	22.95	11.53
Grand Total	468.23	472.76	290.79

ANNEXURE – B.7: RESTATED STATEMENT OF DEPRECIATION & AMORTIZATION

(Amount in Rs. Lakhs)

Particulars	For the year ended		
	March 31, 2024	March 31, 2023	March 31, 2022
Depreciation	243.26	239.16	219.98
Grand Total	243.26	239.16	219.98

ANNEXURE – B.8: RESTATED STATEMENT OF OTHER EXPENSES

(Amount in Rs. Lakhs)

Particulars	For the year ended		
	March 31, 2024	March 31, 2023	March 31, 2022
Direct Expenses			
Custom Duty Expenses	849.21	317.11	31.24
Freight Expenses	43.27	21.66	39.01
Factory Expenses	0.35	1.26	0.56
Import Expenses	139.56	52.88	4.82
Power & Fuel Expenses	1,073.89	1,108.43	883.44
Labor & Job Charges Expenses	101.25	84.13	113.60
Indirect Expenses			
Audit Fees	2.75	1.30	0.32
Advertisement & Marketing Expenses	7.74	1.76	1.02
Discount & Kasar Vatav	0.25	-1.79	16.93
Foreign Currency Rate Difference	39.14	15.39	7.17
Freight & Loading & Unloading Expenses	284.65	287.95	292.37
Legal & Professional Fees Expenses	52.82	71.71	64.13
Tax & Rates Expenses	14.35	0.37	0.32
Insurance Expenses	11.58	26.75	19.84
Commission Charges	33.98	20.93	35.21
Office Expenses	3.75	2.92	2.07
Registration & Membership Fees Expenses	0.76	0.32	0.51
Security Charges	5.17	4.76	4.04
Rent Expenses	20.66	19.65	9.60
Repair & Maintenance Expenses	14.49	22.02	81.03
Stationery and Printing Expenses	7.51	3.23	4.90
Bad debts	12.36	0.00	0.00
Grand Total	2,719.49	2,062.74	1,612.13

ANNEXURE – B.9: RESTATED STATEMENT OF DEFERRED TAX (ASSETS)/LIABILITIES

(Amount in Rs. Lakhs)

Particulars	For the year ended		
	March 31, 2024	March 31, 2023	March 31, 2022
WDV as per Companies Act, 2013 (A)	1,386.07	1,387.82	1,334.64
WDV as per Income tax Act, 1961 (B)	1,169.65	1,140.31	1,126.38
Difference in WDV (A-B)	216.42	247.51	208.26
Deferred Tax (Asset)/ Liability '(C)	54.54	62.37	71.85
Gratuity as per Companies Act	5.04	3.82	2.28
Gratuity as per Income Tax Act	0.00	0.00	0.00
Difference (D-E)	5.04	3.82	2.28
Deferred Tax (Asset)/ Liability '(F)	1.27	0.96	0.57
Restated Closing Balance of Deferred Tax (Asset)/ Liability	55.81	63.33	72.42
Deferred Tax (Assets)/ Liability as per Balance sheet of Previous Year	63.33	72.42	82.04
Deferred Tax (Assets)/ Liability charged to Profit & Loss	-7.53	-9.09	-9.62

ANNEXURE - F: RESTATED STATEMENT OF TAX SHELTERS

(Amount in Rs. Lakhs)

Sr. No	Particulars	For the year ended		
		March 31, 2024	March 31, 2023	March 31, 2022
A	Restated Profit before tax	1,180.01	755.49	564.53
	Short Term Capital Gain at special rate	0.00	0.00	0.00
	Normal Corporate Tax Rates (%)	25.168%	25.168%	25.168%
	Short Term Capital Gain at special rate			
	MAT Tax Rates (%)	Not Applicable as Opted for 115BAA	Not Applicable as Opted for 115BAA	Not Applicable as Opted for 115BAA
B	Tax thereon (including surcharge and education cess)			
	Tax on normal profits	296.99	190.14	142.08
	Short Term Capital Gain at special rate	0.00	0.00	0.00
	Total	296.99	190.14	142.08
	Adjustments:			
C	Permanent Differences			
	Allowance of Expenses under the Income Tax Act Section 35	0.00	0.00	0.00
	Disallowance of Income under the Income Tax Act	0.00	0.00	0.00
	Disallowance of Expenses under the Income Tax Act	0.00	0.00	0.00
	Total Permanent Differences	0.00	0.00	0.00
D	Timing Differences			
	Difference between Depreciation as per Income tax, 1961 and Companies Act 2013	-5.82	-60.12	-26.28
	Provision for Gratuity disallowed	5.04	3.82	2.28
	Expense disallowed u/s 43B	0.00	0.00	0.00
	Total Timing Differences	-0.78	-56.30	-24.00
E	Net Adjustments E= (C+D)	-0.78	-56.30	-24.00
F	Tax expense/(saving) thereon	-0.20	-14.17	-6.04
G	Total Income/(loss) (A+E)	1,179.23	699.19	540.53
	Taxable Income/ (Loss) as per MAT	1,180.01	755.49	564.53
I	Income Tax as per normal provision	297.18	204.31	148.12
J	Income Tax under Minimum Alternative Tax under Section 115 JB of the Income Tax Act	NA	NA	NA
	Net Tax Expenses	297.18	204.31	148.12
K	Relief u/s 90/91	0.00	0.00	0.00
	Total Current Tax Expenses	297.18	204.31	148.12
L	Adjustment for Interest on income tax/ others	0.00	0.00	0.00
	Total Current Tax Expenses	297.18	204.31	148.12

ANNEXURE - G: RESTATED STATEMENT OF CAPITALISATION

(Amount in Rs. Lakhs)

Sr. No	Particulars	Pre issue	Post issue*
	Debts		
A	Long Term Debt*	624.20	444.20
B	Short Term Debt*	2,867.54	1467.54
C	Total Debt	3,491.74	1911.74
	Equity Shareholders Funds		
	Equity Share Capital	800.00	1088.00
	Reserves and Surplus	1,203.90	3939.90
D	Total Equity	2,003.90	5027.90
	Long Term Debt/ Equity Ratio (A/D)	0.31	0.09
	Total Debt/ Equity Ratio (C/D)	1.74	0.38

Notes:

1. The figures disclosed above are based on restated statement of Assets and Liabilities of the Company as at 31/03/2024.
2. Short term Debts represent which are expected to be paid/payable within 12 months and excludes instalment of term loans repayable within 12 months.
3. Long term Debts represent debts other than short term Debts as defined above but includes instalment of term loans repayable within 12 months grouped under other current liabilities.

*The corresponding post issue figures are not determinable at this stage pending the completion of public issue and hence have not been furnished.

ANNEXURE - H: RESTATED STATEMENT OF CONTINGENT LIABILITIES

(Amount in Rs. Lakhs)

Particulars	As at		
	March 31, 2024	March 31, 2023	March 31, 2022
1. LC Discounting for which FDR margin money has been given to the bank as Security	0.00	0.00	0.00
2. Capital Commitment	0.00	0.00	0.00
3. Income Tax Demand	0.00	0.00	0.00
4. TDS Demands	1.63	0.00	0.00
5. GST Demand	1,492.51	0.00	0.00
6. Guarantees given on Behalf of the Company	222.02	222.02	0.00
Total	1,716.16	222.02	0.00

ANNEXURE - I: RESTATED STATEMENT OF MANDATORY ACCOUNTING RATIOS

(Amount in Rs. Lakhs)

Particulars	As at		
	March 31, 2024	March 31, 2023	March 31, 2022
Restated PAT as per P& L Account	890.36	560.27	426.03
EBITDA	1,836.07	1,422.88	990.75
Actual No. of Equity Shares outstanding at the end of the period **	80.00	5.00	5.00
Weighted Average Number of Equity Shares at the end of the Period (Note -2) **	46.01	40.00	40.00
Net Worth	2,003.90	362.08	1,158.58
Current Assets	4,909.35	5,690.57	3,418.68
Current Liabilities	3,913.99	4,495.06	2,433.24
Earnings Per Share			
EPS {Basic/Diluted} (Post Bonus)	19.35	14.01	10.65
Return on Net Worth (%)	44.43%	154.74%	36.77%
Net Asset Value Per Share			
Based on actual number of shares	25.05	72.42	231.72
Based on Weighted average number of shares	43.55	9.05	28.96
Current Ratio	1.25	1.27	1.40
EBITDA	1,836.07	1,422.88	990.75
Nominal Value per Equity share (Rs.)	10.00	10.00	10.00

* The Company does not have any diluted potential Equity Shares. Consequently, the basic and diluted profit/earning per share of the company remain the same.

** Units are in division of Lakhs for the purpose of Ratio calculations.

Our Company was incorporated by conversion from erstwhile firm Sunlite Industries on August 04, 2022. Therefore, no. of shares outstanding in above table are taken as the weighted average no. of shares of the company so formed after conversion for all the years. The company has prepared its financial statements up to August 25, 2022, ensuring operational continuity.

Notes:

- 1) The ratios have been calculated as below:
 - a) Basic Earnings Per Share (Rs.) = Restated PAT attributable to Equity Shareholders/ Weighted Average Number of Equity Shares outstanding during the year.
 - b) Diluted Earnings Per Share (Rs.) = Restated PAT attributable to Equity Shareholders/ Weighted Average Number of Diluted Potential Equity Shares outstanding during the year.
 - c) Return on Net Worth (%) = Restated PAT attributable to Equity Shareholders/ Net Worth X 100
 - d) Restated Net Asset Value per equity share (Rs.) = Restated Net Worth as at the end of the year/ Total Number of Equity Shares outstanding during the year.
- 2) Weighted Average Number of equity shares is the number of equity shares outstanding at the beginning of the year adjusted by the number of equity shares issued during the year multiplied by the time weighting factor. Further, number of shares are after considering impact of the bonus shares.
- 3) Earnings Per Share calculation are in accordance with Accounting Standard 20- Earnings Per Share, notified under the Companies (Accounting Standards) Rules 2006, as amended.
- 4) Net Worth = Equity Share Capital + Reserve and Surplus (including surplus in the Statement of Profit & Loss) - Preliminary Expenses to the extent not written-off.
- 5) The figures disclosed above are based on the Restated Financial Statements of the Company.

ANNEXURE – J: RESTATED STATEMENT OF RELATED PARTY DISCLOSURES

As required under Accounting Standard 18 "Related Party Disclosures" as notified pursuant to Company (Accounting Standard) Rules 2006, following are details of transactions during the year with related parties of the company as defined in AS 18.

ii. List of Related Parties and Nature of Relationship:

Particulars	Name of Related Parties	Nature of Relationship
a) Key Management Personnel's / Related Party	Nitinkumar Akshaykumar Heda	Managing Director
	Prahladrai Ramdayal Heda	Chairman & Whole Time Director
	Khushboo Manishkumar Heda	Non-Executive Director
	Ronak Ashokbhai Mehta	Independent Director
	Jaimish Govindbhai patel	Independent Director
	Nikita Sharma	Company Secretary
	Manish Heda	Chief Financial Officer
b) Associate Concerns	Komal Heda	Wife of Nitin kumar Heda
	Heda ladmumari Prahladrai	Wife of Prahladrai Ramdayal Heda
c) Enterprises in which KMP/Relatives of KMP can exercise significant influence	Santram Metals And Alloys Private Limited	Nitin Kumar Heda having controlling interest
	Sunlite Aluminium Private Limited	Manish Heda having controlling interest
	Heda Sanghatan Seva Foundation	Prahladrai Ramdayal Heda having controlling interest
	Nitinkumar Akshaykumar Heda HUF	HUF of our KMP
	Heda Prahladrai Ramdayal (HUF)	HUF of our KMP
	Heda Akshaykumar Ramdayal (HUF)	HUF of our KMP's relative
	Manishkumar Akshaykumar Heda (HUF)	HUF of our KMP

(Amount in Rs. lakhs)

Nature of Transactions	Name of Related Parties	As at March 31, 2024	As at March 31, 2023	As at March 31, 2022
1. Partners Remuneration	Nitin Kumar Heda	0.00	0.00	84.00
	Prahladrai Ramdayal Heda	0.00	0.00	28.00
2. Directors Remuneration	Nitin Kumar Heda	90.00	66.00	0.00
	Prahladrai Ramdayal Heda	30.00	22.00	0.00
3. Interest	Akshaykumar Heda	0.00	0.23	18.22

	Heda Akshaykumar R HUF	0.00	0.09	5.17
	Manishkumar A Heda HUF	0.00	0.09	2.87
	Manish Kumar Heda	0.60	0.35	3.13
	Nitinkumar A Heda HUF	0.22	0.09	2.79
	Pratik Satishbhai Shah	0.00	0.00	0.99
	Reena P Heda	1.99	0.00	1.90
	Khushboo Manishkumar Heda	44.26	51.30	0.00
	Nitin Heda	47.95	74.91	0.00
	Prahladrai R Heda	28.27	29.25	0.00
	Prahladrai Ramdayal Heda HUF	0.22	0.00	0.00
	Shardakumari Heda	1.87	0.00	0.00
	Komal Heda	10.17	0.00	0.00
	Ladkumari Prahaladbhai Heda	1.84	0.00	0.00
3. Rent	Nitin Kumar Heda	16.80	16.80	9.60
4.Labour Contract	Akshaykumar Heda	0.00	0.00	10.08
5. Salary	Manish Kumar Heda	48.02	32.02	36.02
	Pratik Satishbhai Shah	0.00	3.22	4.22
6. Interest On Capital	Khushboo Manishkumar Heda	0.00	0.00	22.25
	Nitin Heda	0.00	0.00	14.22
	Prahladrai R Heda	0.00	0.00	21.50
7. Loan Received (Paid) during the Year to Related Parties	Akshaykumar Heda			
	Opening Balance	0.21	0.00	148.61
	Loan Received during the year	44.79	31.23	120.92
	Loan Paid during the year	-45.00	-31.02	-269.52
	Closing Balance	0.00	0.21	0.00
	Chandmal Somani			
	Opening Balance	0.00	0.00	2.70
	Loan Received during the year	0.00	0.00	0.00
	Loan Paid during the year	0.00	0.00	0.00
	Closing Balance	0.00	0.00	2.70
	Heda Akshaykumar R HUF			
	Opening Balance	7.58	0.00	37.97
	Loan Received during the year	61.24	11.09	21.17
	Loan Paid during the year	-68.82	-3.51	-59.15
	Closing Balance	0.00	7.58	0.00
	Heda Prahladrai R HUF			
	Opening Balance	7.58	0.00	26.98
	Loan Received during the year	0.20	15.09	18.93
	Loan Paid during the year	-7.78	-7.51	-45.91
	Closing Balance	0.00	7.58	0.00
	Komal Heda			
	Opening Balance	101.17	0.00	78.95
	Loan Received during the year	66.15	112.88	40.87
	Loan Paid during the year	-167.32	-11.71	-119.82
	Closing Balance	0.00	101.17	0.00
	LADKUMARI HEDA			
	Opening Balance	7.64	0.00	4.94
	Loan Received during the year	29.81	8.65	11.14
	Loan Paid during the year	-37.45	-1.01	-16.09
	Closing Balance	0.00	7.64	0.00
	Manishkumar A Heda HUF			
	Opening Balance	7.58	0.00	18.25
	Loan Received during the year	0.20	11.09	19.87
	Loan Paid during the year	-7.78	-3.51	-38.12
	Closing Balance	0.00	7.58	0.00
	Manish Kumar Heda			

	Opening Balance	5.31	0.00	44.79
	Loan Received during the year	58.24	10.35	35.04
	Loan Paid during the year	-63.55	-5.03	-79.83
	Closing Balance	0.00	5.31	0.00
	Nitinkumar A Heda HUF			
	Opening Balance	7.58	0.00	18.13
	Loan Received during the year	0.20	11.09	18.79
	Loan Paid during the year	-7.78	-3.51	-36.92
	Closing Balance	0.00	7.58	0.00
	Pratik Satishbhai Shah			
	Opening Balance	0.00	0.00	8.16
	Loan Received during the year	0.00	0.00	4.99
	Loan Paid during the year	0.00	0.00	-13.15
	Closing Balance	0.00	0.00	0.00
	Reena P Heda			
	Opening Balance	0.00	0.00	14.25
	Loan Received during the year	35.44	1.00	12.75
	Loan Paid during the year	-35.44	-1.00	-27.00
	Closing Balance	0.00	0.00	0.00
	Shardaben A Heda			
	Opening Balance	1.29	0.00	46.84
	Loan Received during the year	51.87	4.79	39.01
	Loan Paid during the year	-53.16	-3.50	-85.85
	Closing Balance	0.00	1.29	0.00
	Khushboo Manishkumar Heda			
	Opening Balance	758.58	745.92	0.00
	Loan Received during the year	48.33	95.10	0.00
	Loan Paid during the year	-806.91	-82.45	0.00
	Closing Balance	0.00	758.58	0.00
	Nitin Heda			
	Opening Balance	397.36	1,075.46	0.00
	Loan Received during the year	740.64	262.71	0.00
	Loan Paid during the year	-1,138.00	-940.82	0.00
	Closing Balance	0.00	397.36	0.00
	Prahladrai R Heda			
	Opening Balance	415.52	424.48	0.00
	Loan Received during the year	107.74	29.25	0.00
	Loan Paid during the year	-523.26	-38.21	0.00
	Closing Balance	0.00	415.52	0.00
8. Sales	Sunlite Aluminium Pvt Ltd	15.27	0.00	0.00
9. Purchase	Adarsh Impex	0.00	1,486.34	63.80
10. Rent Income	Sunlite Aluminium Pvt Ltd	18.00	0.00	0.00
11. Job work	Sunlite Aluminium Pvt Ltd	30.26	0.00	0.00

ANNEXURE-K
RATIO ANALYSIS AND ITS ELEMENTS

(Rs. in Lakhs Except Per Share Data)

Particulars	Note	31-03-2024	31-03-2023	31-03-2022	Variation between FY 24 & FY 23	Variation between FY 23 & FY 22	Reason for Variation between FY 24 & FY 23	Reason for Variation between FY 23 & FY 22
Current Ratio (times)	1	1.25	1.27	1.40	-9.90%	2.41%	N.A.	N.A.
Debt Equity Ratio (times)	2	1.74	12.83	2.19	487.16%	-20.54%	As the capital in the form of Bonus issue and Rights issue has been infused in the business by the members, the debt equity ratio has been reduced from 9.75 times in F.Y. 2022-23 to 1.87 in F.Y. 2023-24 by 80.80%.	N.A.
Debt Service Coverage Ratio (times)	3	2.54	2.02	2.39	-15.46%	3.56%	N.A.	N.A.
Return On Equity Ratio (%)	4	75.26 %	73.69 %	47.85 %	54.00%	-2.52%	The Company has issued the bonus shares and right shares to its Shareholders and as a result of such issues the paid-up capital of the company increases from Rs 50.00 Lacs to Rs 8.00 Crore and hence the return on equity has been decreased from 161.65% in the F.Y. 2022-23 to 76.80% in the F.Y 2023-24 by 52.80% decrease.	N.A.
Inventory Turnover ratio(times)	5	32.66	35.44	51.95	-31.78%	9.35%	A higher inventory turnover ratio has increased in line with increase in sales turnover of the company.	N.A.
Trade Receivable Turnover Ratio(times)	6	90.05	137.49	158.31	-13.15%	168.17%	N.A.	Trade Receivable Turnover Ratio is increased due to increase in the preceding period due to non-realization of Credit Sales as on the closing of financial.
Trade Payable Turnover Ratio(times)	7	133.59	91.75	93.07	-1.41%	109.37%	N.A.	Trade Payable Turnover Ratio is Increased due to Increase In purchases.

Sunlite Recycling Industries Limited

Net Capital Turnover Ratio(times)	8	106.47	105.48	113.96	-7.44%	54.59%	N.A.	Net Capital Turnover Ratio Increased due to increase in sales Compare to increase in Average working capital.
Net Profit Ratio (%)	9	0.76%	0.49%	0.45%	7.16%	-29.10%	N.A.	Return on Capital Employed is Decreased significantly because sales are increased & other fixed overheads are also increased more than that proportion
Return on Capital Employed (%)	10	29.49 %	24.05 %	22.85 %	5.28%	-7.78%	N.A.	N.A.
Return on investment (%)	11	25.64 %	16.82 %	17.56 %	-4.21%	13.70%	N.A.	N.A.

OTHER FINANCIAL INFORMATION

The Audited Financial Statements of our Company as at March 31 2024, March 31, 2023 and March 31, 2022 and their respective Audit reports thereon (Audited Financial Statements) are available at www.sunliteindustries.com

Our Company is providing a link to this website solely to comply with the requirements specified in the Securities and Exchange Board of India (Issue of Capital and Disclosure Requirement) Regulations, 2018. The Audited Financial Statements do not constitute, (i) a part of this Draft Red Herring Prospectus; or (ii) Red Herring Prospectus; or (iii) prospectus, a statement in lieu of a prospectus, an advertisement, an offer or a solicitation of any offer or an offer document to purchase or sell any securities under the Companies Act, 2013, the Securities and Exchange Board of India (Issue of Capital and Disclosure Requirement) Regulations, 2018, or any other applicable law in India or elsewhere in the world. The Audited Financial Statements should not be considered as part of information that any investor should consider subscribing for or purchase any securities of our Company and should not be relied upon or used as a basis for any investment decision. Neither our Company, nor BRLM, nor any of their respective Employees, Directors, Affiliates, Agents or representatives accept any liability whatsoever for any loss, direct or indirect, arising from any information presented or contained in the Audited Financial Statements, or the opinions expressed therein.

The accounting ratios required under Clause 11 of Part A of Schedule VI of the SEBI (ICDR) Regulations are given below: -

(Rs. In Lakhs except percentages and ratios)

Particulars	For the year ended		
	March 31, 2024	March 31, 2023	March 31, 2022
Profit After Tax (Rs. In Lakhs)	890.36	560.27	426.03
Basic & Diluted Earnings per Share	19.35	14.01	10.65
Return on Net Worth (%)	44.43%	154.74%	36.77%
NAV per Equity Shares (Based on Actual Number of Shares)	25.05	72.42	231.72
NAV per Equity Shares (based on Weighted Average Number of Shares - With Bonus issue effect)	43.55	9.05	28.96
Earnings before interest, tax, depreciation and amortization (EBITDA)	1,836.07	1,422.88	990.75

STATEMENT OF FINANCIAL INDEBTEDNESS

To,
The Board of Directors,
Sunlite Recycling Industries Limited
(Formerly known as Sunlite Alucop Private Limited)
Survey No. 270A & Plot No. 1 Survey No. 267,
Chhatha Mile, Dantali, Vaso, Kheda -387350, Gujarat, India.

Dear Sir,

Based on the independent examination of Books of Accounts, Audited Financial Statements and other documents of **Sunlite Recycling Industries Limited** and further explanations and information provided by the management of the Company, which we believe to be true and correct to the best of our information and belief, the sanction amount of financial indebtedness, principal terms of security for loan and other related details as on March 31, 2024 are mentioned below.

A. SECURED LOANS

STATEMENT OF PRINCIPAL TERMS OF SECURED LOANS AND ASSETS CHARGED AS SECURITY

Name of Lender	Purpose	Loan Reference No.	Sanctioned Amount (Rs. In Lakhs)	Rate of interest (P.A)	Primary & Collateral Security	Re-Payment Schedule	Outstanding amount as on 31.03.2024 (Rs. In Lakhs)
HDFC Bank Ltd.	GECLGS Loan	451985244	225.59	9.25%	Secured against personal guarantee of directors, extension of charges on primary/collateral security	Repayable on monthly equitable installment for 61 months. Interest payment only for first 24 installments and afterwards 36 installments of Rs.7.10 lakhs each and last installment of Rs. 4.36 lakhs.	214.84
HDFC Bank Ltd.	WC Term Loans	83815930	24.37	9.75%	Secured against personal guarantee of directors, extension of charges on primary/collateral security	Repayable on monthly equitable installment for 58 months of Rs. 1.37 lakhs each and last installment of Rs. 0.26 lakhs	0.26
HDFC Bank Ltd.	WC Term Loans	84314647	392.81	9.71%	Secured against personal guarantee of directors, extension of charges on primary/collateral security	Repayable on monthly installment for 67 months of Rs. 12.58 lakh.	198.58

HDFC Bank Ltd.	WC Term Loans	85344486	76.89	9.75%	Secured against personal guarantee of directors, extension of charges on primary/collateral security	Repayable on monthly installment for 62 months of Rs. 2.03 lakh	47.71
HDFC Bank Ltd.	GECLGS Loan	8762893	114.00	9.25%	Secured against personal guarantee of directors, extension of charges on primary/collateral security	Repayable on monthly installment for 49 months of Rs.3.59 lakh. Interest payment only for first 12 installments and afterwards installments of Rs.3.59 lakhs each for 36 months and last installment of Rs. 1.17 lakhs.	25.44
HDFC Bank Ltd.	WC Term Loans	88130147	300.00	10.02%	Secured against personal guarantee of directors, extension of charges on primary/collateral security	Repayable on monthly installment for 62 months of Rs. 2.86 lakhs	133.33
HDFC Bank Ltd.	Car Loan	119290543	24.00	7.20%	Against vehicle	Repayable on monthly equitable installment for 39 months of Rs. 0.69 lakh each	4.04
HDFC Bank Ltd.	WCDL Facility	88536780	3500.00	8.63%	Note 1	Repayable on Demand	2479.74
TOTAL (Fund Based)							3103.94
TOTAL (Non-Fund Based)							2424.00
GRAND TOTAL (Fund and Non fund Based)							5527.94

Note 1:

Primary Security: Debtors, Fixed Deposit, LC from Other Bank, Personal Guarantee of All Directors and Guarantor, Stock

Assets on which exclusive charge in created:

- Block No 144-1, Taluka Nadiad, Dist Kheda Plot No.3, at tundel, NH 8, Dantali Gujarat-454618 owned by ladben prahladray shah
- Factory Land and Building at survey No.271,272/1, tal. vaso chhatha mile, village dantali, vaso, Gujarat-387380 owned by Nitin Akshay Heda
- Industrial property block no. 267/prs no 267/paiki 1 total adm hec 0-42-61block no. 267/p, at - dantali 387350, N.H. no. 8, nadiad Gujarat-387002 owned by Nitin Kumar Akshay Kumar heda
- Industrial cum commercial block no. 270/a, tal. Nadiad, dist. Kheda hec 0-78-92, Khata no. 1163, chhata mile, NH 8, village dantali387350 chhata mile, Kheda Gujarat, 387610 owned by Nitin Kumar Akshay Kumar heda
- S.P. No. 10 TP Scheme No 1 Final Plot NO 764 S P No 10 Prahlad Nagar Co-op housing society Old Dumral Road Nadiad 387001 owned by Prahladrai Ramdayal heda

6. Residential D62 & E63, prime flora, nadiad, Kheda, Gujarat - 387002.d62 & e63, prime flora, near santram deri,387001near santram Deri, Gujarat-387001 owned by Reena Pankaj Kumar and Pankaj Kumar P Heda

B. UNSECURED LOANS

Name of Lender	Purpose	Rate of Interest (P.A)	31-03-2024 (Rs. In Lakhs)
Oyzyo Financial Services Private Limited	Business Loan	15%	387.80
Total			387.80

For, Abhishek Kumar & Associates

Chartered Accountants,

FRN: 130052W

Sd/-

Abhishek Agrawal

Proprietor

Membership No: 132305

Place: Ahmedabad

Date: July 20, 2024

UDIN: 24132305BKEYVW3444

MANAGEMENT'S DISCUSSION AND ANALYSIS OF FINANCIAL CONDITIONS AND RESULTS OF OPERATIONS

You should read the following discussion in conjunction with our restated financial statements attached in the chapter titled "Financial Information of the Company" beginning on page 144. You should also read the section titled "Risk Factors" on page 25 and the section titled "Forward Looking Statements" on page 18 of this Prospectus, which discusses a number of factors and contingencies that could affect our financial condition and results of operations. The following discussion relates to us, and, unless otherwise stated or the context requires otherwise, is based on our Restated Financial Statements.

Our financial statements have been prepared in accordance with Indian GAAP, the Companies Act and the SEBI (ICDR) Regulations and restated as described in the report of our auditor dated July 20, 2024, which is included in this Prospectus under "Financial Statements". The Restated Financial Information has been prepared on a basis that differs in certain material respects from generally accepted accounting principles in other jurisdictions, including US GAAP and IFRS. Our financial year ends on March 31 of each year, and all references to a particular financial year are to the twelve-month period ended March 31 of that year.

OVERVIEW:

We are engaged in the business of manufacturing of copper rods & wires, copper earthing wires, copper earthing strips, copper conductors, copper wire bars etc. through recycling of copper scrap, which has electrical and mechanical properties suitable for applications in power generation, transmission, distribution and electronic industries. Further, we are also engaged in providing job work services for processing of various products of copper, wherein our customers provide us with the copper scrap and we are converting the copper scrap into copper wire and copper wire rod as per customer's requirement. We employ an internal quality control mechanism to ensure that our finished product conforms to the exact requirement of our customers.

Our promoter, Prahladrai Ramdayal Heda, established a proprietorship concern in the name of 'M/s Sunlite Industries' in 2012, engaged in manufacturing copper rods, wires, bars, strips etc. In September 2017, with the aim of expanding the scope and enhancing business administration, Prahladrai Ramdayal Heda decided to include our other two promoters, Nitin Kumar Heda and Khushboo Manishkumar Heda, as partners and established Partnership firm in the name of "M/s. Sunlite Industries". Said partnership firm got registered on October 28, 2017 having registration number GUJVA200549 and the business operations continued as a partnership firm till August 2022. Later, the said partnership concern was converted into a private limited company in August 2022, with the objective of carrying on the business of the aforementioned partnership concern as a going concern under the name of Sunlite Alucop Private Limited bearing Corporate Identification Number U27200GJ2022PTC134540 and subsequently, in January 2024, the company changed its name from Sunlite Alucop Private Limited to Sunlite Recycling Industries Private Limited.

We currently operate through our Registered office and manufacturing unit situated at Survey No. 270A and Plot No 1 of Survey No 267, Chhatamile, Tal. Vaso, Dantali, Kheda, 387350 Gujarat, India with a total area of approx. 12,152 sq. mtr. We started our business operations in 2012 as a proprietorship concern and manufacturing only one product i.e. oxygen-free copper rods. Later in year 2015-16, we expanded our area of operation by developing one more shed and installing copper strip machine with an installed capacity of 350 MT, which was imported from China, thereby started manufacturing of copper strips along with copper rods. Then in year 2017-18, we purchased wire-drawing machine and started manufacturing of copper wire. Subsequently, after entering into the partnership firm to expand our business operations, we purchased Copper CCR Machine in year 2020, with resulted into a significant surge in our revenue from operations. As on the date of this Prospectus, we have a total of 20 machines to manufacture wide range of copper products.

Our Product Portfolio offers a diversified product range which includes variety of grades, thickness, widths and standards, in all types of copper products according to customer specifications. We prioritize environmental and safety considerations in our copper production process. Our approach involves recycling copper scrap utilizing electricity sourced from solar generation and clean natural gas, thus mitigating the pollution associated with conventional oil-based energy sources. Copper is one of the most recycled metals of all the metals. The recycling of copper scrap is gaining importance worldwide simply because of the fact that recovery of copper metal from scrap requires much less energy than its recovery made from primary source. Besides, it enables conservation of natural resources. (Source: Indian Bureau of Mines).

Our Company is managed by our Promoters - Prahladrai Ramdayal Heda, Nitin Kumar Heda, Khushboo Manishkumar Heda and Manish Kumar Heda. Prahladrai Ramdayal Heda (chairman and whole-time director of the company and Partner of erstwhile M/s Sunlite Industries) is responsible for quality control, process improvement, Operations & Management, HR & administration. He ventured into the business of manufacturing of copper rods in year 2012 and since then, he has gained a good knowledge and experience of 15 years in this industry. Nitin Kumar Heda (Managing Director of the company and partner of erstwhile M/s Sunlite

Industries) who has approx. 17 years of experience in same industry, is responsible for financial aspects of the company along with marketing, vendor management, business planning and development. Khushboo Manishkumar Heda (Non-Executive Director of the company and partner of erstwhile M/s Sunlite Industries) has approx. 06 years of experience in same industry. Manish Kumar Heda (Chief Financial Officer of the company and employee of erstwhile M/s Sunlite Industries) has approx. 15 years of experience in same industry, is responsible for financial activities of the company including finance, statutory compliance, business development, Sales & Marketing, general operations, customer relations management of the Company. Their understanding of the consumer difficulty, intuitive entrepreneurship and involvement in key aspects of our business has helped accelerate and drive our profitable growth. We believe that the sector-specific experience and expertise of our promoters has contributed significantly in the growth of our Company.

We have a strong track record of revenue growth and profitability. The following table sets forth certain key performance indicators for the years indicated:

(Rs. In Lakhs except percentages and ratios)

Key Financial Performance	For the financial year ended		
	March 31, 2024	March 31, 2023	March 31, 2022
Revenue from Operations ⁽¹⁾	1,16,627.09	1,15,018.88	93,719.32
EBITDA ⁽²⁾	1,836.07	1,422.88	990.75
EBITDA Margin ⁽³⁾	1.57%	1.24%	1.06%
Profit After Tax (PAT) ⁽⁴⁾	890.36	560.27	426.03
PAT Margin ⁽⁵⁾	0.76%	0.49%	0.45%
ROE ⁽⁶⁾	75.26%	73.69%	47.85%
ROCE ⁽⁷⁾	29.49%	24.05%	22.85%
Net Worth ⁽⁸⁾	2,003.90	362.08	1,158.58

Notes:

⁽¹⁾ Revenue from Operations means the Revenue from Operations as appearing in the Restated Financial Statements.

⁽²⁾ EBITDA is calculated as Profit before tax + Depreciation + Interest Cost – Other Income

⁽³⁾ 'EBITDA Margin' is calculated as EBITDA divided by Revenue from Operations

⁽⁴⁾ PAT is calculated as Profit before tax – Tax Expenses

⁽⁵⁾ PAT Margin' is calculated as PAT for the year divided by revenue from operations.

⁽⁶⁾ Return on Equity is ratio of Profit after Tax and Shareholder Equity

⁽⁷⁾ Return on Capital Employed is calculated as EBIT divided by capital employed, which is defined as shareholders' equity plus total borrowings {current & non-current}.

⁽⁸⁾ Net Worth = Equity Share Capital + Reserve and Surplus (including surplus in the Statement of Profit & Loss) - Preliminary Expenses to the extent not written-off.

Explanation for KPI metrics

KPI	Explanations
Revenue from Operations	Revenue from Operations is used by our management to track the revenue profile of the business and in turn helps to assess the overall financial performance of our Company and volume of our business
EBITDA	EBITDA provides information regarding the operational efficiency of the business
EBITDA Margin (%)	EBITDA Margin (%) is an indicator of the operational profitability and financial performance of our business
PAT	Profit after tax provides information regarding the overall profitability of the business.
PAT Margin (%)	PAT Margin (%) is an indicator of the overall profitability and financial performance of our business.
RoE (%)	RoE provides how efficiently our Company generates profits from shareholders' funds.
RoCE (%)	RoCE provides how efficiently our Company generates earnings from the capital employed in the business.

STATEMENT OF SIGNIFICANT ACCOUNTING POLICIES

For details in respect of Statement of Significant Accounting Policies, please refer to Restated Financial Statements beginning on page 144 of this Prospectus.

Factors Affecting our Results of Operations

1. General economic and business conditions in the markets in which we operate and in the local, regional, national and international economies;
2. Changes in consumer demand;

3. Failure to successfully upgrade our product portfolio, from time to time;
4. Any change in government policies resulting in increases in taxes payable by us;
5. Our ability to successfully implement strategy, growth and expansion plans and technological initiatives;
6. Our ability to retain our key managements persons and other employees;
7. Changes in laws and regulations that apply to the industries in which we operate.
8. Our failure to keep pace with rapid changes in technology;
9. Our ability to grow our business;
10. Our ability to make interest and principal payments on our existing debt obligations and satisfy the other covenants contained in our existing debt agreements;
11. general economic, political and other risks that are out of our control;
12. Inflation, deflation, unanticipated turbulence in interest rates, equity prices or other rates or prices;
13. Company's ability to successfully implement its growth strategy and expansion plans;
14. failure to comply with regulations prescribed by authorities of the jurisdictions in which we operate;
15. inability to successfully obtain registrations in a timely manner or at all;
16. occurrence of Environmental Problems & Uninsured Losses;
17. conflicts of interest with affiliated companies, the promoter group and other related parties;
18. any adverse outcome in the legal proceedings in which we are involved;
19. Concentration of ownership among our Promoter;
20. The performance of the financial markets in India and globally;
21. Global distress due to pandemic, war or by any other reason.

Discussion on Result of Operations

The following discussion on results of operations should be read in conjunction with the Restated Financial Statements for the financial years ended March 31 2024, March 31, 2023 and March 31, 2022.

(₹ in Lakhs)

	For the financial year ended					
	FY 2023-24	% of Total Income	FY 2022-23	% of Total Income	FY 2021-22	% of Total Income
Income						
Revenue From Operation	1,16,627.09	99.98	1,15,018.88	99.98	93,719.32	99.92
Other Income	28.00	0.02	21.03	0.02	72.48	0.08
Total Income	1,16,655.09	100.00	1,15,039.91	100.00	93,791.80	100.00
Expenditure						
Cost of Material Consumed	1,10,513.26	94.74	1,10,097.69	95.70	90,290.65	96.27
Purchases of Stock in Trade	1,934.21	1.66	1,553.49	1.35	693.04	0.74
Changes in inventories of WIP, Packing material & finished goods.	-653.18	-0.56	-370.86	-0.32	-35.37	-0.04
Employee Benefit Expenses	249.81	0.21	229.44	0.20	156.05	0.17
Finance Cost	468.23	0.40	472.76	0.41	290.79	0.31
Depreciation and Amortization Expenses	243.26	0.21	239.16	0.21	219.98	0.23
Other Expenses	2,719.49	2.33	2,062.74	1.79	1,612.13	1.72
Total Expenditure	1,15,475.08	98.99	1,14,284.42	99.34	93,227.27	99.40
Profit/(Loss) Before Exceptional & extraordinary items & Tax	1,180.01	1.01	755.49	0.66	564.53	0.60
Exceptional Item	-		-		-	
Profit/(Loss) Before Tax	1,180.01	1.01	755.49	0.66	564.53	0.60
Tax Expense:						
Tax Expense for Current Year	297.18	0.25	204.31	0.18	148.12	0.16
Deferred Tax	-7.53	-0.01	-9.09	-0.01	-9.62	-0.01
Net Current Tax Expenses	289.66	0.25	195.22	0.17	138.50	0.15
Profit/(Loss) for the Year	890.36	0.76	560.27	0.49	426.03	0.45

Revenue from operations:

We are a copper manufacturing industry, primarily engaged in the business of manufacturing of copper rods & wires, copper earthing wires, copper earthing strips, copper conductors, copper wire bars etc., which has electrical and mechanical properties suitable for applications in power generation, transmission, distribution and electronic industries.

Other Income:

Our other income primarily comprises of Rent Income & Interest Income.

Expenses:

Company's expenses consist of cost of material consumed, Purchase of Stock-in-trade, Change in Inventories, employee benefit expenses, finance cost, depreciation and amortization expenses and other expenses

Cost of Goods Sold:

Our cost of goods sold comprises of purchase of raw Material, purchase of packing material, purchase of stores & spares, purchase of stock-in-trade and change in inventories of raw material, WIP, packing material and finished goods.

Employee benefits expense:

Our employee benefits expense primarily comprises of Salaries, wages, incentive and Director's Remuneration and other funds.

Finance Costs:

Our finance cost includes Interest on loan paid to Bank and other parties and other borrowing costs like bank charges, loan processing fees etc.

Depreciation and Amortization Expenses:

Depreciation includes depreciation on Property, Plant & Equipments, furniture & fixtures, office equipments etc.

Other Expenses:

Our other expenses include custom duty, freight expenses, import expenses, power & fuel, labour & job charges, advertisement & marketing expenses, legal & professional fees, office expenses, security charges, rent expenses, repair & maintenance expenses etc.

For the year ended March 31, 2024 (Based on Restated Financial Statements)

Total Income:

Total income for the year ending March 31, 2024 stood at Rs. 1,16,655.09 Lakhs.

Revenue from Operations:

During the year ending March 31, 2024 revenue from operations stood at Rs. 1,16,627.09 Lakhs.

Other Income:

During the year ending March 31, 2024 , other income was Rs 28.00 Lakhs.

Total Expenses:

The Total Expenses for the year ending March 31, 2024 stood at Rs. 1,15,475.08 Lakhs.

Cost of material consumed:

During the year ending March 31, 2024 , cost of material consumed stood at Rs. 1,10,513.26 lakhs.

Purchase of stock-in-trade:

During the year ending March 31, 2024 , purchase of stock in trade comprises of Rs. 1,934.21 lakhs.

Changes in inventories of WIP, packing material & finished goods:

During the year ending March 31, 2024 , there was a change in inventory of Rs. (653.18) lakhs

Employee benefits expense:

Our Company has incurred Rs. 249.81 Lakhs as Employee benefits expense for the year ending March 31, 2024 .

Finance costs:

Finance costs for the year ending March 31, 2024 was Rs. 468.23 Lakhs.

Depreciation and Amortization Expenses:

Depreciation the year ending March 31, 2024 was Rs. 243.26 Lakhs.

Other Expenses:

Other Expenses the year ending March 31, 2024 stood at Rs. 2719.49 Lakhs.

Restated Profit before tax:

The Company reported Restated profit before tax the year ending March 31, 2024 of Rs. 1180.01 Lakhs.

Restated profit after tax:

The Company reported Restated profit after tax for the the year ending March 31, 2024 of Rs. 890.36 Lakhs.

In FY 2023-24, PAT margin of the company has increased mainly due to decrease in cost of material consumed. Total cost of material consumed was 96.75% of total revenue from operations in FY 2022-23, which has now decreased to 95.86% of total revenue from operations in FY 2023-24. Such decrease in cost was mainly on account of increase in import purchases, where, we got materials like Copper scrap birch cliff, Copper scrap telly birch, Copper scrap berry candy etc. at low cost compared to the domestic market. Till March 31, 2024 company had an import purchase of material up to 27.31% of total purchases which was only 0.90% and 9.34% of total purchases in F.Y. 2021-22 and 2022-23 respectively. This resulted into lower cost and higher PAT margin.

Financial Year 2024 Compared to Financial Year 2023 (Based on Restated Financial Statements)

Total Income:

Total income for the financial year 2023-24 stood at Rs. 1,16,655.09 Lakhs whereas in Financial Year 2022-23 the same stood at Rs. 1,15,039.91 Lakhs representing an increase of 1.40%. The main reason for increase in total income was due to increase in the sale of our products, majorly due to increase in sale of copper rods from Rs. 1,02,706.31 lakhs in FY 2022-23 to Rs. 1,04,562.48 lakhs in FY 2023-24, representing an increase of 1.81% and increase in sale of copper strips from Rs. 1,658.08 lakhs in FY 2022-23 to Rs. 2266.71 lakhs in FY 2023-24 representing an increase of 36.71%.

Revenue from Operations

During the financial year 2023-24, the net revenue from operation of our Company increased to Rs. 1,16,627.09 Lakhs as against Rs. 1,15,018.88 Lakhs in the Financial Year 2022-23 representing an increase of 1.40%. The main reason for increase in total revenue was due to increase in sale of copper rods from Rs. 1,02,706.31 lakhs in FY 2022-23 to Rs. 1,04,562.48 lakhs in FY 2023-

24, representing an increase of 1.81% and increase in sale of copper strips from Rs. 1,658.08 lakhs in FY 2022-23 to Rs. 2266.71 lakhs in FY 2023-24 representing an increase of 36.71%.

Other Income:

During the financial year 2023-24, the other income of our Company increased to Rs. 28.00 Lakhs as against Rs. 21.03 lakhs in the Financial Year 2022-23 representing an increase of 33.14%. The increase in other income was majorly due to increase in interest income and rent income.

Total Expenses

The total expense for the financial year 2023-24 increased to Rs. 115475.08 Lakhs from Rs. 114284.42 lakhs in the Financial Year 2022-23 representing an increase of 1.04%. Such increase was due to increase in business operations of the Company like increase in employee benefit expenses from Rs. 229.44 lakhs in Fiscal 2023 to Rs. 249.81 Lakhs in Fiscal 2024 representing an increase of 8.88% and increase in other expenses from Rs. 2062.74 lakhs in fiscal 2023 to Rs. 2719.49 lakhs in fiscal 2024 representing an increase of 31.84% as compared with previous year.

Cost of goods sold

There was slight increase in Cost of goods to Rs. 111794.29 lakhs in F.Y 2023-24 from Rs. 111280.32 lakhs in F.Y 2022-23 representing increase of 0.46% which is in line with increase in sale of our products.

Employee benefits expense:

Our Company has incurred Rs. 249.81 Lakhs as Employee benefits expense during the financial year 2023-24 as compared to Rs. 229.44 Lakhs in the financial year 2022-23. The increase of 8.88% was mainly due to increase in salary, wages & incentive expense.

Finance costs:

These costs were for the financial Year 2023-24 decreased to Rs. 468.23 Lakhs as against Rs. 472.76 Lakhs during the financial year 2022-23. The decrease of 0.96% was due to decrease in the borrowings. The increase in borrowing cost was attributable due to decrease in borrowings of the company to Rs. 3491.74 lakhs in fiscal 2024 from Rs. 4646.82 lakhs in fiscal 2023.

Depreciation and Amortization Expenses:

Depreciation for the financial year 2023-24 stood at Rs. 243.26 Lakhs as against Rs. 239.16 Lakhs during the financial year 2022-23. The increase in depreciation was around 1.71% in comparison to the previous year.

Other Expenses:

Our Company has incurred Rs. 2719.49 Lakhs during the Financial Year 2023-24 on other expenses as against Rs. 2062.74 Lakhs during the financial year 2022-23. There was an increase of 31.84% mainly due to increase in expenses like custom duty expenses, import expenses, power & fuel expenses, Advertisement & Marketing expenses etc.

Restated profit before tax:

Net profit before tax for the financial year 2023-24 increased to Rs. 1180.01 Lakhs as compared to Rs. 755.49 Lakhs in the financial year 2022-23, which was majorly due to factors as mentioned above.

Restated profit for the year:

The Company reported Restated profit after tax for the financial year 2023-24 of Rs. 890.36 Lakhs in comparison to Rs. 560.27 lakhs in the financial year 2022-23. The increase of 58.92% was majorly due to factors mentioned above.

In FY 2023-24, PAT margin of the company has increased mainly due to decrease in cost of material consumed. Total cost of material consumed was 96.75% of total revenue from operations in FY 2022-23, which has now decreased to 95.86% of total revenue from operations in FY 2023-24. Such decrease in cost was mainly on account of increase in import purchases, where, we got materials like Copper scrap birch cliff, Copper scrap telly birch, Copper scrap berry candy etc. at low cost compared to the domestic market. Till March 31, 2024 company had an import purchase of material up to 27.31% of total purchases which was

only 0.90% and 9.34% of total purchases in F.Y. 2021-22 and 2022-23 respectively. This resulted into lower cost and higher PAT margin.

Financial Year 2023 Compared to Financial Year 2022 (Based on Restated Financial Statements)

Total Income:

Total income for the financial year 2022-23 stood at Rs. 1,15,039.91 Lakhs whereas in Financial Year 2021-22 the same stood at Rs. 93,791.80 Lakhs representing an increase of 22.65%. The main reason for increase in total income was due to increase in the sale of our products, majorly due to increase in sale of copper rods from Rs. 83,209.07 lakhs in FY 2021-22 to Rs. 1,02,706.31 lakhs in FY 2022-23, representing an increase of 23.43% and increase in sale of copper wires from Rs. 6,667.98 lakhs in FY 2021-22 to Rs. 8,335.16 lakhs in FY 2022-23 representing an increase of 25.00%.

Revenue from Operations

During the financial year 2022-23, the net revenue from operation of our Company increased to Rs. 115018.88 Lakhs as against Rs. 93719.32 Lakhs in the Financial Year 2021-22 representing an increase of 22.73%. The main reason for increase in total income was due to increase in the sale of our products, majorly due to increase in sale of copper rods from Rs. 83,209.07 lakhs in FY 2021-22 to Rs. 1,02,706.31 lakhs in FY 2022-23, representing an increase of 23.43% and increase in sale of copper wires from Rs. 6,667.98 lakhs in FY 2021-22 to Rs. 8,335.16 lakhs in FY 2022-23 representing an increase of 25.00%.

Other Income:

During the financial year 2022-23, the other income of our Company decreased to Rs. 21.03 Lakhs as against Rs. 72.48 lakhs in the Financial Year 2021-22 representing a decrease of 70.99%. The decrease in other income was majorly due to decrease in interest income.

Total Expenses

The total expense for the financial year 2022-23 increased to Rs. 114284.42 Lakhs from Rs. 93227.27 lakhs in the Financial Year 2021-22 representing an increase of 22.59%. Such increase was due to increase in business operations of the Company. The cost of goods sold increased from Rs. 90,948.32 lakhs in Fiscal 2022 to Rs. 1,11,280.32 lakhs in Fiscal 2023 representing an increase of 22.36%, increase in employee benefit expenses from Rs. 156.05 lakhs to Rs. 229.44 Lakhs representing an increase of 47.03%, increase in finance cost from Rs. 290.79 Lakhs in Fiscal 2022 to Rs. 472.76 Lakhs in Fiscal 2023 representing an increase of 62.58% and increase in other expenses from Rs. 1612.13 lakhs in fiscal 2022 to Rs. 2062.74 lakhs in fiscal 2023 representing an increase of 27.95% as compared with previous year.

Cost of goods sold

Cost of goods increased to Rs. 1,11,280.32 lakhs in F.Y 2022-23 from Rs. 90,948.32 lakhs in F.Y 2021-22 representing increase of 22.36%. Such increase was due to increase in business operations of the Company. Total purchases of raw-material, packing material, stores & spares and purchase of stock in trade increased from Rs.92255.74 lakhs in FY 2021-22 to Rs. 112751.45 lakhs in FY 2022-23 representing an increase of 22.22% which is in line with increase in sale of our products.

Employee benefits expense:

Our Company has incurred Rs. 229.44 Lakhs as Employee benefits expense during the financial year 2022-23 as compared to Rs. 156.05 Lakhs in the financial year 2021-22. The increase of 47.03% was mainly due to increase in salary, wages & incentive expense.

Finance costs:

These costs were for the financial Year 2022-23 increased to Rs. 472.76 Lakhs as against Rs. 290.79 Lakhs during the financial year 2021-22. The increase of 62.58% was due to increase in the borrowings. The increase in borrowing cost was attributable due to increase in borrowings of the company to Rs. 4646.82 lakhs in fiscal 2023 from Rs. 2532.38 lakhs in fiscal 2022.

Depreciation and Amortization Expenses:

Depreciation for the financial year 2022-23 stood at Rs. 239.16 Lakhs as against Rs. 219.98 Lakhs during the financial year 2021-22. The increase in depreciation was around 8.72% in comparison to the previous year.

Other Expenses:

Our Company has incurred Rs. 2062.74 Lakhs during the Financial Year 2022-23 on other expenses as against Rs. 1612.13 Lakhs during the financial year 2021-22. There was an increase of 27.95% mainly due to increase in expenses like custom duty expenses, import expenses, power & fuel expenses, legal & professional fees, insurance expenses etc.

Restated profit before tax:

Net profit before tax for the financial year 2022-23 increased to Rs. 755.49 Lakhs as compared to Rs. 564.53 Lakhs in the financial year 2021-22, which was majorly due to factors as mentioned above.

Restated profit for the year:

The Company reported Restated profit after tax for the financial year 2022-23 of Rs. 560.27 Lakhs in comparison to Rs. 426.03 lakhs in the financial year 2021-22. The increase of 31.51% was majorly due to factors mentioned above.

In F.Y. 2022-23, PAT margin has increased only by 0.04% i.e. from 0.45% in FY 2021-22 to 0.49% in FY 2022-23. With increase in turnover, only variable expenses increase whereas fixed expenses remain the same. Hence, PAT amount increases in absolute terms, but margins are more or less same.

Information required as per Item (II)(C)(iv) of Part A of Schedule VI to the SEBI Regulations:

An analysis of reasons for the changes in significant items of income and expenditure is given hereunder:

1. Unusual or infrequent events or transactions

There has not been any unusual trend on account of our business activity. Except as disclosed in this Prospectus, there are no unusual or infrequent events or transactions in our Company.

2. Significant economic changes that materially affected or are likely to affect income from continuing operations.

There are no significant economic changes that may materially affect or likely to affect income from continuing operations.

3. Known trends or uncertainties that have had or are expected to have a material adverse impact on sales, revenue or income from continuing operations.

Apart from the risks as disclosed under Section “**Risk Factors**” beginning on page 25 of this Prospectus, in our opinion there are no other known trends or uncertainties that have had or are expected to have a material adverse impact on revenue or income from continuing operations.

4. Future changes in relationship between costs and revenues

Other than as described in the sections “**Risk Factors**”, “**Our Business**” and “**Management’s Discussion and Analysis of Financial Condition and Results of Operations**” on pages 25, 98 and 185 respectively, to our knowledge, no future relationship between expenditure and income is expected to have a material adverse impact on our operations and finances.

5. Segment Reporting

Our business activity primarily falls within a single business and geographical segment, other than as disclosed in “**Restated Financial Statements**” on page 144 we do not follow any other segment reporting

6. Status of any publicly announced New Products or Business Segment

Except as disclosed in the Chapter “**Our Business**”, our Company has not announced any new product or service.

7. Seasonality of business

Our business is not subject to seasonality. For further information, see “**Industry Overview**” and “**Our Business**” on pages 86 and 98, respectively.

8. Dependence on single or few customers

Given the nature of our business operations, we do not believe our business is dependent on any single or a few customers

9. Competitive conditions

Competitive conditions are as described under the Chapters “**Industry Overview**” and “**Our Business**” beginning on pages 86 and 98 respectively of this Prospectus.

10. Details of material developments after the date of last balance sheet i.e. March 31, 2024.

After the date of last Balance sheet i.e. March 31, 2024, the following material events have occurred after the last audited period –

- 1) A special resolution has been passed by the shareholders at the Extra Ordinary General Meeting held on February 10, 2024 for change of name of our Company from “Sunlite Recycling Industries Private Limited” to “Sunlite Recycling Industries Limited” and a fresh certificate of incorporation was issued by the Registrar of Companies, Central Processing Centre vide its letter dated April 30, 2024.
- 2) The Issue has been authorized by the Board of Directors vide a resolution passed at its meeting held on May 01, 2024 and approved by the shareholders of our Company vide a special resolution at the Extra Ordinary General Meeting held on May 06, 2024 pursuant to section 62(1)(c) of the Companies Act, 2013.
- 3) Our company has approved the restated audited financial statements for financial year ending March 31 2024, March 31, 2023 and March 31, 2022 in the Board meeting dated July 20, 2024.
- 4) Our Company has approved the Draft Red Herring Prospectus vide resolution in the Board Meeting dated May 21, 2024.
- 5) Our Company has approved the Red Herring Prospectus vide resolution in the Board Meeting dated August 05, 2024.
- 6) Our Company has approved the Prospectus vide resolution in the Board Meeting dated August 16, 2024.

CAPITALISATION STATEMENT**(Amount in Rs. Lakhs)**

Particulars	Pre Issue	Post Issue*
	March 31, 2024	
Debt		
Short Term Debt	2867.54	1467.54
Long Term Debt	624.20	[444.20
Total Debt	3491.74	1911.74
Shareholders' Fund (Equity)		
Share Capital	800.00	1088.00
Reserves & Surplus	1203.90	3939.90
Less: Miscellaneous Expenses not w/off	-	-
Total Shareholders' Fund (Equity)	2003.90	5027.90
Long Term Debt/Equity	0.31	0.09
Total Debt/Equity	1.74	0.38

* The corresponding post issue figures are based on Peer review Auditor's Certificate dated August 16, 2024

Notes:

1. Short term Debts represent which are expected to be paid/payable within 12 months and excludes installment of term loans repayable within 12 months.
2. Long term Debts represent debts other than Short term Debts as defined above but includes installment of term loans repayable within 12 months grouped under other current liabilities.
3. The figures disclosed above are based on restated statement of Assets and Liabilities of the Company as at March 31, 2024.
4. While calculating the post issue shareholder's funds, we have considered the impact of fresh issue of 28,80,000 equity shares being offered through IPO at a price of ₹105/- per share. We've not taken impact of estimated issue expenses.
5. While calculating post-issue borrowings, we have only given the impact of re-payment of debts of ₹1580.00 lakhs, which is to be utilized by the Company from the Issue proceeds.

SECTION VII – LEGAL AND OTHER INFORMATION**OUTSTANDING LITIGATION AND MATERIAL DEVELOPMENTS**

Except as stated in this section, there are no: (i) criminal proceedings; (ii) actions by statutory or regulatory authorities; (iii) outstanding claims relating to direct and indirect taxes; (iv) disciplinary actions including penalties imposed by SEBI or stock exchanges against the Promoters in the last five financial years, including outstanding action; or (v) Material Litigation (as defined below); involving our Company, Directors, Promoters and its Group Company.

Our Board, in its meeting held on May 08, 2024 determined that outstanding legal proceedings involving the Company, its Directors, Promoters and its Group Company will be considered as material litigation (“**Material Litigation**”) if the aggregate amount involved in such individual litigation exceeds 1% of profit after tax of the Company, as per the last restated financial statements of the Company or such litigations outcome could have a material impact on the business, operations, prospects or reputations of the Company.

The Company has a policy for identification of Material Outstanding dues to Creditors in terms of the SEBI (ICDR) Regulations, 2018 amended for creditors where outstanding due to any one of them exceeds 5.00% of the Company’s trade payables as per the last restated financial statements.

A. LITIGATION INVOLVING THE COMPANY**a) Criminal proceedings against the Company**

As on the date of this Prospectus, there are no outstanding criminal proceedings initiated against the Company.

b) Criminal proceedings filed by the Company

As on the date of this Prospectus, there are no outstanding criminal proceedings filed by the Company except as mentioned below:

- i. A case bearing no. CC/7119/2021 was filed by our Company through Nitin Kumar Heda against Harjot Traders (“Defendant”) before the Additional Chief Judicial Magistrate, Civil Court Nadiad (“Ld. Court”) under section 138 of Negotiable Instrument Act, 1881. The case relates to dishonor of cheque’s amounting of Rs. 2.96 Lakhs due to “insufficient funds”. The subject matter is pending adjudication before Ld. Court and the next date of hearing is June 07, 2024.
- ii. A case bearing no. CC/7120/2021 was filed by our Company Nitin Kumar Heda against Vanseka Enterprise Prop. Umesh Kumar Satish Lal (“Defendant”) before the Additional Chief Judicial Magistrate, Civil Court Nadiad (“Ld. Court”) under section 138 of Negotiable Instrument Act, 1881. The case relates to dishonor of cheque’s amounting of Rs. 2.30 Lakhs due to “insufficient funds”. The subject matter is pending adjudication before Ld. Court and the next date of hearing is June 07, 2024.

c) Actions by statutory and regulatory authorities against the Company

As on the date of this Prospectus, there are no outstanding actions by statutory or regulatory authorities initiated against the Company.

d) Tax Proceedings

Direct Tax: The details pertaining to **direct Tax** are as follows:

Nature of Cases	No. of Outstanding Cases	Amount in dispute/demanded to the extent ascertainable
Direct Tax (TDS Default)	1	1.62
Total	1	1.62

Indirect Tax: The details pertaining to **Indirect Tax** are as follows:

Sr. No.	Financial Year	Demand Raised under Section	Matter	Amount involved in Rs. Lakhs	Current Status
1.	2017-2021	Section 74 of Central Goods and Services Tax Act, 2017	As per notice dated July 30, 2024 issued due to differential tax liability and input tax credit wrongly availed or utilized, and hence there has been tax liability imposed.	70.52	The Company has not filed a reply to such show cause notice yet.
2.	2019-20	Section 73 (5) of Central Goods and Services Tax Act, 2017	As per notice dated May 24, 2024 issued due to differential tax liability and input tax credit wrongly availed or utilized, and hence there has been tax liability and penalty imposed.	96.45	The Company has not filed a reply to such show cause notice yet.
3.	2019-20	Section 74 (5) of Central Goods and Services Tax Act, 2017	As per notice dated May 24, 2024 issued due to input tax credit wrongly availed or utilized, there has been tax liability and penalty imposed.	473.51	The Company has filed the reply dated July 18, 2024 to such show cause notice mentioning the reasons while disagreeing with the contents of mentioned notice.
4.	2020-21	Section 61 & 73 of Central Goods and Services Tax Act, 2017	As per notice dated October 17, 2023, due to Difference of RCM Liability and difference of ITC claimed in GSTR 3B, and tax and interest liability was imposed.	922.55	The Company has filed the reply dated November 01, 2023 to such show cause notice disagreeing with such demands.
5.	2023-24	Section 129(3) of The Gujarat Goods and Services Tax Act, 2017 read with Section 68(3) of Central Goods and Services Tax Act, 2017.	As per order passed by Deputy Commissioner of State Tax dated September 17, 2023 regarding an inspection of goods in movement of the Company, discrepancy has been found in relation to wrong vehicle number. A penalty amounting Rs.21, 00,884 was imposed.	-	The Company has paid the penalty of Rs.21, 00,884/- under protest and the Company has also filed an appeal against the mentioned order before the Deputy Commissioner of State Tax – Appeal Division, stating that due to urgent change in vehicle, there was discrepancy in the vehicle number and Company has made an outwards supply to its customer with all the rest of the details being correct.
TOTAL					1563.03

e) Other pending material litigations against the Company

As on date of Prospectus, there are no outstanding litigations initiated against the Company, which have been considered material by the Company in accordance with the Materiality Policy.

f) Other pending material litigations filed by the Company

As on the date of this Prospectus, there are no other pending material litigations against the Company.

B. LITIGATIONS INVOLVING THE PROMOTERS & DIRECTORS OF THE COMPANY

a) Criminal proceedings against the Promoters & Directors of the Company

As on the date of this Prospectus, there are no outstanding criminal proceedings against the Promoters & Directors of the company.

b) Criminal proceedings filed by the Promoters & Directors of the Company

As on the date of this Prospectus, there are no outstanding criminal proceedings filed by the Directors of the Company.

c) Actions by statutory and regulatory authorities against the Promoters & Directors of the Company

As on the date of this Prospectus, there are no outstanding actions by statutory or regulatory authorities initiated against the Directors.

d) Tax Proceedings

Tax Proceedings	Number of cases	Amount involved (₹ in lakhs)
Promoters and Directors:		
Direct Tax	Nil	Nil
Indirect Tax	Nil	Nil
Total	Nil	Nil

e) Other pending material litigations against the Promoters & Directors of the Company

As on the date of this Prospectus, there are no such outstanding litigations against the Directors, which have been considered material by the Company in accordance with the Materiality Policy.

f) Other pending material litigations filed by the Promoters & Directors of the Company

As on the date of this Prospectus, there are no such outstanding litigations initiated filed by the Directors, which have been considered material by the Company in accordance with the Materiality Policy.

C. LITIGATIONS INVOLVING THE GROUP COMPANY

a) Criminal proceedings against the Group Company

As on the date of this Prospectus, there are no criminal proceedings against Group Company.

b) Criminal proceedings filed by the Group Company

As on the date of this Prospectus, there are no criminal proceedings filed by our Group Company.

c) Actions by statutory and regulatory authorities against the Group Company

As on the date of this Prospectus, there are no outstanding actions by statutory or regulatory authorities initiated against our Group Company.

d) Tax Proceedings

Tax Proceedings	Number of cases	Amount involved (₹ in lakhs)
Direct Tax	Nil	Nil
Indirect Tax	Nil	Nil
Total	Nil	Nil

e) Other pending material litigations against the Group Company

As on the date of this Prospectus, there are no outstanding material litigation against Group Company.

f) Other pending material litigations filed by the Group Company

As on the date of this Prospectus, there are no outstanding material litigation filed by Group Company.

D. AMOUNTS OWED TO SMALL SCALE UNDERTAKINGS AND OTHER CREDITORS:

The Board of Directors of our Company considers dues exceeding 5% of our Company's trade payables as per the last Restated financial statements, to small scale undertakings and other creditors, as material dues for our Company.

As per Restated Financial Statements, the trade payables of our Company as on March 31, 2024 were Rs. 50.55 Lakhs. Accordingly, a creditor has been considered 'material' if the amount due to such creditor exceeds Rs. 2.53 Lakhs as on March 31, 2024. This materiality threshold has been approved by our Board of Directors pursuant to the resolution passed on May 08, 2024. As on March 31, 2024, there are 04 creditors to each of whom our Company owes amounts exceeding 5.00% of our Company's total trade payables and the aggregate outstanding dues to them being approximately Rs. 45.18 Lakhs.

As per the above materiality policy, the outstanding amount owned to small scale undertakings and material creditors as on March 31, 2024, by our Company is as follows:

Type of Creditors	Number of Creditors	Total Amount Outstanding	No of Material Creditors	Amount of Material Creditors	<i>Amt. in Rs. Lakhs</i>	
					No of Other Creditors	Amount of Other Creditors
Micro, small and medium enterprises	03	0.80	-	-	03	0.80
Other Creditors	15	49.75	04	45.18	11	4.57
Total	18	50.55	04	45.18	14	5.37

The details pertaining to amounts due towards material creditors are available on the website of our Company

MATERIAL DEVELOPMENTS OCCURRING AFTER LAST BALANCE SHEET DATE:

Except as disclosed in Chapter titled "*Management's Discussion & Analysis of Financial Conditions & Results of Operations*" beginning on page 185 of this Prospectus, there have been no material developments that have occurred after the Last Balance Sheet date.

GOVERNMENT AND OTHER APPROVALS

Our Company has received the necessary licenses, permissions and approvals from the Central and State Governments and other government agencies/regulatory authority's/certification bodies required to undertake the issue or continue our business activities and except as mentioned below, no further approvals are required for carrying on our present or proposed business activities.

In view of the approvals listed below, we can undertake this issue and our current business activities and no further major approvals from any governmental or regulatory authority or any other entity are required to be undertaken in respect of the issue or to continue our business activities. It must be distinctly understood that, in granting these approvals, the Government of India does not take any responsibility for our financial soundness or for the correctness of any of the statements made or opinions expressed in this behalf. Unless otherwise stated, these approvals are all valid as of the date of this Prospectus. The main objects clause of the Memorandum of Association of our Company and the objects incidental, enable our Company to carry out its activities.

The Company has got following licenses / registrations / approvals / consents / permissions from the Government and various other Government agencies required for its present business.

For further details in connection with the regulatory and legal framework within which we operate, please refer to the chapter titled 'Key Industry Regulations and Policies' on page 110 of this Prospectus.

I. Approvals for the Issue:

The following approvals have been obtained or will be obtained in connection with the Issue

Corporate Approvals:

- a. The Board of Directors has, pursuant to a resolution dated May 01, 2024 under Section 62(1)(c) of the Companies Act, 2013 passed at its meeting held on authorized the Issue, subject to the approval of the shareholders of the Company and approvals by such other authorities, as may be necessary.
- b. The shareholders of the Company have, pursuant to a resolution passed in Extra Ordinary General Meeting held on May 06, 2024 authorized the Issue under Section 62(1)(c) of the Companies Act, 2013.
- c. Our Board approved the Draft Red Herring Prospectus pursuant to its resolution dated May 21, 2024.
- d. Our Board approved the Red Herring Prospectus pursuant to its resolution dated August 05, 2024.
- e. Our Board approved the Prospectus pursuant to its resolution dated August 16, 2024.

Approval from the Stock Exchange:

- f. In-principle approval dated July 29, 2024 from the NSE Emerge or using the name of the Exchange in the issue documents for listing of the equity shares issued by our Company pursuant to the issue.

Agreements with NSDL and CDSL:

- g. The company has entered into a Tripartite agreement dated March 07, 2024 with the Central Depository Services (India) Limited ("CDSL") and the Registrar and Transfer Agent, who in this case is Cameo Corporate Services Limited for the dematerialization of its shares.
- h. Similarly, the Company has also entered into a Tripartite agreement dated March 11, 2024 with the National Securities Depository Limited ("NSDL") and the Registrar and Transfer Agent, who in this case is Cameo Corporate Services Limited for the dematerialization of its shares.
- i. The Company's International Securities Identification Number ("ISIN") is INE0U2N01013.

II. Incorporation related Approvals:

Sr. No.	Nature of Registration/ License	CIN	Applicable Laws	Issuing Authority	Date of issue	Date of Expiry
1.	Certificate of Incorporation	U27200GJ2022PTC134540	Companies Act, 2013	Registrar of Companies, Central Registration Centre	August 04, 2022	Valid until Cancelled
2.	Fresh Certificate of Incorporation consequent upon change of name from “Sunlite Alucop Private Limited” to “Sunlite Recycling Industries Private Limited”	U27200GJ2022PTC134540	Companies Act, 2013	Registrar of Companies, Ahmedabad	January 18, 2024	Valid until Cancelled
3.	Fresh Certificate of Incorporation Consequent upon Conversion from Private Company to Public Company	U27200GJ2022PLC134540	Companies Act, 2013	Registrar of Companies, Central Processing Centre	April 30, 2024	Valid until Cancelled

III. Tax Related Approvals:

Sr. No.	Nature of Registration/ License	Registration/ License No.	Applicable Laws	Issuing Authority	Date of Issue/Renewal	Date of Expiry
1.	Permanent Account Number	ABJCS1297A	Income Tax Act, 1961	Commissioner of Income Tax	August 04, 2022	Valid until Cancelled
2.	Tax Deduction and Collection Account Number (TAN)	BRDS16657E	Income Tax Act, 1961	Income Tax Department	August 04, 2022	Valid until Cancelled
3.	GST Registration Certificate	24ABJCS1297A1ZI	Central Goods and Services Tax Act, 2017	Government of India	August 24, 2024 Last updated: May 03, 2024	Valid until Cancelled
4.	Professional Tax Registration (For Company)	01122700/1609/16	The Gujarat Panchayats, Municipalities, Municipal Corporations and State Tax on Professions, Trades, Callings and Employments Act, 1976	Municipal corporation in Gujarat	-*	Valid until Cancelled
5.	Professional Tax Registration (For Employee)	01122700/1609/20	The Gujarat Panchayats, Municipalities, Municipal Corporations and State Tax on Professions, Trades, Callings and Employments Act, 1976	Municipal corporation in Gujarat	-*	Valid until Cancelled

* Company is unable to trace the original physical certificate in relation to Professional Tax and has applied for copy of certificate vide application dated July 24, 2024.

IV. Corporate/General Authorizations:

Sr. No.	Nature of Registration/ License	Registration/ License No.	Applicable Laws	Issuing Authority	Date of Issue/ Renewal	Date of Expiry
1.	Certificate of Importer Exporter Code (IEC)	ABJCS1297A	Foreign Trade (Development and Regulation) Act, 1992	Ministry of Commerce & Industry, Office of the Additional Director General of Foreign Trade	August 18, 2022	Valid until Cancelled
2.	LEI Certificate	984500RD8F90AQ4 E8S27	-	LEI Register India Private Limited	September 09, 2022	September 16, 2024

V. Approvals obtained in relation to business operations of our Company:

Sr. No.	Nature of Registration/ License	Registration/ License No.	Applicable Laws	Issuing Authority	Date of Issue/ Renewal	Date of Expiry
1.	Factory Licence	Registration No.: 3853/24201/2013 Licence No.: 42036	Factories Act, 1948	Deputy Director Industrial Safety and Health, Nadiad	October 19, 2022	December 31, 2027
2.	Certificate of Verification	2754581/KHE/2023/01	Legal Metrology Act, 2009	Legal Metrology Officer	September 27, 2023	September 27, 2024
3.	Certificate of Verification	2752780/KHE/2023/01	Legal Metrology Act, 2009	Legal Metrology Officer	September 30, 2023	September 30, 2024
4.	Certificate of Verification	2866477/KHE/2023/01	Legal Metrology Act, 2009	Legal Metrology Officer	December 19, 2023	December 19, 2025
5.	No Objection Certificate (NOC) for Ground Water Abstraction	CGWA/NOC/IND/ORIG/2023/18708	Environment (Protection) Act, 1986	River Development and Ganga Rejuvenation, Central Ground Water Authority, Department of Water Resources	June 15, 2023	April 14, 2026
6.	Registration Certificate under Shops & Establishments Act (Marketing Office)	Registration No.: 2410200319033560	Maharashtra shop and Establishments (Regulations of Employment and conditions of Service) Act, 2017	Deputy Commissioner of Labour, Thane	July 17, 2024	Valid till Cancelled

VI. Environmental Law Related Approvals:

Sr. No.	Nature of Registration/ License	Registration/ License No.	Applicable Laws	Issuing Authority	Date of Issue/ Renewal	Date of Expiry
---------	---------------------------------	---------------------------	-----------------	-------------------	------------------------	----------------

1.	Consolidated Consent and Authorization (CC & A)	AWH-127921	U/s 25 of the Water (Prevention and Control of Pollution) Act, 1974 & U/s 21 of the Air (Prevention and Control of Pollution) Act, 1981, Authorisation under rule 6(2) of the Hazardous and Other Waste (Management And Transboundary Movement) Rules, 2016 framed under Environment (Protection) Act, 1986	Gujarat Pollution Control Board, Nadiad	July 25, 2023	June 20, 2028
----	---	------------	---	---	---------------	---------------



VII. Labour Related Approvals obtained by our Company:

Sr. No.	Nature of Registration/ License	Registration/ License No.	Applicable Laws	Issuing Authority	Date of Issue/ Renewal	Date of Expiry
1.	Registration under Employees' Provident Funds And Miscellaneous Provisions Act, 1952	GJAHD2634007000	Employees' Provident Funds & Miscellaneous Provisions Act, 1952	Employee Provident Fund Organisation	December 22, 2023	Valid until Cancelled

VIII. Quality Certifications:

S. No.	Nature of Registration/ License	Registration/ Certificate No.	Description	Issuing Authority	Date of Issue	Date of Expiry
1.	Certificate of Registration (Manufacture of Copper Rods, Copper Strips, Copper Flats, Copper Wires, Copper Wire Bunch, Copper Cable and Copper Ingots)	ICI/2530489/22	ISO 9001:2015 (Quality Management System)	Director, International Certification & Inspection UK Limited	October 19, 2022	October 18, 2025

IX. Intellectual property related approvals:

S. No.	Brand name/ Logo Trademark/Copyright	Class	TM Category	Applicant	Trademark Number/ Application No./ Registration Certificate Number	Issuing Authority	Date of Application	Status
1.		6	Device	Sunlite Recycling Industries Limited	TM Application No: 6434402	Registrar of Trademark	May 15, 2024	Formalities Chk Pass
2.		6	Device	Sunlite Industries	Application No. 3796778 Certificate No. 1996711	Registrar of Trademark	April 04, 2018	Registered

X. Licenses/ Approvals which are applied by Company and are pending for approval:

1. The Company is yet to apply for change of its name in all permits, licenses and approvals, which has been obtained under the Company's former name.
2. We have made application dated May 15, 2024 for  as trademark in class 6 Application number for the same is 6434402 Current status for this application is "Not registered (*Formalities Chk Pass*)".

XI. Licenses/ Approvals are yet to be applied by Company: Nil

OUR GROUP COMPANY

In accordance with the provisions of the SEBI (ICDR) Regulations, 2018, for the purpose of identification of Group Company, our Company has considered those companies as our Group Company with which there were related party transactions as per the Restated Financial Statements of our Company in any of the last three financial years and stub period (if any) and other Company as considered material by our Board. Further, pursuant to a resolution of our Board dated May 08, 2024, for the purpose of disclosure in relation to Group Company in connection with the Issue, a company shall be considered material and disclosed as a Group company if such company fulfills both the below mentioned conditions: -

- a. the companies with which there were related party transactions (in accordance with AS-18), as disclosed in the Restated Financial Statements (“**Restated Financial Statements**”); or
- b. if such company fulfills both the below mentioned conditions: -
 - i. Such company that forms part of the Promoter Group of the Company in terms of Regulation 2(1)(pp) of the SEBI (ICDR) Regulations; and
 - ii. The Company has entered into one or more transactions with such company in preceding fiscal or audit period as the case may be exceeding 10.00% of total revenue of the Company as per Restated Financial Statements.

Except as stated, there are no company/entity falling under definition of SEBI (Issue of Capital and Disclosure Requirements) Regulations, 2018 which are to be identified as group company/ entity (“**Group Company**”).

1. Sunlite Aluminium Private Limited

Details of our Group Company:

1. Sunlite Aluminium Private Limited

Sunlite Aluminium Private Limited was incorporated on August 25, 2022 as a private limited company under the Companies Act, 2013 pursuant to a certificate of incorporation issued by the Registrar of Companies, Ahmedabad.

CIN	U27109GJ2022PTC134960
PAN	ABJCS2552C
Registered Office	Survey No.271 and 272-1, Chhatha Mile, Dantali, Vaso, Kheda -387350, Gujarat, India.

Financial Information

In accordance with the SEBI ICDR Regulations, details of reserves (excluding revaluation reserves), sales, profit after tax, earnings per share, basis/diluted earnings per share and Net Asset Value, derived from the latest audited financial statements of our Group Company is available on the website of our company at www.sunliteindustries.com.

It is clarified that such details available on our Group Company’ websites do not form a part of this Prospectus. Anyone placing reliance on any other source of information, including our Group Company’ website, as mentioned above, would be doing so at their own risk.

Other Confirmations:

- a) None of our Group Company has made any public and/or rights issue of securities in the preceding three years.
- b) None of the above-mentioned Group Company is in defaults in meeting any Statutory/bank/institutional dues and no proceedings have been initiated for economic offences against any of the Group Company.
- c) None of the above-mentioned Group Company is a sick company within the meaning of the Sick Industrial Companies (Special Provisions) Act, 1985 or is under winding up/insolvency proceedings.
- d) Our Group Company has not been debarred from accessing the capital market for any reasons by the SEBI or any other authorities.

Common pursuits among Group Company:

As on the date of this Prospectus, our Group Company, namely Sunlite Aluminium Private Limited are engaged in metals recycling Industry, which is similar line of business as of our Company. As a result, conflicts of interests may arise in allocating business opportunities amongst our Companies and in circumstances where our respective interests diverge.

Nature and extent of interest of our Group Company

a) Interest in the promotion of our Company

None of our Group Company has any interest in the promotion of our Company.

b) Interest in the property acquired or proposed to be acquired by the Company

None of our Group Company is interested, directly or indirectly, in the properties acquired by our Company in the preceding three years or proposed to be acquired by our Company.

c) Interest in transactions for acquisition of land, construction of building, or supply of machinery

None of our Group Company is interested, directly or indirectly, in any transactions for acquisition of land, construction of building, supply of machinery, with our Company.

Related business transactions and their significance on the financial performance of our Company

Other than the transactions disclosed in the section “*Other Financial Information –Related Party Transactions*” on page 176, there are no related business transactions between the Group Company and our Company.

Business interest of our Group Company in our Company

Except as disclosed in the section “*Other Financial Information –Related Party Transactions*” on page 176, our Group Company has no business interests in our Company.

Litigations

Except as disclosed in the section “*Outstanding litigations and material developments*” on page 195 of this Prospectus. Our Group Company is not party to any litigation which may have material impact on our Company.

Undertaking / Confirmations by our Group Company

None of our Promoters or Promoter Group or Group Company or person in control of our Company has been

- i. Prohibited from accessing or operating in the capital market or restrained from buying, selling or dealing in securities under any order or direction passed by SEBI or any other authority; or
- ii. Refused listing of any of the securities issued by such entity by any stock exchange, in India or abroad.

None of our Promoters, person in control of our Company or have ever been a Promoter, Director or person in control of any other Company which is debarred from accessing the capital markets under any order or direction passed by the SEBI or any other authority.

Further, neither our Promoters, the relatives of our individual Promoters (as defined under the Companies Act) nor our Group Company /Promoter Group entities have been declared as a willful defaulter or economic offender by the RBI or any other government authority and there are no violations of securities laws committed by them or any entity they are connected with in the past and no proceedings for violation of securities laws are pending against them. The information as required by the SEBI (ICDR) Regulations with regards to the Group Company, are also available on the website of our company i.e. www.sunliteindustries.com.

OTHER REGULATORY AND STATUTORY DISCLOSURES

Authority for the Issue

Corporate Approvals

The Board of Directors has, pursuant to a resolution passed at its meeting held on May 01, 2024 authorized the Issue, subject to the approval of the shareholders of the Company under Section 62(1)(c) and all other applicable provisions of the Companies Act, 2013.

The shareholders of the Company have, pursuant to a special resolution passed in Extra Ordinary General Meeting held on May 06, 2024 authorized the Issue under Section 62(1)(c) and all other applicable provisions of the Companies Act, 2013.

In-principal Approval

Our Company has received an In-Principle Approval letter dated July 29, 2024 from NSE for using its name in this Prospectus for listing our shares on the SME Platform of NSE. NSE is the Designated Stock Exchange for the purpose of this Issue.

Prohibition by SEBI, RBI or governmental authorities

We confirm that our Company, Promoters, Promoter Group and Directors have not been declared as wilful defaulter(s) or fraudulent borrowers by the RBI or any other governmental authority. Further, there has been no violation of any securities law committed by any of them in the past and no such proceedings are currently pending against any of them.

We confirm that our Company, Promoters, Promoter Group or Directors have not been prohibited from accessing or operating in the capital markets under any order or direction passed by SEBI or any other regulatory or Governmental Authority.

- Neither our Company, nor Promoters, nor Promoter Group, nor any of our Directors or persons in control of our Company are /were associated as promoter, directors or persons in control of any other Company which is debarred from accessing or operating in the capital markets under any order or directions made by the SEBI or any other regulatory or Governmental Authorities.
- None of our Directors are associated with the securities market and there has been no action taken by the SEBI against the Directors or any other entity with which our Directors are associated as Promoter or Director.
- Neither our Promoters, nor Promoter Group, nor any of our Directors is declared as Fugitive Economic Offender.
- Neither our Company, nor our Promoters, nor Promoter Group nor our Directors, are Wilful Defaulters or fraudulent borrowers.

Prohibition by RBI

Neither our Company, nor Promoters, nor Promoter Group, nor any of our Directors or the person(s) in control of our Company have been identified as a wilful defaulter or fraudulent borrowers by the RBI or other governmental authority and there has been no violation of any securities law committed by any of them in the past and no such proceedings are pending against any of them except as details provided under chapter titled “*Outstanding Litigations and Material Developments*” beginning on page 195 of this Prospectus.

Neither our Company, our Promoters, our Directors, Group companies, relatives (as per Companies Act, 2013) of Promoters or the person(s) in control of our Company have been identified as wilful defaulters or a fraudulent borrower as defined by the SEBI ICDR Regulations, 2018.

Directors associated with the securities market:

Our Company, our Promoters, our Directors and our Promoter’s Group, person(s) in control of the promoters or issuer, have not been prohibited from accessing the capital market or debarred from buying, selling, or dealing in securities under any order or direction passed by the Board or any securities market regulators in any other jurisdiction or any other authority/court.

Prohibition with respect to wilful defaulter or a fraudulent borrower

Neither our Company, our Promoter, our Directors, Group Companies, relatives (as per Companies Act, 2013) of Promoter or the person(s) in control of our Company have been identified as wilful defaulter or a fraudulent borrower as defined by the SEBI (ICDR) Regulations, 2018.

Compliance with the Companies (Significant Beneficial Ownership) Rules, 2018

Our Company, Promoter and Promoter Group are in compliance with the Companies (Significant Beneficial Ownership) Rules, 2018 to the extent applicable to each of them as on the date of the Prospectus.

Confirmations

- i. Neither our company, nor any of its promoters, promoter group or directors are debarred from accessing the capital market by the Board.
- ii. Neither our promoters, nor any directors of our company are a promoter or director of any other company which is debarred from accessing the capital market by the Board
- iii. Neither our Company, nor our Promoters or our directors, is a Willful Defaulter or a fraudulent borrower.
- iv. Neither our Promoters nor any of our directors is declared as Fugitive Economic Offender.

Eligibility for the Issue

Our Company is eligible in terms of Regulations 230 of SEBI (ICDR) Regulations for this issue.

Our Company is an “Unlisted Issuer” in terms of the SEBI (ICDR) Regulations; and this issue is an Initial Public Issue in terms of the SEBI (ICDR) Regulations.

Our Company is eligible for the Issue in accordance with Regulation 229(2) and other provisions of Chapter IX of the SEBI (ICDR) Regulations, as we are an Issuer whose post issue paid up capital is more than ten crore rupees and we may hence issue Equity Shares to the public and propose to list the same on the Small and Medium Enterprise Exchange {in this case being the “SME Platform of NSE (“NSE Emerge”)} }

We confirm that:

1. In accordance with Regulation 260 of the SEBI (ICDR) Regulations, this issue will be 100% underwritten and that the Book Running Lead Manager to the Issue shall underwrite minimum 15% of the Total Issue Size. For further details pertaining to said underwriting please refer to section titled “**General Information – Underwriting**” beginning on page 54 of this Prospectus.
2. In accordance with Regulation 268 of the SEBI (ICDR) Regulations, we shall ensure that the total number of proposed allottees in the Issue shall be greater than or Equal to fifty (50), otherwise, the entire application money will be unblocked forthwith. If such money is not repaid within eight (8) Working Days from the date our Company becomes liable to repay it, then our Company and every officer in default shall, on and from expiry of eight (8) Working Days, be liable to repay such application money, with an interest at the rate as prescribed under the Companies Act, 2013.
3. In terms of Regulation 246(5) of the SEBI (ICDR) Regulations, we shall ensure that our Book Running Lead Manager submits a copy of the Prospectus along with a Due Diligence Certificate including additional confirmations as required to SEBI at the time of filing the Prospectus with Stock Exchange and the Registrar of Companies. Further, in terms of Regulation 246(2), SEBI shall not issue observation on the Draft Red Herring Prospectus/ Red Herring Prospectus/ Prospectus.
4. In accordance with Regulation 261(1) of the SEBI (ICDR) Regulations, we hereby confirm that we will enter into an agreement with the Book Running Lead Manager and with Market Maker to ensure compulsory Market Making for a minimum period of three (3) years from the date of listing of Equity Shares on the SME Platform of NSE (“NSE Emerge”). For further details of the arrangement of market making please refer to section titled “**General Information- Details of the Market Making Arrangements for this Issue**” beginning on page 55 of this Prospectus.

5. In accordance with Regulation 228(c) of the SEBI (ICDR) Regulations, Neither the issuer nor any of its promoter or directors is a wilful defaulter or a fraudulent borrower.
6. In accordance with Regulation 228(d) of the SEBI (ICDR) Regulations, None of the Issuer's promoter or directors is a fugitive economic offender.
7. In accordance with Regulation 230(1)(a) of the SEBI (ICDR) Regulations, Application is being made to SME Platform of NSE ("NSE Emerge") is the Designated Stock Exchange.
8. In accordance with Regulation 230(1)(b) of the SEBI (ICDR) Regulations, our Company has entered into agreement with depositories for dematerialisation of specified securities already issued and proposed to be issued.
9. In accordance with Regulation 230(1)(c) of the SEBI (ICDR) Regulations, all the present Equity share Capital is fully Paid-up.
10. In accordance with Regulation 230(1)(d) of the SEBI (ICDR) Regulations, all the specified securities held by the promoter is already in dematerialised form.

We further confirm that we shall be complying with all the other requirements as laid down for such an Offer under Chapter IX of SEBI (ICDR) Regulations, 2018 as amended from time to time and subsequent circulars and guidelines issued by SEBI and the Stock Exchange.

1. Our Company has facilitated trading in demat securities and has entered into an agreement with both the depositories. Our Company has entered into an agreement with Central Depository Services Limited (CDSL) dated March 07, 2024 and National Securities Depository Limited (NSDL) dated March 11, 2024 for dematerialization of its Equity Shares already issued and proposed to be issued.
2. Our Company has a website i.e. www.sunliteindustries.com
3. The Equity Shares of our Company held by our Promoters are in dematerialised form; and
4. All the Equity Shares are fully paid-up and there are no partly paid-up Equity Shares as on the date of filing of this Prospectus.
5. There has been no change in the promoter(s) having significant change in control over the affairs of the Company in the one year preceding the date of filing application to SME Platform of NSE.

Our Company also complies with the eligibility conditions laid by the SME Platform of National Stock Exchange of India Limited for listing of our Equity Shares. The point wise Criteria for SME Platform of National Stock Exchange of India Limited and compliance thereof are given hereunder;

- 1) Our company was originally formed as partnership firm under the Indian Partnership Act, 1932 ("Partnership Act") in the name and style of "M/s. Sunlite Industries, pursuant to a deed of partnership entered between Prahladrai Ramdayal Heda, Nitin Kumar Heda and Khushboo Manishkumar Heda executed on dated September 28, 2017 on the terms and conditions contained in the said partnership deed. Later on, "M/s Sunlite Industries" was thereafter converted from partnership firm to a private limited Company under part I Chapter XXI of Section 366 of the Companies Act, 2013 with the name and style of "Sunlite Alucop Private Limited" and received a certificate of incorporation dated August 04, 2022 issued by the Registrar of Companies, Central Registration Centre bearing Corporate Identification Number U27200GJ2022PTC134540. Further, pursuant to Special Resolution passed by the shareholders at the Extra Ordinary General Meeting held on January 12, 2024, the name of our Company was changed from "Sunlite Alucop Private Limited" to "Sunlite Recycling Industries Private Limited" and a fresh certificate of incorporation consequent upon change of name was issued by the Registrar of Companies, Ahmedabad vide letter dated January 18, 2024. Subsequently, our Company was converted into a Public Limited Company vide Special Resolution passed by the Shareholders at the Extra Ordinary General Meeting, held on February 10, 2024 and consequently the name of our Company was changed from "Sunlite Recycling Industries Private Limited" to "Sunlite Recycling Industries Limited" vide a fresh certificate of incorporation consequent upon conversion from private company to public company dated April 30, 2024 issued by the Registrar of Companies, Central Processing Centre. Our Company's Corporate Identity Number is U27200GJ2022PLC134540.
- 2) As on the date of this Prospectus, the Company has a Paid-up Capital of ₹800.00 Lakhs comprising 80,00,000 Equity shares and the Post Issue Paid up Capital (face value) of the company will be ₹ 1088.00 Lakh comprising 1,08,80,000 Equity Shares, which is less than ₹25 Crores.

- 3) Our Company has track record of more than three years as on date of filing of this Prospectus.
- 4) The Company confirms that it has operating profit (earnings before interest, depreciation and tax) from operations for atleast any 2 out of 3 financial years preceding the application and its net-worth for financial years ended March 31, 2024, March 31, 2023 and March 31, 2022 is positive.

(In Rs. Lakhs)

Particulars	March 31, 2024	March 31, 2023	March 31, 2022
EBITDA	1,836.07	1,422.88	990.75
Net worth	2,003.90	362.08	1,158.58

- 5) Our Company confirms that there is no material regulatory or disciplinary action by a stock exchange or regulatory authority in the past one year in respect of promoter, Group Companies, companies promoted by the promoter of the Company;
- 6) The Company has not been referred to the Board for Industrial and Financial Reconstruction (BIFR) or no proceedings have been admitted under Insolvency and Bankruptcy Code against the issuer and Promoting companies.
- 7) Our Company has not been referred to the National Company Law Tribunal (NCLT) under Insolvency and Bankruptcy Code, 2016.
- 8) None of the Directors of our Company have been categorized as a Wilful Defaulter or fraudulent borrowers.
- 9) There is no winding up petition against the company, which has been admitted by a Court of competent jurisdiction or a liquidator has not been appointed.
- 10) No material regulatory or disciplinary action by a stock exchange or regulatory authority in the past three years against the company
- 11) The directors of the issuer are not associated with the securities market in any manner, and there is no outstanding action against them initiated by the Board in the past five years
- 12) We confirm that:
- There is no material regulatory or disciplinary action taken by a stock exchange or regulatory authority in the past one year in respect of promoters/promoting company(ies), group companies, companies promoted by the promoters/promoting company(ies) of the applicant company.
 - There is no default in respect of payment of interest and/or principal to the debenture/bond/fixed deposit holders, banks, FIs by the applicant, promoters/promoting company(ies), group companies, companies promoted by the promoters/promoting company(ies) during the past three years.
 - There are no litigations record against the applicant, promoters/promoting company(ies), group companies, companies & promoted by the promoters/promoting company(ies) except as stated in the section titled “**Outstanding Litigation and Material Developments**” beginning on page 195 of this Prospectus.
 - There are no criminal cases/investigation/offences filed against the director of the company except as stated in the section titled “**Outstanding Litigation and Material Developments**” beginning on page 195 of this Prospectus.

We further confirm that we comply with all the above requirements / conditions so as to be eligible to be listed on the SME Platform of NSE.

DISCLAIMER CLAUSE OF SEBI

IT IS TO BE DISTINCTLY UNDERSTOOD THAT SUBMISSION OF OFFER DOCUMENT TO THE SECURITIES AND EXCHANGE BOARD OF INDIA (SEBI) SHOULD NOT IN ANY WAY BE DEEMED OR CONSTRUED THAT THE SAME HAS BEEN CLEARED OR APPROVED BY SEBI. SEBI DOES NOT TAKE ANY RESPONSIBILITY EITHER FOR THE FINANCIAL SOUNDNESS OF ANY SCHEME OR THE PROJECT FOR WHICH THE OFFER IS

PROPOSED TO BE MADE OR FOR THE CORRECTNESS OF THE STATEMENTS MADE OR OPINIONS EXPRESSED IN THE OFFER DOCUMENT. THE BOOK RUNNING LEAD MANAGER, HEM SECURITIES LIMITED HAS CERTIFIED THAT THE DISCLOSURES MADE IN THE OFFER DOCUMENT ARE GENERALLY ADEQUATE AND ARE IN CONFORMITY WITH THE SEBI (ISSUE OF CAPITAL AND DISCLOSURE REQUIREMENTS) REGULATIONS, 2018 IN FORCE FOR THE TIME BEING. THIS REQUIREMENT IS TO FACILITATE INVESTORS TO TAKE AN INFORMED DECISION FOR MAKING INVESTMENT IN THE PROPOSED ISSUE.

IT SHOULD ALSO BE CLEARLY UNDERSTOOD THAT WHILE THE ISSUER IS PRIMARILY RESPONSIBLE FOR THE CORRECTNESS, ADEQUACY AND DISCLOSURE OF ALL RELEVANT INFORMATION IN THE OFFER DOCUMENT, THE BOOK RUNNING LEAD MANAGER, HEM SECURITIES LIMITED IS EXPECTED TO EXERCISE DUE DILIGENCE TO ENSURE THAT THE ISSUER DISCHARGES ITS RESPONSIBILITY ADEQUATELY IN THIS BEHALF AND TOWARDS THIS PURPOSE, THE BOOK RUNNING LEAD MANAGER, HEM SECURITIES LIMITED, HAS FURNISHED TO SEBI A DUE DILIGENCE CERTIFICATE DATED MAY 21, 2024. IN THE FORMAT PRESCRIBED UNDER SCHEDULE V(A) OF THE SEBI (ISSUE OF CAPITAL AND DISCLOSURE REQUIREMENTS) REGULATIONS, 2018.

THE FILING OF THIS PROSPECTUS DOES NOT, HOWEVER, ABSOLVE OUR COMPANY FROM ANY LIABILITIES UNDER THE COMPANIES ACT, 2013 OR FROM THE REQUIREMENT OF OBTAINING SUCH STATUTORY AND/ OR OTHER CLEARANCES AS MAY BE REQUIRED FOR THE PURPOSE OF THE PROPOSED ISSUE. SEBI FURTHER RESERVES THE RIGHT TO TAKE UP AT ANY POINT OF TIME, WITH THE BOOK RUNNING LEAD MANAGER ANY IRREGULARITIES OR LAPSES IN THE OFFER DOCUMENT.

All legal requirements pertaining to the Issue will be complied with at the time of filing of the Prospectus with the Registrar of Companies, Ahmedabad in terms of sections 26, 30, 32 and 33 of the Companies Act, 2013.

Statement on Price Information of Past Issues handled by Hem Securities Limited (SME IPO's):

Sr. No.	Issue name	Issue size (₹ in Cr.)	Issue Price (₹)	Listing date	Opening Price on listing date	+/- % change in price, [+/- % change in closing benchmark]- 30 th calendar days from listing	+/- % change in closing price, [+/- % change in closing benchmark]- 90 th calendar days from listing	+/- % change in closing price, [+/- % change in closing benchmark]- 180 th calendar days from listing
1.	Amkay Products Limited	12.60	55.00	May 08, 2024	104.50	15.91% [4.39%]	34.73% [6.98%]	N.A.
2.	TGIF Agribusiness Limited	6.39	93.00	May 15, 2024	150.00	1.61% [5.49%]	-0.05% [8.18%]	N.A.
3.	Energy-Mission Machineries (India) Limited	41.15	138.00	May 16, 2024	366.00	218.62% [5.15%]	147.17% [7.77%]	N.A.
4.	Aztec Fluids & Machinery Limited	24.12	67.00	May 17, 2024	90.00	10.18% [4.58%]	N.A.	N.A.
5.	Premier Roadlines Limited	40.36	67.00	May 17, 2024	87.00	104.18% [4.86%]	N.A.	N.A.
6.	Vilas Transcore Limited	95.26	147.00	June 03, 2024	215.00	252.79% [4.40%]	N.A.	N.A.
7.	Aimtron Electronics Limited	87.02	161.00	June 06, 2024	241.00	310.93% [6.17%]	N.A.	N.A.
8.	Ganesh Green Bharat Limited	125.23	190.00	July 12, 2024	361.00	149.42% [-0.63%]	N.A.	N.A.
9.	Chetana Education Limited	45.90	85.00	July 31, 2024	98.90	N.A.	N.A.	N.A.
10.	Aprameya Engineering Limited	29.23	58.00	August 01, 2024	72.00	N.A.	N.A.	N.A.

Source: Price Information www.bseindia.com & www.nseindia.com, Issue Information from respective Prospectus.

- 1) The scrip of Amkay Products Limited, TGIF Agribusiness Limited & Energy-Mission Machinerics (India) Limited have not completed its 180th day from the date of listing; Aztec Fluids & Machinery Limited, Premier Roadlines Limited, Vilas Transcore Limited, Aimtron Electronics Limited & Ganesh Green Bharat Limited have not completed its 90th day from the date of listing and Chetana Education Limited & Aprameya Engineering Limited have not completed its 30th day from the date of listing.

Summary statement of Disclosure:

Financial Year	Total no. of IPOs	Total amount of funds raised (₹ Cr.)	No. of IPOs trading at discount- 30th calendar days from listing			No. of IPOs trading at Premium- 30th calendar days from listing			No. of IPOs trading at discount- 180th calendar days from listing			No. of IPOs trading at Premium- 180th calendar days from listing		
			Over 50%	Between 25-50%	Less than 25%	Over 50%	Between 25-50%	Less than 25%	Over 50%	Between 25-50%	Less than 25%	Over 50%	Between 25-50%	Less than 25%
2022-23	15 ⁽¹⁾	220.57	-	-	-	6	6	3	-	-	-	12	-	3
2023-24	21 ⁽²⁾	680.45	-	-	1	12	5	3	-	-	2	11	4	2
2024-25	12 ⁽³⁾	547.37	-	-	-	6	1	3	-	-	-	-	-	-

- 1) The scrip of Krishna Defence and Allied Industries Limited was listed on April 6, 2022; Eighty Jewellers Limited was listed on April 13, 2022; Kesar India Limited was listed on July 12, 2022; Silicon Rental Solutions Limited was listed on October 10, 2022; Cargosol Logistics Limited was listed on October 10, 2022; Cargotrans Maritime Limited was listed on October 10, 2022; Concord Control Systems Limited was listed on October 10, 2022; Lloyds Luxuries Limited was listed on October 11, 2022; Vedant Asset Limited was listed on October 12, 2022; Baheti Recycling Industries Limited was listed on December 08, 2022; Chaman Metallics Limited was listed on January 16, 2023; Earthstahl & Alloys Limited was listed on February 08, 2023; Macfos Limited was listed on March 01, 2023; Systango Technologies Limited was listed on March 15, 2023 and Labelkraft Technologies Limited was listed on March 23, 2023;
- 2) The scrip of Vasa Denticity Limited was listed on June 02, 2023; Hemant Surgical Industries Limited was listed on June 05, 2023; Greenchef Appliances Limited was listed on July 06, 2023; Kaka Industries Limited was listed on July 19, 2023; Asarfi Hospital Limited was listed on July 26, 2023; Kahan Packaging Limited was listed on September 15, 2023; Madhusudan Masala Limited was listed on September 26, 2023; Saakshi Medtech And Panels Limited was listed on October 03, 2023; Arabian Petroleum Limited was listed on October 09, 2023, E Factor Experiences Limited was listed on October 09, 2023, Paragon Fine and Speciality Chemical Limited was listed on November 03, 2023, Deepak Chemtex Limited was listed on December 06, 2023, S J Logistics (India) Limited was listed on December 19, 2023, Siyaram Recycling Industries Limited was listed on December 21, 2023, Shanti Spintex Limited was listed on December 27, 2023, Shri Balaji Valve Components Limited was listed on January 03, 2024, New Swan Multitech Limited was listed on January 18, 2024, Harshdeep Hortico Limited was listed on February 05, 2024, Megatherm Induction Limited was listed on February 05, 2024, Sona Machinery Limited was listed on March 13, 2024 and Enfuse Solutions Limited was listed on March 22, 2024;
- 3) The scrip of Aspire & Innovative Advertising Limited was listed on April 03, 2024, Blue Pebble Limited was listed on April 03, 2024, Amkay Products Limited was listed on May 08, 2024, TGIF Agribusiness Limited was listed on May 15, 2024, Energy-Mission Machinerics (India) Limited was listed on May 16, 2024, Aztec Fluids & Machinery Limited was listed on May 17, 2024, Premier Roadlines Limited was listed on May 17, 2024, Vilas Transcore Limited was listed on June 03, 2024, Aimtron Electronics Limited was listed on June 06, 2024; Ganesh Green Bharat Limited was listed on July 12, 2024; Chetana Education Limited was listed on July 31, 2024 and Aprameya Engineering Limited was listed on August 01, 2024.

Note:

- Based on date of listing.
- BSE SENSEX and CNX NIFTY have been considered as the benchmark index.
- Prices on BSE/NSE are considered for all of the above calculations.
- In case 30th /90th /180th day is not a trading day, closing price on BSE/NSE of the next trading day has been considered.
- In case 30th /90th /180th day, scrips are not traded then last trading price has been considered.
- N.A. – Period not completed.
- As per SEBI Circular No. CIR/CFD/DIL/7/2015 dated October 30, 2015, the above table should reflect max. 10 issues (initial public offerings) managed by the Book Running Lead Manager. Hence, disclosures pertaining to recent 10 issues handled by Book Running Lead Manager are provided.

Track Record of past issues handled by Hem Securities Limited

For details regarding track record of Book Running Lead Manager to the Issue as specified in the Circular reference no. CIR/MIRSD/1/2012 dated January 10, 2012 issued by the SEBI, please refer the website of the Book Running Lead Manager at www.hemsecurities.com.

Disclaimer from our Company and the Book Running Lead Manager

Our Company, the Directors and the Book Running Lead Manager accept no responsibility for statements made otherwise than those contained in this Prospectus or, in case of the Company, in the advertisements or any other material issued by or at the instance of the Company and anyone placing reliance on any other source of information would be doing so at their own risk.

The Book Running Lead Manager accept no responsibility, save to the limited extent as provided in the Agreement entered between the Book Running Lead Manager, and our Company on May 10, 2024 and the Underwriting Agreement dated June 25, 2024 entered into between the Underwriter, and our Company and the Market Making Agreement dated June 25, 2024 entered into among the Market Maker and our Company.

All information shall be made available by our Company, and the Book Running Lead Manager to the public and investors at large and no selective or additional information would be available for a section of the investors in any manner whatsoever including at road show presentations, in research or sales reports, at collection centres or elsewhere.

The Book Running Lead Manager and their respective associates and affiliates may engage in transactions with, and perform services for, our Company, our Promoter Group, Group Companies, or our affiliates or associates in the ordinary course of business and have engaged, or may in future engage, in commercial banking and investment banking transactions with our Company, our Promoter Group, Group Companies, and our affiliates or associates for which they have received and may in future receive compensation.

Note:

Investors who apply in the Issue will be required to confirm and will be deemed to have represented to our Company, and the Underwriter and their respective directors, officers, agents, affiliates and representatives that they are eligible under all applicable laws, rules, regulations, guidelines and approvals to acquire Equity Shares of our Company and will not offer, sell, pledge or transfer the Equity Shares of our Company to any person who is not eligible under applicable laws, rules, regulations, guidelines and approvals to acquire Equity Shares of our Company. Our Company, the Underwriter and their respective Directors, officers, agents, affiliates and representatives accept no responsibility or liability for advising any investor on whether such investor is eligible to acquire the Equity Shares in the issue.

Disclaimer in Respect of Jurisdiction

This Issue is being made in India to persons resident in India (including Indian nationals resident in India who are majors, HUFs, companies, corporate bodies and societies registered under applicable laws in India and authorized to invest in shares, Indian mutual funds registered with SEBI, Indian financial institutions, commercial banks, regional rural banks, cooperative banks (subject to RBI permission), or trusts under applicable trust law and who are authorized under their constitution to hold and invest in shares, public financial institutions as specified in Section 2(72) of the Companies Act, 2013, VCFs, state industrial development corporations, insurance companies registered with the Insurance Regulatory and Development Authority, provident funds (subject to applicable law) with a minimum corpus of ₹ 2,500.00 Lakhs and pension funds with a minimum corpus of ₹ 2,500.00 Lakhs, and permitted non-residents including FIIs, Eligible NRIs, multilateral and bilateral development financial institutions, FVCIs and eligible foreign investors, insurance funds set up and managed by army, navy or air force of the Union of India and insurance funds set up and managed by the Department of Posts, India provided that they are eligible under all applicable laws and regulations to hold Equity Shares of our Company. This Prospectus does not, however, constitute an offer to sell or an invitation to subscribe for Equity Shares offered hereby in any jurisdiction other than India to any person to whom it is unlawful to make an offer or invitation in such jurisdiction. Any person into whose possession this Prospectus comes is required to inform himself or herself about, and to observe, any such restrictions. Any dispute arising out of this Issue will be subject to jurisdiction of the competent court(s) in Jaipur, Rajasthan only.

No action has been, or will be, taken to permit a public offering in any jurisdiction where action would be required for that purpose. Accordingly, the Equity Shares represented hereby may not be offered or sold, directly or indirectly, and this Prospectus may not be distributed in any jurisdiction, except in accordance with the legal requirements applicable in such jurisdiction. Neither the

delivery of this Prospectus nor any sale hereunder shall, under any circumstances, create any implication that there has been no change in the affairs of our Company from the date hereof or that the information contained herein is correct as of any time subsequent to this date.

Disclaimer Clause of the SME Platform of NSE

As required, a copy of this Offer Document has been submitted to National Stock Exchange of India Limited (hereinafter referred to as NSE). NSE has given vide its letter Ref.: NSE/LIST/3907 dated July 29, 2024, permission to the Issuer to use the Exchange's name in this Offer Document as one of the Stock Exchanges on which this Issuer's securities are proposed to be listed. The Exchange has scrutinized this draft offer document for its limited internal purpose of deciding on the matter of granting the aforesaid permission to this Issuer. It is to be distinctly understood that the aforesaid permission given by NSE should not in any way be deemed or construed that the offer document has been cleared or approved by NSE; nor does it in any manner warrant, certify or endorse the correctness or completeness of any of the contents of this offer document; nor does it warrant that this Issuer's securities will be listed or will continue to be listed on the Exchange; nor does it take any responsibility for the financial or other soundness of this Issuer, its promoters, its management or any scheme or project of this Issuer.

Every person who desires to apply for or otherwise acquire any securities of this Issuer may do so pursuant to independent inquiry, investigation and analysis and shall not have any claim against the Exchange whatsoever by reason of any loss which may be suffered by such person consequent to or in connection with such subscription /acquisition whether by reason of anything stated or omitted to be stated herein or any other reason whatsoever.

Disclaimer Clause under Rule 144A of the U.S. Securities Act

The Equity Shares have not been, and will not be, registered under the U.S. Securities Act 1933, as amended (the "Securities Act") or any state securities laws in the United States and may not be offered or sold within the United States or to, or for the account or benefit of, "U.S. persons" (as defined in Regulations under the Securities Act), except pursuant to an exemption from, or in a transaction not subject to, the registration requirements of the Securities Act. Accordingly, the Equity Shares will be offered and sold outside the United States in compliance with Regulations of the Securities Act and the applicable laws of the jurisdiction where those offers and sales occur. The Equity Shares have not been, and will not be, registered, listed or otherwise qualified in any other jurisdiction outside India and may not be offered or sold, and Applications may not be made by persons in any such jurisdiction, except in compliance with the applicable laws of such jurisdiction.

Further, each Applicant where required agrees that such Applicant will not sell or transfer any Equity Shares or create any economic interest therein, including any off-shore derivative instruments, such as participatory notes, issued against the Equity Shares or any similar security, other than pursuant to an exemption from, or in a transaction not subject to, the registration requirements of the Securities Act and in compliance with applicable laws and legislations in each jurisdiction, including India.

Filing of Offer Document with the Designated Stock Exchange/SEBI/ROC

The Prospectus is being filed with Emerge Platform of National Stock Exchange of India Limited, Exchange Plaza, C-1, Block-G, Bandra Kurla Complex, Bandra (East), Mumbai 400051, Maharashtra, India.

The Draft Red Herring Prospectus will not be filed with SEBI, nor will SEBI issue any observation on the Offer Document in terms of Regulation 246(2) of SEBI (ICDR) Regulations, 2018. Pursuant to Regulation 246(5) of SEBI (ICDR) Regulations, 2018 and SEBI Circular Number SEBI/HO/CFD/DIL1/CIR/P/2018/011 dated January 19, 2018, a copy of Red Herring Prospectus/ Prospectus will be filed online through SEBI Intermediary Portal at <https://siportal.sebi.gov.in>.

A copy of the Red Herring Prospectus, along with the material contracts and documents required to be filed under Section 26 & 32 of the Companies Act, 2013 was filed to the RoC and a copy of the Prospectus to be filed under Section 26 of the Companies Act, 2013 will be filed to the RoC through the electronic portal at <http://www.mca.gov.in>.

Listing

The Equity Shares of our Company are proposed to be listed on SME Platform of NSE. Our Company has obtained in principle approval from NSE by way of its letter dated July 29, 2024 for listing of equity shares on NSE Emerge (SME Platform of NSE).

NSE will be the Designated Stock Exchange, with which the Basis of Allotment will be finalized for the Issue. If the permission to deal in and for an official quotation of the Equity Shares on the SME Platform is not granted by NSE, our Company shall forthwith

repay, all moneys received from the applicants in pursuance of the Prospectus. If such money is not repaid within the prescribed time, then our Company becomes liable to repay it, then our Company and every officer in default shall, shall be liable to repay such application money, with interest, as prescribed under the applicable law.

Our Company shall ensure that all steps for the completion of the necessary formalities for listing and commencement of trading at the NSE mentioned above are taken within Six (6) Working Days of the Bid/Issue Closing Date. If Equity Shares are not Allotted pursuant to the Issue within Six (6) Working Days from the Bid/Issue Closing Date or within such timeline as prescribed by the SEBI, our Company shall repay with interest all monies received from applicants, failing which interest shall be due to be paid to the applicants at the rate of 15% per annum for the delayed period.

Impersonation

Attention of the Applicants is specifically drawn to the provisions of sub-section (1) of Section 38 of the Companies Act, 2013 which is reproduced below:

Any person who-

- i. Makes or abets making of an application in a fictitious name to a company for acquiring, or subscribing for, its securities; or
- ii. Makes or abets making of multiple applications to a company in different names or in different combinations of his name or surname for acquiring or subscribing for its securities; or
- iii. Otherwise induces directly or indirectly a company to allot, or register any transfer of, securities to him, or to any other person in a fictitious name,

Shall be liable to action under section 447 of the Companies, Act 2013

Consents

Consents in writing of Our Directors, Our Promoter, Our Company Secretary & Compliance Officer, Chief Financial Officer, Our Statutory Auditor, Our Banker to the Company, Book Running Lead Manager, Registrar to the Issue, Legal Advisor to the Issue, Banker to the Issue/ Sponsor Bank, Syndicate Members, Underwriter to the Issue and Market Maker to the Issue to act in their respective capacities have been obtained as required under section 26 and 32 of the Companies Act, 2013 and shall be filed along with a copy of the Red Herring Prospectus/ Prospectus with the RoC, as required under Sections 32 of the Companies Act, 2013 and such consents was not withdrawn up to the time of filing of the Red Herring Prospectus/ Prospectus for filing with the RoC.

In accordance with the Companies Act and the SEBI (ICDR) Regulations, M/s. Abhishek Kumar & Associates, Chartered Accountants (FRN: 130052W), Statutory Auditor of the Company has agreed to provide their written consent to the inclusion of their respective reports on Statement of Possible Tax Benefits relating to the possible tax benefits and restated financial statements as included in this Offer Document in the form and context in which they appear therein and such consent and reports will not be withdrawn up to the time of filing of the Prospectus for filing with the RoC.

Experts Opinion

Except for the reports in the section “*Statement of Special Tax Benefits*”, “*Financial Information of the Company*” “*Statement of Financial Indebtedness*” on page 83, 144 and 182 respectively of this Prospectus from the Statutory Auditor, our Company has not obtained any expert opinions. We have received written consent from the Statutory Auditor for inclusion of their name in this Prospectus, as required under Companies Act read with SEBI (ICDR) Regulations as “Expert”, defined in section 2(38) of the Companies Act and such consent has not been withdrawn as on the date of this Prospectus. However, the term “**expert**” shall not be construed to mean an “**expert**” as defined under the U.S. Securities Act, 1933.

Fees, Brokerage and Selling Commission payable

The total fees payable to the Book Running Lead Manager will be as per the (i) Issue Agreement dated May 10, 2024 with the Book Running Lead Manager, (ii) the Underwriting Agreement dated June 25, 2024 with the Underwriter and (iii) the Market Making Agreement June 25, 2024 with the Market Maker, a copy of which is available for inspection at our Registered Office from 10.00 AM to 5.00 PM on Working Days from the date of the Prospectus until the Bid/Issue Closing Date.

Fees Payable to the Registrar to the Issue

The fees payable to the Registrar to the Issue for processing of applications, data entry, printing of CAN, tape and printing of bulk mailing register will be as per the agreement between our Company, and the Registrar to the Issue dated May 10, 2024, a copy of which is available for inspection at our Company's Registered Office.

The Registrar to the Issue will be reimbursed for all out-of-pocket expenses including cost of stationery, postage, stamp duty, and communication expenses. Adequate funds will be provided to the Registrar to the Issue to enable it to send allotment advice by registered post/speed post.

Particulars regarding Public or Rights Issues during the last five (5) years

Our Company has not made any previous public or rights issue in India or Abroad the five (5) years preceding the date of this Prospectus.

Previous issues of Equity Shares otherwise than for cash

For detailed description please refer to the section titled "*Capital Structure*" beginning on page 59 of this Prospectus.

Underwriting Commission, brokerage and selling commission on Previous Issues

Since this is the initial public offering of our Company's Equity Shares, no sum has been paid or has been payable as commission or brokerage for subscribing for or procuring or agreeing to procure subscription for any of the Equity Shares since our incorporation.

Previous capital issue during the last three years by listed Group Companies of our Company

We do not have any Group Company.

Performance vis-à-vis objects

Our Company is an "Unlisted Issuer" in terms of the SEBI (ICDR) Regulations, and this Issue is an "Initial Public Offering" in terms of the SEBI (ICDR) Regulations. Therefore, data regarding promise versus performance is not applicable to us.

Outstanding Debentures or Bond Issues or Redeemable Preference Shares

As on the date of this Prospectus, our Company has no outstanding debentures, bonds or redeemable preference shares.

Partly Paid-Up Shares

As on the date of this Prospectus, there are no partly paid-up Equity Shares of our Company.

Outstanding Convertible Instruments

Our Company does not have any outstanding convertible instruments as on the date of filing this Prospectus.

Option to Subscribe

- a. Investors will get the allotment of specified securities in dematerialization form only.
- b. The equity shares, on allotment, shall be traded on stock exchange in Demat segment only.

Stock Market Data for our Equity Shares

Our Company is an "Unlisted Issuer" in terms of the SEBI (ICDR) Regulations, and this Issue is an "Initial Public Offering" in terms of the SEBI (ICDR) Regulations. Thus, there is no stock market data available for the Equity Shares of our Company.

Mechanism for Redressal of Investor Grievances:

The agreement between the Registrar to the Issue and our Company provides for retention of records with the Registrar to the Issue for a period of at least three (3) years from the last date of dispatch of the letters of allotment and demat credit to enable the investors to approach the Registrar to the Issue for redressal of their grievances.

We hereby confirm that there are no investor complaints received during the three years preceding the filing of this Prospectus. Since there are no investor complaints received, none are pending as on the date of filing of this Prospectus.

Investors may contact the Book Running Lead Manager for any complaint pertaining to the Issue. All grievances, may be addressed to the Registrar to the Issue, with a copy to the relevant Designated Intermediary, where the Application Form was submitted, quoting the full name of the sole or first Applicant, Application Form number, Applicants' DP ID, Client ID, PAN, address of the Applicant, number of Equity Shares applied for, date of Application Form, name and address of the relevant Designated Intermediary, where the Bid was submitted and ASBA Account number in which the amount equivalent to the Bid Amount was blocked. Further, the Applicant shall enclose the Acknowledgement Slip or provide the acknowledgement number received from the Designated Intermediaries in addition to the documents/information mentioned hereinabove. Our Company, Book Running Lead Manager and the Registrar accept no responsibility for errors, omissions, commission of any acts of the Designated Intermediaries, including any defaults in complying with its obligations under the SEBI (ICDR) Regulations.

Disposal of Investor Grievances by our Company:

The Company has appointed Registrar to the Issue, to handle the investor grievances in co-ordination with our Company. All grievances relating to the present Issue may be addressed to the Registrar with a copy to the Compliance Officer, giving full details such as name, address of the Applicant, number of Equity Shares applied for, amount paid on application and name of bank and branch. The Company would monitor the work of the Registrar to the Issue to ensure that the investor grievances are settled expeditiously and satisfactorily. The Registrar to the Issue will handle investor's grievances pertaining to the Issue. A fortnightly status report of the complaints received and redressed by them would be forwarded to the Company. The Company would also be coordinating with the Registrar to the Issue in attending to the grievances to the investor.

All grievances relating to the ASBA process and UPI may be addressed to the SCSBs, giving full details such as name, address of the Applicant, number of Equity Shares applied for, amount paid on application and the Designated Branch of the SCSB where the Application Form was submitted by the ASBA Applicant. We estimate that the average time required by us or the Registrar to the Issue or the SCSBs for the redressal of routine investor grievances will be seven (7) business days from the date of receipt of the complaint. In case of non-routine complaints and complaints where external agencies are involved, we will seek to redress these complaints as expeditiously as possible.

The Registrar to the Issue shall obtain the required information from the SCSBs for addressing any clarifications or grievances of ASBA applicants or UPI Payment Mechanism Applicants. Our Company, the Book Running Lead Manager and the Registrar to the Issue accept no responsibility for errors, omissions, commission or any acts of SCSBs / Sponsor Bank including any defaults in complying with its obligations under applicable SEBI (ICDR) Regulations.

Our Company will obtain authentication on the SCORES in compliance with the SEBI circular (CIR/OIAE/1/2013) dated April 17, 2013, SEBI Circular (CIR/OIAE/1/2014) dated December 18, 2014, and SEBI circular (SEBI/HO/OIAE/IGRD/CIR/P/2021/642) dated October 14, 2021 in relation to redressal of investor grievances through SCORES. This would enable investors to lodge and follow up their complaints and track the status of redressal of such complaints from anywhere. For more details, investors are requested to visit the website www.scores.gov.in

Our Company has constituted a Stakeholders Relationship Committee of the Board vide resolution passed on May 08, 2024 For further details, please refer to section titled "**Our Management**" beginning on page 125 of this Prospectus.

Our Company has also appointed Nikita Sharma as the Company Secretary and Compliance Officer of our company, for this Issue he may be contacted in case of any pre-issue or post-issue related problems at the following address:

Nikita Sharma

Company Secretary & Compliance Officer

Sunlite Recycling Industries Limited

Survey No. 270A & Plot No. 1 Survey No. 267,
Chhatha Mile, Dantali, Vaso, Kheda -387350,
Gujarat, India.

Tel. No.: +91-9265111757

Email: cs@sunliteindustries.com

Website: www.sunliteindustries.com

Status of Investor Complaints

We confirm that we have not received any investor complaint during the three years preceding the date of this Prospectus and hence there are no pending investor complaints as on the date of this Prospectus.

Disposal of investor grievances by listed companies under the same management as our Company

We do not have any listed company under the same management.

Tax Implications

Investors who are allotted Equity Shares in the Issue will be subject to capital gains tax on any resale of the Equity Shares at applicable rates, depending on the duration for which the investors have held the Equity Shares prior to such resale and whether the Equity Shares are sold on the Stock Exchanges. For details, please refer the section titled “*Statement of Special Tax Benefits*” beginning on page 83 of this Prospectus.

Purchase of Property

Other than as disclosed in Section “*Our Business*” beginning on page 98 of this Prospectus there is no property which has been purchased or acquired or is proposed to be purchased or acquired which is to be paid for wholly or partly from the proceeds of the present Issue or the purchase or acquisition of which has not been completed on the date of this Prospectus.

Except as stated elsewhere in this Prospectus, our Company has not purchased any property in which the Promoter and/or Directors have any direct or indirect interest in any payment made there under.

Capitalization of Reserves or Profits

Save and except as stated in “*Capital Structure*” on page 59 of this Prospectus, our Company has not capitalized its reserves or profits at any time since inception.

Revaluation of assets

There has not been any revaluation of assets since incorporation of the Company.

Servicing Behavior

There has been no default in payment of statutory dues or of interest or principal in respect of our borrowings or deposits.

Payment or benefit to officers of Our Company

Except statutory benefits upon termination of their employment in our Company or superannuation, no officer of our Company is entitled to any benefit upon termination of his employment in our Company or superannuation.

Except as disclosed under chapter titled “*Our Management*” beginning on page 125 and chapter “*Financial Information*” beginning on page 144 of this Prospectus none of the beneficiaries of loans and advances and sundry debtors are related to the Directors of our Company.

Exemption from complying with any provisions of securities laws, if any

As on date of the Prospectus, our Company has not availed any exemption from complying with any provisions of securities laws granted by SEBI.

SECTION VIII: ISSUE RELATED INFORMATION

TERMS OF THE ISSUE

The Equity Shares being Issued are subject to the provisions of the Companies Act, SCRA, SCRR, SEBI (ICDR) Regulations, the SEBI Listing Regulations, our Memorandum and Articles of Association, the terms of the Prospectus, Prospectus, Application Form, any Confirmation of Allocation Note (“CAN”), the Revision Form, Allotment advices, and other terms and conditions as may be incorporated in the Allotment advices and other documents/certificates that may be executed in respect of the Issue. The Equity Shares shall also be subject to all applicable laws, guidelines, rules, notifications and regulations relating to the issue of capital and listing and trading of securities issued from time to time by SEBI, the GoI, the Stock Exchange, the RoC, the RBI and/or other authorities, as in force on the date of the Issue and to the extent applicable or such other conditions as may be prescribed by SEBI, RBI, the GoI, the Stock Exchange, the RoC and/or any other authorities while granting its approval for the Issue.

Please note that in terms of SEBI Circular No. CIR/CFD/POLICYCELL/11/2015 dated November 10, 2015 and the SEBI (Issue of Capital and Disclosure Requirements) Regulations, 2018, all the investors (except Anchor Investors) applying in a public Issue shall use only Application Supported by Blocked Amount (ASBA) process for application providing details of the bank account which will be blocked by the Self Certified Syndicate Banks (SCSBs) for the same. Further, pursuant to SEBI Circular No. SEBI/HO/CFD/DIL2/CIR/P/2018/138 dated November 01, 2018, Retail Individual Investors applying in public Issue may use either Application Supported by Blocked Amount (ASBA) facility for making application or also can use UPI as a payment mechanism with Application Supported by Blocked Amount for making application.

Further vide the said circular Registrar to the Issue and Depository Participants have been also authorized to collect the Bid-cum-Application forms. Investor may visit the official website of the concerned for any information on operational utilization of this facility of form collection by the Registrar to the Issue and Depository Participants as and when the same is made available.

Authority for the Issue

The present Public Issue of 28,80,000 Equity Shares has been authorized by a resolution of the Board of Directors of our Company at their meeting held on May 01, 2024 and was approved by the Shareholders of the Company by passing Special Resolution at the Extra Ordinary General Meeting held on May 06, 2024 in accordance with the provisions of Section 62(1)(c) of the Companies Act, 2013.

Ranking of Equity Shares

The Equity Shares being issued shall be subject to the provisions of the Companies Act, 2013 and our MOA and AOA and shall rank pari-passu in all respects with the existing Equity Shares of our Company including rights in respect of dividend. The Allottees, upon Allotment of Equity Shares under this Issue, will be entitled to receive dividends and other corporate benefits, if any, declared by our Company after the date of Allotment. For further details, please refer to section titled, “**Main Provisions of Article of Association**”, beginning on page 250 of this Prospectus.

Mode of Payment of Dividend

The declaration and payment of dividend will be as per the provisions of Companies Act, the Articles of Association, the provision of the SEBI (Listing Obligations and Disclosure Requirements) Regulations, 2015 and any other rules, regulations or guidelines as may be issued by the Government of India in connection thereto and as per the recommendation by the Board of Directors and the Shareholders at their discretion and will depend on a number of factors, including but not limited to earnings, capital requirements and overall financial condition of our Company. We shall pay dividends in cash and as per provisions of the Companies Act and our Articles of Association. Further Interim Dividend (if any declared) will be approved by the Board of Directors. For further details, please refer to section titled “**Dividend Policy**” and “**Main Provisions of Article of Association**” beginning on page 143 and 250 respectively of this Prospectus.

Face Value and Issue Price

The face value of each Equity Share is ₹10.00 and the Issue Price at the lower end of the Price Band is ₹100 per Equity Share (“Floor Price”) and at the higher end of the Price Band is ₹105 per Equity Share (“Cap Price”). The Anchor Investor Issue Price is ₹105 per Equity Share.

The Price Band and the minimum Bid Lot size were decided by our Company in consultation with the Book Running Lead Manager,

and has been advertised, at least two Working Days prior to the Bid/ Issue Opening Date, in all editions of Business Standard, an English national daily newspaper and all editions of Business Standard, a Hindi national daily newspaper and Gujarati edition of Ahmedabad Express, a regional newspaper each with wide circulation and shall be made available to the Stock Exchange for the purpose of uploading on its website. The Price Band, along with the relevant financial ratios calculated at the Floor Price and at the Cap Price, shall be pre filled in the Bid cum Application Forms available on the website of the Stock Exchange. The Issue Price shall be determined by our Company and in consultation with the Book Running Lead Manager, after the Bid/ Issue Closing Date, on the basis of assessment of market demand for the Equity Shares offered by way of Book Building Process. At any given point of time there shall be only one denomination of the Equity Shares of our Company, subject to applicable laws.

Compliance with SEBI (ICDR) Regulations, 2018

Our Company shall comply with all requirements of the SEBI (ICDR) Regulations. Our Company shall comply with all disclosure and accounting norms as specified by SEBI from time to time.

Compliance with Disclosure and Accounting Norms

Our Company shall comply with all disclosure and accounting norms as specified by SEBI from time to time.

Rights of the Equity Shareholders

Subject to applicable laws, rules, regulations and guidelines and the Articles of Association, the equity shareholders shall have the following rights:

- a) Right to receive dividend, if declared;
- b) Right to receive Annual Reports and notices to members;
- c) Right to attend general meetings and exercise voting rights, unless prohibited by law;
- d) Right to vote on a poll either in person or by proxy;
- e) Right to receive offer for rights shares and be allotted bonus shares, if announced;
- f) Right to receive surplus on liquidation; subject to any statutory or preferential claims being satisfied;
- g) Right of free transferability of the Equity Shares; and
- h) Such other rights, as may be available to a shareholder of a listed Public Limited Company under the Companies Act, terms of the SEBI (Listing Obligations and Disclosure Requirements) Regulations, 2015 and the Memorandum and Articles of Association of our Company.

For a detailed description of the main provision of the Articles of Association of our Company relating to voting rights, dividend, forfeiture and lien, transfer, transmission and/ or consolidation/ splitting, etc., please refer to section titled “*Main Provisions of the Articles of Association of our company*” beginning on page 250 of this Prospectus.

Minimum Application Value, Market Lot and Trading Lot

As per regulations made under and Section 29(1) of the Companies Act, 2013 the Equity Shares to be allotted must be in Dematerialized form i.e., not in the form of physical certificates but be fungible and be represented by the statement issued through electronic mode. Hence, the Equity Shares being issued can be applied for in the dematerialized form only. In this context, two agreements shall be signed among our Company, the respective Depositories and Registrar to the Issue.

- Tripartite Agreement dated March 07, 2024 between CDSL, Our Company and Registrar to the Issue; and
- Tripartite Agreement dated March 11, 2024 between NSDL, Our Company and Registrar to the Issue;

The trading of the Equity Shares will happen in the minimum contract size of 1200 Equity Shares and the same may be modified by the NSE (Emerge platform of NSE) from time to time by giving prior notice to investors at large.

Allocation and allotment of Equity Shares through this issue will be done in multiples of 1200 Equity Shares and is subject to a minimum allotment of 1200 Equity Shares to the successful applicants in terms of the SEBI circular No. CIR/MRD/DSA/06/2012 dated February 21, 2012.

Minimum Number of Allottees

In accordance with Regulation 268 of SEBI (ICDR) Regulations, 2018 the minimum number of allottees in the Issue shall be 50

shareholders. In case the minimum number of prospective allottees is less than 50, no allotment will be made pursuant to this Issue and the monies collected shall be unblocked forthwith.

Jurisdiction

Exclusive jurisdiction for the purpose of this Issue is with the competent courts/ authorities in Kheda, Gujarat.

The Equity Shares have not been, and will not be, registered under the U.S. Securities Act 1933, as amended (the “Securities Act”) or any state securities laws in the United States and may not be offered or sold within the United States or to, or for the account or benefit of, “U.S. persons” (as defined in Regulation S under the Securities Act), except pursuant to an exemption from, or in a transaction not subject to, the registration requirements of the Securities Act. Accordingly, the Equity Shares will be offered and sold outside the United States in compliance with Regulation S of the Securities Act and the applicable laws of the jurisdiction where those offers and sales occur.

The Equity Shares have not been, and will not be, registered, listed or otherwise qualified in any other jurisdiction outside India and may not be offered or sold, and Bids may not be made by persons in any such jurisdiction, except in compliance with the applicable laws of such jurisdiction.

Joint Holders

Where 2 (two) or more persons are registered as the holders of any Equity Shares, they will be deemed to hold such Equity Shares as joint-holders with benefits of survivorship.

Nomination Facility to Investor

In accordance with Section 72 of the Companies Act, 2013 the sole or first applicant, along with other joint applicant, may nominate any one person in whom, in the event of the death of sole applicant or in case of joint applicant, death of all the applicants, as the case may be, the Equity Shares allotted, if any, shall vest. A person, being a nominee, entitled to the Equity Shares by reason of the death of the original holder(s), shall in accordance with Section 72 of the Companies Act, 2013 be entitled to the same advantages to which he or she would be entitled if he or she were the registered holder of the Equity Share(s). Where the nominee is a minor, the holder(s) may make a nomination to appoint, in the prescribed manner, any person to become entitled to Equity Share(s) in the event of his or her death during the minority. A nomination shall stand rescinded upon a sale of equity share(s) by the person nominating. A buyer will be entitled to make a fresh nomination in the manner prescribed. Fresh nomination can be made only on the prescribed form available on request at the Registered Office of our Company or to the Registrar and Transfer Agents of our Company.

In accordance with Section 72 of the Companies Act, 2013 any Person who becomes a nominee by virtue of Section 72 of the Companies Act, 2013 shall upon the production of such evidence as may be required by the Board, elect either:

- a) to register himself or herself as the holder of the Equity Shares; or
- b) to make such transfer of the Equity Shares, as the deceased holder could have made.

Further, the Board may at any time give notice requiring any nominee to choose either to be registered himself or herself or to transfer the Equity Shares, and if the notice is not complied with within a period of 90 (ninety) days, the Board may thereafter withhold payment of all dividends, bonuses or other moneys payable in respect of the Equity Shares, until the requirements of the notice have been complied with.

Since the allotment of Equity Shares in the Issue is in dematerialized form, there is no need to make a separate nomination with us. Nominations registered with the respective depository participant of the applicant would prevail. If the investors require changing the nomination, they are requested to inform their respective depository participant.

Issue Program

Event	Indicative Date
Bid/Issue Opened Date	Monday, August 12, 2024
Bid/Issue Closed Date	Wednesday, August 14, 2024
Finalization of Basis of Allotment with the Designated Stock Exchange (T+1)	On or about Friday, August 16, 2024
Initiation of Allotment / Refunds / Unblocking of Funds from ASBA Account or UPI ID linked bank account (T+2)	On or about Friday, August 16, 2024

Event	Indicative Date
Credit of Equity Shares to Demat accounts of Allottees (T+2)	On or about Monday, August 19, 2024
Commencement of trading of the Equity Shares on the Stock Exchange (T+3)	On or about Tuesday, August 20, 2024

The above time table is indicative and does not constitute any obligation on our Company. Whilst our Company shall ensure that all steps for the completion of the necessary formalities for the listing and the commencement of trading of the Equity Shares on NSE is taken within Three Working Days from the Issue Closing Date, the timetable may change due to various factors, such as extension of the Issue Period by our Company or any delays in receiving the final listing and trading approval from the Stock Exchange. The Commencement of trading of the Equity Shares will be entirely at the discretion of the Stock Exchange and in accordance with the applicable laws.

*In case of any delay in unblocking of amounts in the ASBA Accounts (including amounts blocked through the UPI Mechanism) exceeding four Working Days from the Bid/ Issue Closing Date, the Bidder shall be compensated at a uniform rate of ₹100 per day for the entire duration of delay exceeding four Working Days from the Bid/ Issue Closing Date by the intermediary responsible for causing such delay in unblocking. The Book Running Lead Manager shall, in their sole discretion, identify and fix the liability on such intermediary or entity responsible for such delay in unblocking. For the avoidance of doubt, the provisions of the SEBI circular dated March 16, 2021, as amended pursuant to SEBI circular dated June 2, 2021 shall be deemed to be incorporated in the agreements to be entered into by and between the Company and the relevant intermediaries, to the extent applicable.

The above timetable is indicative and does not constitute any obligation on our Company or the Book Running Lead Manager. Whilst our Company shall ensure that all steps for the completion of the necessary formalities for the listing and the commencement of trading of the Equity Shares on the Stock Exchange are taken within three Working Days of the Bid/Issue Closing Date, the timetable may change due to various factors, such as extension of the Bid/Issue Period by our Company, revision of the Price Band or any delays in receiving the final listing and trading approval from the Stock Exchange. The Commencement of trading of the Equity Shares will be entirely at the discretion of the Stock Exchange and in accordance with the applicable laws.

Application Forms and any revisions to the same were accepted only between 10.00 A.M. to 5.00 P.M. (IST) during the Issue Period (except for the Bid/ Issue Closing Date). On the Bid/ Issue Closing Date, the Application Forms will be accepted only between 10.00 a.m. to 3.00 p.m. (IST) for retail and non-retail Applicants.

In accordance with SEBI (ICDR) Regulations, QIBs and Non-Institutional Bidders are not allowed to withdraw or lower the size of their Application (in terms of the quantity of the Equity Shares or the Application amount) at any stage. Retail Individual Bidders can revise or withdraw their Bid-Cum- Application Forms prior to the Bid/ Issue Closing Date. Allocation to Retail Individual Bidders, in this Issue will be on a proportionate basis.

In case of discrepancy in the data entered in the electronic book vis-à-vis the data contained in the physical Bid-Cum- Application Form, for a particular Bidder, the details as per the file received from Stock Exchange may be taken as the final data for the purpose of Allotment. In case of discrepancy in the data entered in the electronic book vis-à-vis the data contained in the physical or electronic Bid-Cum- Application Form, for a particular ASBA Bidder, the Registrar to the Issue shall ask the relevant SCSBs / RTAs / DPs / stock brokers, as the case may be, for the rectified data.

Minimum Subscription and Underwriting

This Issue is not restricted to any minimum subscription level and is 100% underwritten. As per Section 39 of the Companies Act, 2013, if the stated minimum amount has not been subscribed and the sum payable on application is not received within a period of 30 days from the date of the Prospectus, the application money has to be returned within such period as may be prescribed. If our Company does not receive the 100% subscription of the issue through the Issue Document including devolvement of Underwriters, if any, within sixty (60) days from the date of closure of the issue, our Company shall forthwith refund the entire subscription amount received. If there is a delay beyond eight days after our Company becomes liable to pay the amount, our Company and every officer in default will, on and from the expiry of this period, be jointly and severally liable to repay the money, with interest or other penalty as prescribed under the SEBI Regulations, the Companies Act 2013 and applicable law.

In terms of Regulation 272(2) of SEBI (ICDR) Regulations, in case the Company fails to obtain listing or trading permission from the stock exchanges where the specified securities are proposed to be listed, it shall refund through verifiable means the entire monies received within four days of receipt of intimation from stock exchange(s) rejecting the application for listing of specified securities, and if any such money is not repaid within four days after the issuer becomes liable to repay it, the issuer and every director of the company who is an officer in default shall, on and from the expiry of the fourth day, be jointly and severally liable to repay that money with interest at the rate of fifteen per cent per annum.

Further, in accordance with Regulation 268(1) of the SEBI (ICDR) Regulations, our Company shall ensure that the number of prospective allottees to whom the Equity Shares will allotted will not be less than 50 (Fifty).

In terms of Regulation 260 of the SEBI (ICDR) Regulations, 2018, the Issue is 100% underwritten. For details of underwriting arrangement, kindly refer the chapter titled “**General Information - Underwriting**” on page 54 of this Prospectus.

Further, in accordance with Regulation 267 of the SEBI (ICDR) Regulations, 2018, the minimum application size in terms of number of specified securities shall not be less than Rupees One Lakh per application.

Migration to Main Board

As per the provisions of the Chapter IX of the SEBI (ICDR) Regulation, 2018, our Company may migrate to the main board of NSE from the SME Exchange on a later date subject to the following:

If the Paid-up Capital of the company is likely to increase above ₹25 crores by virtue of any further issue of capital by way of rights, preferential issue, bonus issue etc. (which has been approved by a special resolution through postal ballot wherein the votes cast by the shareholders other than the promoter in favour of the proposal amount to at least two times the number of votes cast by shareholders other than promoter shareholders against the proposal and for which the company has obtained in-principal approval from the main board), we shall have to apply to NSE for listing our shares on its Main Board subject to the fulfillment of the eligibility criteria for listing of specified securities laid down by the Main Board.

If the Paid-up Capital of the company is more than ₹10 crores but below ₹25 crores, we may still apply for migration to the main board if the same has been approved by a special resolution through postal ballot wherein the votes cast by the shareholders other than the promoter in favour of the proposal amount to at least two times the number of votes cast by shareholders other than promoter shareholders against the proposal.

Market Making

The shares offered through this Issue are proposed to be listed on the NSE (Emerge platform of NSE), wherein the Book Running Lead Manager to this Issue shall ensure compulsory Market Making through the registered Market Makers of the SME Exchange for a minimum period of 3 (three) years from the date of listing on the Emerge platform of NSE.

For further details of the agreement entered into between the Company, the Book Running Lead Manager and the Market Maker please refer to section titled “**General Information - Details of the Market Making Arrangements for this Issue**” on page 55 of this Prospectus.

Arrangements for disposal of odd lots

The trading of the Equity Shares will happen in the minimum contract size of 1200 shares in terms of the SEBI circular No. CIR/MRD/DSA/06/2012 dated February 21, 2012. However, the Market Maker shall buy the entire shareholding of a shareholder in one lot, where value of such shareholding is less than the minimum contract size allowed for trading on the Emerge platform of National Stock Exchange of India Limited.

As per the extent Guideline of the Government of India, OCBs cannot participate in this Issue

The current provisions of the Foreign Exchange Management (Transfer or Issue of Security by a Person Resident outside India) Regulations, 2000, provides a general permission for the NRIs, FPIs and foreign venture capital investors registered with SEBI to invest in shares of Indian companies by way of subscription in an IPO. However, such investments would be subject to other investment restrictions under the Foreign Exchange Management (Transfer or Issue of Security by a Person Resident outside India) Regulations, 2000, RBI and/or SEBI regulations as may be applicable to such investors.

The Allotment of the Equity Shares to Non-Residents shall be subject to the conditions, if any, as may be prescribed by the Government of India/RBI while granting such approvals.

Allotment of Equity Shares in Dematerialized Form

Pursuant to Section 29 of the Companies Act, 2013, the Equity Shares in the Issue shall be allotted only in dematerialized form.

Further, as per the SEBI (ICDR) Regulations, the trading of the Equity Shares shall only be in dematerialized form on the Stock Exchange.

New Financial Instruments

There are no new financial instruments such as deep discounted bonds, debenture, warrants, secured premium notes, etc. issued by our Company through this Issue.

Application by Eligible NRI's, FPI's, VCF's, AIF's registered with SEBI

It is to be understood that there is no reservation for Eligible NRIs, FPIs or VCF registered with SEBI. Such Eligible NRIs, FPIs or VCF registered with SEBI will be treated on the same basis with other categories for the purpose of Allocation.

Restrictions on transfer and transmission of shares or debentures and on their consolidation or splitting

Except for lock-in of the Pre- Issue Equity Shares and Promoter minimum contribution in the Issue as detailed under section titled "**Capital Structure**" beginning on page 59 of this Prospectus, and except as provided in the Articles of Association of our Company, there are no restrictions on transfers of Equity Shares. There are no restrictions on transfer and transmission of shares/ debentures and on their consolidation/ splitting except as provided in the Articles of Association. For further details, please refer to section titled "**Main Provisions of the Articles of Association of our company**" beginning on page 250 of this Prospectus.

Pre-Issue Advertisement

Subject to Section 30 of the Companies Act 2013, our Company, after filing the Red Herring Prospectus with the ROC, publish a pre-Issue advertisement, in the form prescribed by the SEBI Regulations, in (i) All Editions of English National Newspaper, "**Business Standard**"; (ii) All editions of Hindi National Newspaper "**Business Standard**" and (iii) Gujarati edition of **Ahmedabad express**, regional newspaper (Gujarati being the regional language of Kheda where our registered office is located) each with wide circulation where the registered office of the company is situated. In the pre-Issue advertisement, we shall state the Bid/Issue Opening Date and the Bid/Issue Closing Date and the floor price or price band along with necessary details subject to regulation 250 of SEBI (ICDR) Regulations. This advertisement, subject to the provisions of section 30 of the Companies Act, 2013, shall be in the format prescribed in Part A of Schedule X of the SEBI Regulations.

In the pre-Issue advertisement, we stated the Bid/Issue Opening Date and the Bid/Issue Closing Date and the floor price or price band along with necessary details subject to regulation 250 of SEBI (ICDR) Regulations. This advertisement, subject to the provisions of section 30 of the Companies Act, 2013, was in the format prescribed in Part A of Schedule X of the SEBI Regulations.

Allotment Advertisement:

Our Company, the BRLM and the Registrar shall publish an allotment advertisement before commencement of trading, disclosing the date of commencement of trading in all editions of the English national newspaper i.e. "**Business Standard**", all editions of Hindi national newspaper i.e. "**Business Standard**" and Gujarati edition of **Ahmedabad express**, regional newspaper (Gujarati being the regional language of Kheda where our registered office is located) with wide circulation.

Withdrawal of the Issue

Our Company in consultation with the Book Running Lead Manager, reserve the right to not to proceed with the issue after the Bid/ Issue Opening date but before the Allotment. In such an event, our Company would issue a public notice in the newspaper in which the pre-issue advertisements were published, within two days of the Bid/ Issue Closing date or such other time as may be prescribed by SEBI, providing reasons for not proceeding with the issue. The Book Running Lead Manager through, the Registrar of the issue, shall notify the SCSBs to unblock the bank accounts of the ASBA Bidders within one working day from the date of receipt of such notification. Our Company shall also inform the same to the stock exchange on which equity shares are proposed to be listed.

ISSUE STRUCTURE

This Issue is being made in terms of Regulation 229(2) of Chapter IX of SEBI (ICDR) Regulations, 2018, as amended from time to time, whereby, an issuer whose post issue paid up capital is more than or equal to ten Crore rupees but less than twenty-five crore rupees, shall issue shares to the public and propose to list the same on the Small and Medium Enterprise Exchange (“**SME Exchange**”, in this case being the NSE Emerge i.e. Emerge platform of NSE). For further details regarding the salient features and terms of such an issue please refer chapter titled “**Terms of the Issue**” and “**Issue Procedure**” on page 218 and 227 of this Prospectus.

Issue Structure:

Initial Public Issue of 28,80,000 Equity Shares of ₹10 each (the “**Equity Shares**”) for cash at a price of ₹105 per Equity Share (including a Share Premium of ₹95 per Equity Share), aggregating up to ₹3024.00 Lakhs (“**the Issue**”) by the issuer Company (the “**Company**”). The Issue comprises a reservation of 1,48,800 Equity Shares of face value of ₹10.00/- each for cash at a price of ₹105 per equity share including a share premium of ₹95 per equity share aggregating to ₹156.24 Lakhs will be reserved for subscription by Market Maker to the issue (the “**Market Maker Reservation Portion**”).

The Issue less the Market Maker Reservation Portion i.e., Net Issue to Public of 27,31,200 Equity Shares of face value of ₹10.00/- each at a price of ₹105 per equity share including a share premium of ₹95 per equity share aggregating to ₹2867.76 lakhs (“**the Net Issue**”). The Issue and the Net Issue will constitute 26.47% and 25.10%, respectively of the post Issue paid up equity share capital of the Company. The Issue is being made through the Book Building Process.

Particulars of the Issue ⁽¹⁾	Market Maker Reservation Portion	QIBs	Non-Institutional Investors	Retail Individual Investors
Number of Equity Shares available for allocation	1,48,800 Equity Shares	Not more than 13,64,400 Equity Shares*	Not less than 4,10,400 Equity Shares*	Not less than 9,56,400 Equity Shares*
Percentage of Issue Size available for allocation	5.17% of the Issue Size	Not more than 50% of the Net Issue	Not less than 15% of the Net Issue	Not less than 35% of the Net Issue
Basis of Allotment⁽²⁾	Firm Allotment	Proportionate as follows (excluding the Anchor Investor Portion): 5,46,000 Equity Shares has been made available for allocation on a proportionate basis to all QIBs, 8,18,800 Equity Shares has been made available for allocation on a discretionary basis to Anchor Investors	Allotment to each Non-Institutional Bidder shall not be less than the Minimum NIB Application Size, subject to the availability of Equity Shares in the Non-Institutional Portion, and the remaining Equity Shares, if any, shall be allotted on a proportionate basis. For details, see “ Issue Procedure ” beginning on page 227 of this Prospectus.	Allotment to each Retail Individual Bidder shall not be less than the maximum Bid lot, subject to availability of Equity Shares in the Retail Portion and the remaining available Equity Shares is any, shall be allotted on proportionate basis. For details, see “ Issue Procedure ” beginning on page 227 of this Prospectus.
Mode of Allotment	Compulsorily in dematerialized form.			
Minimum Bid Size	1,48,800 Equity Shares	Such number of Equity Shares and in multiples of 1200 Equity Shares that the Bid Amount exceeds ₹200,000	Such number of Equity Shares and in multiples of 1200 Equity Shares that the Bid Amount exceeds ₹200,000	1200 Equity Shares
Maximum Bid Size	1,48,800 Equity Shares	Such number of Equity Shares in multiples of 1200 Equity Shares not	Such number of Equity Shares in multiples of 1200 Equity Shares not	Such number of Equity Shares in multiples of 1200 Equity Shares so that the

		exceeding the size of the Net Issue, subject to applicable limits	exceeding the size of the Net Issue (excluding the QIB portion), subject to applicable limits	Bid Amount does not exceed ₹200,000
Trading Lot	1200 Equity Shares, However the Market Maker may accept odd lots if any in the market as required under the SEBI (ICDR) Regulations, 2018.	1200 Equity Shares and in multiples thereof	1200 Equity Shares and in multiples thereof	1200 Equity Shares and in multiples thereof
Terms of Payment	Full Bid Amount shall be blocked by the SCSBs in the bank account of the ASBA Bidder (other than Anchor Investors) or by the Sponsor Bank through the UPI Mechanism, that is specified in the ASBA Form at the time of submission of the ASBA Form. In case of Anchor Investors: Full Bid Amount shall be payable by the Anchor Investors at the time of submission of their Bids ⁽³⁾			
Mode of Bid	Only through the ASBA process.	Only through the ASBA process. (Except for Anchor investors)	Only through the ASBA process	Through ASBA Process via Banks or by using UPI ID for payment

* Subject to finalization of basis of allotment.

This Issue is being made in terms of Chapter IX of the SEBI (ICDR) Regulations, 2018, as amended from time to time.

- (1) In terms of Rule 19(2) of the SCRR read with Regulation 252 of the SEBI (ICDR) Regulations, 2018 this is an Issue for at least 25% of the post issue paid-up Equity share capital of the Company. This Issue is being made through Book Building Process, wherein allocation to the public shall be as per Regulation 252 of the SEBI (ICDR) Regulations.
- (2) Subject to valid Bids being received at or above the Issue Price, undersubscription, if any, in any category, except in the QIB Portion, would be allowed to be met with spill-over from any other category or combination of categories of Bidders at the discretion of our Company in consultation with the Book Running Lead Manager and the Designated Stock Exchange, subject to applicable laws.
- (3) Full Bid Amount was payable by the Anchor Investors at the time of submission of the Anchor Investor Bid-cum- Application Forms provided that any difference between the Anchor Investor Allocation Price and the Anchor Investor Issue Price shall be payable by the Anchor Investor Pay-In Date as indicated in the CAN.

The Bids by FPIs with certain structures as described under “**Issue Procedure - Bids by FPIs**” on pages 227 and having same PAN may be collated and identified as a single Bid in the Bidding process. The Equity Shares Allocated and Allotted to such successful Bidders (with same PAN) may be proportionately distributed.

Withdrawal of the Issue

In accordance with SEBI (ICDR) Regulations, the Company, in consultation with the Book Running Lead Manager, reserves the right not to proceed with the Issue.

After Bid/Issue Opening but before allotment, and in such case the Company will give public notice giving reasons for withdrawal of Issue. The public notice will appear in two widely circulated national newspapers (*one each in English and Hindi*) and one in regional newspaper.

The Book Running Lead Manager, through the Registrar to the Issue, will instruct the SCSBs, to unblock the ASBA Accounts within one Working Day from the day of receipt of such instruction. The notice of withdrawal will be issued in the same newspapers where the pre-Issue advertisements have appeared and the Stock Exchange will also be informed promptly.

If our Company withdraws the Issue after the Bid/Issue Closing Date and subsequently decides to undertake a public offering of Equity Shares, our Company will file a fresh Red Herring Prospectus with the stock exchange where the Equity Shares may be proposed to be listed.

Notwithstanding the foregoing, the Issue is subject to obtaining (i) the final listing and trading approvals of the Stock Exchange, which our Company will apply for only after Allotment; and (ii) filing of the Red Herring Prospectus/ Prospectus with ROC.

Issue Program

Event	Indicative Dates
Bid/Issue Opening Date	Monday, August 12, 2024
Bid/Issue Closing Date	Wednesday, August 14, 2024
Finalization of Basis of Allotment with the Designated Stock Exchange (T+1)	On or about Friday, August 16, 2024
Initiation of Allotment / Refunds / Unblocking of Funds from ASBA Account or UPI ID linked bank account (T+2)	On or about Friday, August 16, 2024
Credit of Equity Shares to Demat accounts of Allottees (T+2)	On or about Monday, August 19, 2024
Commencement of trading of the Equity Shares on the Stock Exchange (T+3)	On or about Tuesday, August 20, 2024

Note Our Company, in consultation with the Book Running Lead Manager, considered participation by Anchor Investors in accordance with the SEBI (ICDR) Regulations. The Anchor Investor Bid/Issue Period closed one Working Day prior to the Bid/Issue Opening Date in accordance with the SEBI (ICDR) Regulations

ISSUE PROCEDURE

All Applicants should review the General Information Document for Investing in Public Issue, prepared and issued in accordance with the SEBI circular no CIR/CFD/DIL/12/2013 dated October 23, 2013 notified by SEBI and updated pursuant to SEBI Circular CIR/CFD/POLICYCELL/11/2015 dated November 10, 2015, the SEBI Circular SEBI/HO/CFD/DIL/CIR/P/2016/26 dated January 21, 2016, SEBI circular SEBI/HO/CFD/DIL2/CIR/P/2018/138 dated November 1, 2018 and updated pursuant to SEBI Circular SEBI/HO/CFD/DIL1/CIR/P/2020/37 dated March 17, 2020 (the “General Information Document”) which highlights the key rules, processes and procedures applicable to public issues in general in accordance with the provisions of the Companies Act, the SCRA, the SCRR and the SEBI ICDR Regulations. The General Information Document is available on the websites of Stock Exchange, the Company and the Lead Manager. Please refer to the relevant provisions of the General Information Document which are applicable to the Issue.

Additionally, all Applicants may refer to the General Information Document for information in relation to (i) Category of investor eligible to participate in the Issue; (ii) maximum and minimum Issue size; (iii) price discovery and allocation; (iv) Payment Instructions for ASBA Applicants; (v) Issuance of CAN and Allotment in the Issue; (vi) General instructions (limited to instructions for completing the Application Form); (vii) designated date; (viii) disposal of applications; (ix) submission of Application Form; (x) other instructions (limited to joint applications in cases of individual, multiple applications and instances when an application would be rejected on technical grounds); (xi) applicable provisions of Companies Act, 2013 relating to punishment for fictitious applications; (xii) mode of making refunds; and (xiv) interest in case of delay in Allotment or refund.

SEBI through its UPI Circular no. SEBI/HO/CFD/DIL2/CIR/P/2018/138 dated November 1, 2018 read with its circular no. SEBI/HO/CFD/DIL2/CIR/P/2019/50 dated April 3, 2019 and circular no. SEBI/HO/CFD/DIL2/CIR/P/2019/76 dated June 28, 2019, has introduced an alternate payment mechanism using Unified Payments Interface (UPI) and consequent reduction in timelines for listing in a phased manner. From January 1, 2019, the UPI Mechanism for RIIs applying through Designated Intermediaries was made effective along with the existing process and existing timeline of T+6 days (“UPI Phase I”). The UPI Phase I was effective till June 30, 2019.

Subsequently, for applications by Retail Individual Investors through Designated Intermediaries, the process of physical movement of forms from Designated Intermediaries to SCSBs for blocking of funds has been discontinued and only the UPI Mechanism with existing timeline of T+6 days is applicable for a period of three months or launch of five main board public issues, whichever is later (“UPI Phase II”), with effect from July 1, 2019, by SEBI circular (SEBI/HO/CFD/DIL2/CIR/P/2019/76) dated June 28, 2019, read with circular (SEBI/HO/CFD/DIL2/CIR/P/2019/85) dated July 26, 2019. Further, as per the SEBI circular (SEBI/HO/CFD/DCR2/CIR/P/2019/133) dated November 8, 2019, the UPI Phase II had been extended until March 31, 2020. However, due to the outbreak of COVID-19 pandemic, UPI Phase II has been further extended by SEBI until further notice, by its circular (SEBI/HO/CFD/DIL2/CIR/P/2020/50) dated March 30, 2020. Thereafter, the final reduced timeline of T+3 days may be made effective using the UPI Mechanism for applications by Retail Individual Investors (“UPI Phase III”), as may be prescribed by SEBI. Further, SEBI, vide its circular no. SEBI/HO/CFD/DIL2/CIR/P/2021/2480/1/M dated March 16, 2021, and circular no. SEBI/HO/CFD/DIL2/P/CIR/2021/570 dated June 2, 2021, has introduced certain additional measures for streamlining the process of initial public offers and redressing investor grievances. This circular is effective for initial public offers opening on/or after May 1, 2021, except as amended pursuant to SEBI circular SEBI/HO/CFD/DIL2/P/CIR/2021/570 dated June 2, 2021, and SEBI circular no. SEBI/HO/CFD/DIL2/CIR/P/2022/51 dated April 20, 2022, and the provisions of this circular are deemed to form part of this Offer Document. Furthermore, pursuant to SEBI circular no. SEBI/HO/CFD/DIL2/P/CIR/P/2022/45 dated April 5, 2022, all individual Investors in initial public offerings (opening on or after May 1, 2022) whose application sizes are up to ₹500,000 shall use the UPI Mechanism.

Furthermore, SEBI vide press release bearing number 12/2023 has approved the proposal for reducing the time period for listing of shares in public issue from existing 6 working days to 3 working days from the date of the closure of the issue. The revised timeline of T+3 days shall be made applicable in two phases i.e. voluntary for all public issues opening on or after September 1, 2023 and mandatory on or after December 1, 2023. Further, SEBI has vide its circular no. SEBI/HO/CFD/TPD1/CIR/P/2023/140 dated August 9, 2023 reduced the time taken for listing of specified securities after the closure of a public issue to three Working Days. Accordingly, the Offer will be made under UPI Phase III on a mandatory basis, subject to any circulars, clarification or notification issued by the SEBI from time to time.

The list of Banks that have been notified by SEBI as Issuer Banks for UPI are provided on <https://www.sebi.gov.in/sebiweb/other/OtherAction.do?doRecognisedFpi=yes&intmId=40>. The list of Stockbrokers, Depository Participants (DP), Registrar to an Issue and Share Transfer Agent (RTA) that have been notified by SME Platform of National Stock Exchange of India Limited (“NSE EMERGE”) to act as intermediaries for submitting Application Forms are provided on

www1.nseindia.com/emerge For details on their designated branches for submitting Application Forms, please see the above mentioned website of Platform of National Stock Exchange of India Limited (“NSE EMERGE”).

Please note that the information stated/covered in this section may not be complete and/or accurate and as such would be subject to modification/change. Our Company and Book Running Lead Manager do not accept any responsibility for the completeness and accuracy of the information stated in this section and the General Information Document. Our Company and Book Running Lead Manager would not be able to include any amendment, modification or change in applicable law, which may occur after the date of Prospectus. Applicants are advised to make their independent investigations and ensure that their application do not exceed the investment limits or maximum number of Equity Shares that can be held by them under applicable law or as specified in the Offer Document.

Further, the Company and the BRLM are not liable for any adverse occurrence’s consequent to the implementation of the UPI Mechanism for application in this Issue.

Phased implementation of Unified Payments Interface

SEBI has issued the UPI Circulars in relation to streamlining the process of public issue of inter alia, equity shares. Pursuant to the UPI Circulars, the UPI Mechanism has been introduced in a phased manner as a payment mechanism (in addition to mechanism of blocking funds in the account maintained with SCSBs under ASBA) for applications by RIBs through Designated Intermediaries with the objective to reduce the time duration from public issue closure to listing from six Working Days to up to three Working Days. Considering the time required for making necessary changes to the systems and to ensure complete and smooth transition to the UPI payment mechanism, the UPI Circulars have introduced the UPI Mechanism in three phases in the following manner:

Phase I: This phase was applicable from January 1, 2019 until March 31, 2019 or floating of five main board public issues, whichever is later. Subsequently, the timeline for implementation of Phase I was extended till June 30, 2019. Under this phase, an RII had the option to submit the ASBA Form with any of the Designated Intermediary and use his/ her UPI ID for the purpose of blocking of funds. The time duration from public Issue closure to listing continued to be six working days.

Phase II: This phase has become applicable from July 1, 2019. SEBI vide its circular no. SEBI/HO/CFD/DCR2/CIR/P/2019/133 dated November 8, 2019 had extended the timeline for implementation of UPI Phase II till March 31, 2020. Further, SEBI vide its circular no. SEBI/HO/CFD/DIL2/CIR/P/2020 dated March 30, 2020 decided to continue Phase II of UPI with ASBA until further notice. Under this phase, submission of the ASBA Form by RIBs through Designated Intermediaries (other than SCSBs) to SCSBs for blocking of funds will be discontinued and will be replaced by the UPI Mechanism. However, the time duration from public Issue closure to listing would continue to be six Working Days during this phase.

Phase III: This phase has become applicable on a voluntary basis for all issues opening on or after September 1, 2023 and on a mandatory basis for all issues opening on or after December 1, 2023, vide SEBI circular bearing number SEBI/HO/CFD/TPD1/CIR/P/2023/140 dated August 9, 2023 (“T+3 Notification”). In this phase, the time duration from public issue closure to listing has been reduced to three Working Days. The Issue shall be undertaken pursuant to the processes and procedures as notified in the T+3 Notification as applicable, subject to any circulars, clarification or notification issued by the SEBI from time to time, including any circular, clarification or notification which may be issued by SEBI.

The Issue is being made under Phase III of the UPI (on a mandatory basis).

All SCSBs offering facility of making application in public issues shall also provide facility to make application using the UPI Mechanism. The Issuers will be required to appoint one of the SCSBs as a sponsor bank to act as a conduit between the Stock Exchanges and NPCI in order to facilitate collection of requests and / or payment instructions of the Retail Individual Applicants into the UPI Mechanism.

For further details, refer to the General Information Document available on the websites of the Stock Exchanges and the Book Running Lead Manager.

PART A

Book Building Procedure

In terms of Rule 19(2)(b) of the Securities Contracts (Regulation) Rules, 1957, as amended (the “SCRR”) read with Regulation 252 of SEBI (ICDR) Regulations, 2018, the Issue is being made for at least 25% of the post-Issue Paid-up Equity Share capital of our

Company. The Issue is being made under Regulation 229(2) of Chapter IX of SEBI (Issue of Capital and Disclosure Requirements) Regulations, 2018 via book building process wherein not more than 50% of the Issue shall be allocated on a proportionate basis to QIBs, provided that our Company may, in consultation with the Book Running Lead Manager, allocate up to 60% of the QIB Portion to Anchor Investors on a discretionary basis in accordance with the SEBI (ICDR) Regulations, of which one-third shall be reserved for domestic Mutual Funds, subject to valid Bids being received from domestic Mutual Funds at or above the Anchor Investor Allocation Price. In the event of under-subscription, or non-allocation in the Anchor Investor Portion, the balance Equity Shares shall be added to the QIB Portion. Further, 5% of the QIB Portion (excluding the Anchor Investor Portion) shall be available for allocation on a proportionate basis only to Mutual Funds, and the remainder of the QIB Portion shall be available for allocation on a proportionate basis to all QIBs (other than Anchor Investors), including Mutual Funds, subject to valid Bids being received at or above the Issue Price. Further, not less than 15% of the Issue shall be available for allocation on a proportionate basis to Non Institutional Investors and not less than 35% of the Issue shall be available for allocation to Retail Individual Investors in accordance with the SEBI (ICDR) Regulations, subject to valid Bids being received at or above the Issue Price.

Subject to valid Bids being received at or above the Issue Price, undersubscription, if any, in any category, except the QIB Portion, would be allowed to be met with spill-over from any other category or a combination of categories at the discretion of our Company in consultation with the Book Running Lead Manager, and the Designated Stock Exchange. However, under-subscription, if any, in the QIB Portion will not be allowed to be met with spillover from other categories or a combination of categories.

The Equity Shares, on Allotment, shall be traded only in the dematerialised segment of the Stock Exchanges.

Bid cum Application Form

Copies of the Bid cum Application Form (other than for Anchor Investors) and the abridged prospectus were available at the offices of the Book Running Lead Manager, the Designated Intermediaries at Bidding Centres, and Registered Office of our Company. An electronic copy of the Bid cum Application Form was also available for download on the websites of the NSE, at least one day prior to the Bid/Issue Opening Date.

Copies of the Anchor Investor Application Form will be available at the offices of the Book Running Lead Manager.

All Bidders (other than Anchor Investors) shall mandatorily participate in the Issue only through the ASBA process. ASBA Bidders must provide either (i) the bank account details and authorisation to block funds in the ASBA Form, or (ii) the UPI ID, as applicable, in the relevant space provided in the ASBA Form. The ASBA Forms that do not contain such details are liable to be rejected. Applications made by the RIIs using third party bank account or using third party linked bank account UPI ID are liable for rejection. Anchor Investors are not permitted to participate in the Offer through the ASBA process. ASBA Bidders shall ensure that the Bids are made on ASBA Forms bearing the stamp of the relevant Designated Intermediary, submitted at the relevant Bidding Centres only (except in case of electronic ASBA Forms) and the ASBA Forms not bearing such specified stamp are liable to be rejected. Since the Offer is made under Phase III of the UPI Circulars, ASBA Bidders may submit the ASBA Form in the manner below:

- i. RIIs (other than the RIIs using UPI Mechanism) may submit their ASBA Forms with SCSBs (physically or online, as applicable), or online using the facility of linked online trading, demat and bank account (3 in 1 type accounts), provided by certain brokers.
- ii. RIIs using the UPI Mechanism, may submit their ASBA Forms with the Syndicate, sub-syndicate members, Registered Brokers, RTAs or CDPs, or online using the facility of linked online trading, demat and bank account (3 in 1 type accounts), provided by certain brokers.
- iii. QIBs and NIBs may submit their ASBA Forms with SCSBs, Syndicate, sub-syndicate members, Registered Brokers, RTAs or CDPs.

Anchor Investors were not permitted to participate in the Offer through the ASBA process.

The prescribed colour of the Bid cum Application Form for various categories is as follows:

Category	Colour*
Anchor Investor**	White
Indian Public / eligible NRI's applying on a non-repatriation basis (ASBA)	White
Non-Residents including eligible NRI's, FPI's, FIIs, FVCIs, etc. applying on a repatriation basis (ASBA)	Blue

*Excluding Electronic Bid cum Application Form

*** Bid cum application for for Anchor Investor was made available at the Office of the Book Running Lead Manager.*

Designated Intermediaries (other than SCSBs) after accepting Bid Cum Application Form submitted by RIIs (without using UPI for payment), NIIs and QIBs captured and uploaded the relevant details in the electronic bidding system of stock exchange(s) and shall submit/deliver the Bid Cum Application Forms to respective SCSBs where the Bidders has a bank account and shall not submit it to any non-SCSB Bank.

Further, for applications submitted to designated intermediaries (other than SCSBs), with use of UPI for payment, after accepting the Bid Cum Application Form, respective intermediary captured and uploaded the relevant application details, including UPI ID, in the electronic bidding system of stock exchange(s).

Bidders shall only use the specified Bid Cum Application Form for making an Application in terms of the Prospectus.

The Bid Cum Application Form shall contain information about the Bidder and the price and the number of Equity Shares that the Bidders wish to apply for. Bid Cum Application Forms downloaded and printed from the websites of the Stock Exchange shall bear a system generated unique application number. Bidders are required to ensure that the ASBA Account has sufficient credit balance as an amount equivalent to the full Application Amount can be blocked by the SCSB or Sponsor Bank at the time of submitting the Application.

An Investor, intending to subscribe to this Issue, shall submit a completed Bid Cum Application Form to any of the following intermediaries (Collectively called – Designated Intermediaries”)

Sr. No.	Designated Intermediaries
1.	An SCSB, with whom the bank account to be blocked, is maintained
2.	A syndicate member (or sub-syndicate member)
3.	A stock broker registered with a recognized stock exchange (and whose name is mentioned on the website of the stock exchange as eligible for this activity) ('broker')
4.	A depository participant ('DP') (whose name is mentioned on the website of the stock exchange as eligible for this activity)
5.	A registrar to an issue and share transfer agent ('RTA') (whose name is mentioned on the website of the stock exchange as eligible for this activity)

Retails investors submitting application with any of the entities at (ii) to (v) above (hereinafter referred as “Intermediaries”), and intending to use UPI, , were also required to enter their UPI ID in the Bid Cum Application Form.

The aforesaid intermediary shall, at the time of receipt of application, gave an acknowledgement to investor, by giving the counter foil or specifying the application number to the investor, as a proof of having accepted the Bid Cum Application Form, in physical or electronic mode, respectively.

The upload of the details in the electronic bidding system of stock exchange was done by:

For Applications submitted by Investors to SCSB	After accepting the form, SCSB shall capture and uploaded the relevant details in the electronic bidding system as specified by the stock exchange and began blocking funds available in the bank account specified in the form, to the extent of the application money specified.
For applications submitted by investors to intermediaries other than SCSBs	After accepting the Bid Cum Application Form, respective Intermediary captured and uploaded the relevant details in the electronic bidding system of the stock exchange. Post uploading, they shall forward a schedule as per prescribed format along with the Bid Cum Application Forms to designated branches of the respective SCSBs for blocking of funds within one day of closure of Issue.
For applications submitted by investors to intermediaries other than SCSBs with use of UPI for payment	After accepting the Bid Cum Application Form, respective intermediary shall capture and upload the relevant application details, including UPI ID, in the electronic bidding system of stock exchange. Stock exchange shared application details including the UPI ID with sponsor bank on a continuous basis, to enable sponsor bank to initiate mandate request on investors for blocking of funds. Sponsor bank initiated request for blocking of funds through NPCI to investor. Investor to accept mandate request for blocking of funds, on his/her mobile application, associated with UPI ID linked bank account.

Stock exchange validated the electronic bid details with depository's records for DP ID/Client ID and PAN, on a real-time basis and bring the inconsistencies to the notice of intermediaries concerned, for rectification and re-submission within the time specified by stock exchange.

Stock exchange allowed modification of selected fields viz. DP ID/Client ID or Pan ID (Either DP ID/Client ID or Pan ID can be modified but not BOTH), Bank code and Location code, in the bid details already uploaded.

Upon completion and submission of the Bid Cum Application Form to Application Collecting intermediaries, the Bidders authorized our Company to make the necessary changes in the Prospectus, without prior or subsequent notice of such changes to the Bidders.

The Sponsor Bank will undertake a reconciliation of Bid responses received from Stock Exchanges and sent to NPCI and will also ensure that all the responses received from NPCI are sent to the Stock Exchanges platform with detailed error code and description, if any. Further, the Sponsor Bank will undertake reconciliation of all Bid requests and responses throughout their lifecycle on daily basis and share reports with the Book Running Lead Manager in the format and within the timelines as specified under the UPI Circulars. Sponsor Bank and issuer banks shall download UPI settlement files and raw data files from the NPCI portal after every settlement cycle and do a three-way reconciliation with Banks UPI switch data, CBS data and UPI raw data. NPCI is to coordinate with issuer banks and Sponsor Banks on a continuous basis.

Participation by Promoters and members of the Promoter Group of our Company, the Book Running Lead Manager and the Syndicate Members

The Book Running Lead Manager and the Syndicate Member were not allowed to purchase Equity Shares in this Issue in any manner, except towards fulfilling their underwriting obligations. However, the associates and affiliates of the Book Running Lead Manager and the Syndicate Member Could Bid for Equity Shares in the Issue, either in the QIB Portion or in the Non-Institutional Portion as was applicable to such Bidders, where the allocation is on a proportionate basis and such subscription could be on their own account or on behalf of their clients. All categories of investors, including associates or affiliates of the Book Running Lead Manager and Syndicate Member, were required to be treated equally for the purpose of allocation to be made on a proportionate basis.

Except as stated below, neither the Book Running Lead Manager nor any associates of the Book Running Lead Manager could apply in the Issue under the Anchor Investor Portion:

- I. mutual funds sponsored by entities which are associate of the Book Running Lead Managers;
- II. insurance companies promoted by entities which are associate of the Book Running Lead Managers;
- III. AIFs sponsored by the entities which are associate of the Book Running Lead Managers; or
- IV. FPIs (other than individuals, corporate bodies and family offices) sponsored by the entities which are associate of the Book Running Lead Managers.

Further, persons related to our Promoters and Promoter Group did not apply in the Issue under the Anchor Investor Portion.

- I. rights under a shareholders' agreement or voting agreement entered into with our Promoters or Promoter Group;
- II. veto rights; or
- III. right to appoint any nominee director on the Board.

Further, an Anchor Investor was deemed to be an associate of the Book Running Lead Managers, if: (a) either of them controls, directly or indirectly through its subsidiary or holding company, not less than 15% of the voting rights in the other; or (b) either of them, directly or indirectly, by itself or in combination with other persons, exercises control over the other; or (c) there is a common director, excluding a nominee director, amongst the Anchor Investor and the Book Running Lead Manager.

Neither the Book Running Lead Manager nor any persons related to the Book Running Lead Manager (other than Mutual Funds sponsored by entities related to the Book Running Lead Manager), Promoters and Promoter Group can apply in the Issue under the Anchor Investor Portion.

Option to Subscribe in the Issue

- a. As per Section 29(1) of the Companies Act 2013, allotment of Equity Shares shall be made in dematerialized form only. Investors will not have the option of getting allotment of specified securities in physical form.
- b. The Equity Shares, on allotment, shall be traded on the Stock Exchange in demat segment only.
- c. A single application from any investor shall not exceed the investment limit/minimum number of Equity Shares that can be held by him/her/it under the relevant regulations/statutory guidelines and applicable law.

Information for the Bidders

The relevant Designated Intermediary could enter a maximum of three Bids at different price levels opted in the Bid cum Application Form and such options are not considered as multiple Bids. It was the Bidder's responsibility to obtain the acknowledgment slip from the relevant Designated Intermediary. The registration of the Bid by the Designated Intermediary does not guarantee that the Equity Shares shall be allocated/Allotted. Such Acknowledgement Slip will be non-negotiable and by itself will not create any obligation of any kind. When a Bidder revises his or her Bid, he /she was required to surrender the earlier Acknowledgement Slip and request for a revised acknowledgment slip from the relevant Designated Intermediary as proof of his or her having revised the previous Bid. In relation to electronic registration of Bids, the permission given by the Stock Exchanges to use their network and software of the electronic bidding system should not in any way be deemed or construed to mean that the compliance with various statutory and other requirements by our Company, the Book Running Lead Manager are cleared or approved by the Stock Exchanges; nor does it in any manner warrant, certify or endorse the correctness or completeness of compliance with the statutory and other requirements, nor does it take any responsibility for the financial or other soundness of our Company, the management or any scheme or project of our Company; nor does it in any manner warrant, certify or endorse the correctness or completeness of any of the contents of the Red Herring Prospectus and this Prospectus; nor does it warrant that the Equity Shares will be listed or will continue to be listed on the Stock Exchanges

BIDS BY ANCHOR INVESTORS:

Our Company in consultation with the Book Running Lead Manager, may consider participation by Anchor Investors in the Issue for up to 60% of the QIB Portion in accordance with the SEBI Regulations. Only QIBs as defined in Regulation 2(1)(ss) of the SEBI Regulations and not otherwise excluded pursuant to Schedule XIII of the SEBI Regulations are eligible to invest. The QIB Portion will be reduced in proportion to allocation under the Anchor Investor Portion. In the event of undersubscription in the Anchor Investor Portion, the balance Equity Shares will be added to the QIB Portion. In accordance with the SEBI Regulations, the key terms for participation in the Anchor Investor Portion are provided below.

- 1) Anchor Investor Bid cum Application Forms will be made available for the Anchor Investors at the offices of the Book Running Lead Manager.
- 2) The Bid must be for a minimum of such number of Equity Shares so that the Bid Amount is at least ₹200.00 lakhs. A Bid cannot be submitted for over 60% of the QIB Portion. In case of a Mutual Fund, separate Bids by individual schemes of a Mutual Fund will be aggregated to determine the minimum application size of ₹200.00 lakhs
- 3) One-third of the Anchor Investor Portion will be reserved for allocation to domestic Mutual Funds.
- 4) Bidding for Anchor Investors will open one Working Day before the Bid/ Issue Opening Date and be completed on the same day.
- 5) Our Company in consultation with the Book Running Lead Manager, will finalize allocation to the Anchor Investors on a discretionary basis, provided that the minimum and maximum number of Allottees in the Anchor Investor Portion will be, as mentioned below:
 - where allocation in the Anchor Investor Portion is up to ₹ 200.00 Lakhs, maximum of 2 (two) Anchor Investors.
 - where the allocation under the Anchor Investor Portion is more than ₹ 200.00 Lakhs but upto ₹ 2500.00 Lakhs, minimum of 2 (two) and maximum of 15 (fifteen) Anchor Investors, subject to a minimum Allotment of ₹ 100.00 Lakhs per Anchor Investor; and

- where the allocation under the Anchor Investor portion is more than ₹ 2500.00 Lakhs: (i) minimum of 5 (five) and maximum of 15 (fifteen) Anchor Investors for allocation upto ₹ 2500.00 Lakhs; and (ii) an additional 10 Anchor Investors for every additional allocation of ₹ 2500.00 Lakhs or part thereof in the Anchor Investor Portion; subject to a minimum Allotment of ₹ 100.00 Lakhs per Anchor Investor.
- 6) Allocation to Anchor Investors will be completed on the Anchor Investor Bid/ Issue Period. The number of Equity Shares allocated to Anchor Investors and the price at which the allocation is made will be made available in the public domain by the Book Running Lead Manager before the Bid/Issue Opening Date, through intimation to the Stock Exchange.
 - 7) Anchor Investors cannot withdraw or lower the size of their Bids at any stage after submission of the Bid.
 - 8) If the Issue Price is greater than the Anchor Investor Allocation Price, the additional amount being the difference between the Issue Price and the Anchor Investor Allocation Price will be payable by the Anchor Investors within 2 (two) Working Days from the Bid/ Issue Closing Date. If the Issue Price is lower than the Anchor Investor Allocation Price, Allotment to successful Anchor Investors will be at the higher price, i.e., the Anchor Investor Issue Price.
 - 9) At the end of each day of the bidding period, the demand including allocation made to anchor investors, shall be shown graphically on the bidding terminals of syndicate members and website of stock exchange offering electronically linked transparent bidding facility, for information of public.
 - 10) 50% of the Equity Shares Allotted to Anchor Investors in the Anchor Investor Portion shall be locked in for a period of 90 days from the date of Allotment, while the remaining 50% of the Equity Shares Allotted to Anchor Investors in the Anchor Investor Portion shall be locked in for a period of 30 days from the date of Allotment.
 - 11) The Book Running Lead Manager, our Promoters, Promoter Group or any person related to them (except for Mutual Funds sponsored by entities related to the Book Running Lead Manager) will not participate in the Anchor Investor Portion. The parameters for selection of Anchor Investors will be clearly identified by the Book Running Lead Manager and made available as part of the records of the Book Running Lead Manager for inspection by SEBI.
 - 12) Bids made by QIBs under both the Anchor Investor Portion and the QIB Portion will not be considered multiple Bids.
 - 13) Anchor Investors are not permitted to Bid in the Issue through the ASBA process.

BIDS BY ELIGIBLE NRIS:

Eligible NRIs may obtain copies of Bid cum Application Form from the offices of the Book Running Lead Manager and the Designated Intermediaries. Eligible NRI Bidders bidding on a repatriation basis by using the Non- Resident Forms should authorize their SCSB to block their Non-Resident External (“NRE”) accounts, or Foreign Currency Non-Resident (“FCNR”) ASBA Accounts, and eligible NRI Bidders bidding on a non-repatriation basis by using Resident Forms should authorize their SCSB to block their Non- Resident Ordinary (“NRO”) accounts for the full Bid Amount, at the time of the submission of the Bid cum Application Form.

- Eligible NRIs bidding on non-repatriation basis are advised to use the Bid cum Application Form for residents (white in colour).
- Eligible NRIs bidding on a repatriation basis are advised to use the Bid cum Application Form meant for Non-Residents (blue in colour).

BIDS BY FPI INCLUDING FIIS:

In terms of the SEBI FPI Regulations, any qualified foreign investor or FII who holds a valid certificate of registration from SEBI shall be deemed to be an FPI until the expiry of the block of three years for which fees have been paid as per the SEBI FII Regulations. An FII or a sub-account may participate in this Issue, in accordance with Schedule 2 of the FEMA Regulations, until the expiry of its registration with SEBI as an FII or a sub-account. An FII shall not be eligible to invest as an FII after registering as an FPI under the SEBI FPI Regulations.

In case of Bids made by FPIs, a certified copy of the certificate of registration issued by the designated depository participant under the FPI Regulations is required to be attached to the Bid cum Application Form, failing which our Company reserves the right to reject any Bid without assigning any reason. An FII or subaccount may, subject to payment of conversion fees under the SEBI FPI

Regulations, participate in the Issue, until the expiry of its registration as a FII or sub-account, or until it obtains a certificate of registration as FPI, whichever is earlier. Further, in case of Bids made by SEBI-registered FIIs or sub-accounts, which are not registered as FPIs, a certified copy of the certificate of registration as an FII issued by SEBI is required to be attached to the Bid cum Application Form, failing which our Company reserves the right to reject any Bid without assigning any reason.

In terms of the SEBI FPI Regulations, the Issue of Equity Shares to a single FPI or an investor group (which means the same set of ultimate beneficial owner(s) investing through multiple entities) must be below 10% of our post-Issue Equity Share capital. Further, in terms of the FEMA Regulations, the total holding by each FPI shall be below 10% of the total paid-up Equity Share capital of our Company and the total holdings of all FPIs put together shall not exceed 24% of the paid-up Equity Share capital of our Company. The aggregate limit of 24% may be increased up to the sectorial cap by way of a resolution passed by the Board of Directors followed by a special resolution passed by the Shareholders of our Company and subject to prior intimation to RBI. In terms of the FEMA Regulations, for calculating the aggregate holding of FPIs in a company, holding of all registered FPIs as well as holding of FIIs (being deemed FPIs) shall be included. The existing individual and aggregate investment limits an FII or sub account in our Company is 10% and 24% of the total paid-up Equity Share capital of our Company, respectively.

FPIs are permitted to participate in the Issue subject to compliance with conditions and restrictions which may be specified by the Government from time to time.

Subject to compliance with all applicable Indian laws, rules, regulations, guidelines and approvals in terms of Regulation 22 of the SEBI FPI Regulations, an FPI, other than Category III foreign portfolio and unregulated broad based funds, which are classified as Category II foreign portfolio investor by virtue of their investment manager being appropriately regulated, may issue or otherwise deal in offshore derivative instruments (as defined under the SEBI FPI Regulations as any instrument, by whatever name called, which is issued overseas by an FPI against securities held by it that are listed or proposed to be listed on any recognized stock exchange in India, as its underlying) directly or indirectly, only in the event (i) such offshore derivative instruments are issued only to persons who are regulated by an appropriate regulatory authority; and (ii) such offshore derivative instruments are issued after compliance with know your client norms. An FPI is also required to ensure that no further issue or transfer of any offshore derivative instrument is made by or on behalf of it to any persons that are not regulated by an appropriate foreign regulatory authority.

FPIs who wish to participate in the Issue are advised to use the Bid cum Application Form for Non- Residents (blue in colour).

BIDS BY SEBI REGISTERED VCF'S, AIF'S AND FVCI'S:

The SEBI FVCI Regulations and the SEBI AIF Regulations inter-alia prescribe the investment restrictions on the VCFs, FVCIs and AIFs registered with SEBI. Further, the SEBI AIF Regulations prescribe, among others, the investment restrictions on AIF's.

The holding by any individual VCF registered with SEBI in one venture capital undertaking should not exceed 25% of the corpus of the VCF. Further, VCFs and FVCIs can invest only up to 33.33% of the investible funds by way of subscription to an initial public offering.

The category I and II AIFs cannot invest more than 25% of the corpus in one Investee Company. A category III AIF cannot invest more than 10% of the corpus in one Investee Company. A venture capital fund registered as a category I AIF, as defined in the SEBI AIF Regulations, cannot invest more than 1/3rd of its corpus by way of subscription to an initial public offering of a venture capital undertaking. Additionally, the VCFs which have not re-registered as an AIF under the SEBI AIF Regulations shall continue to be regulated by the VCF Regulation until the existing fund or scheme managed by the fund is wound up and such funds shall not launch any new scheme after the notification of the SEBI AIF Regulations.

All FIIs and FVCIs should note that refunds, dividends and other distributions, if any, will be payable in Indian Rupees only and net of Bank charges and commission.

Our Company or the Book Running Lead Manager will not be responsible for loss, if any, incurred by the Bidder on account of conversion of foreign currency.

There was no reservation for Eligible NRIs, FPIs and FVCIs and all Bidders will be treated on the same basis with other categories for the purpose of allocation.

BIDS BY HUF'S:

Hindu Undivided Families or HUFs, in the individual name of the Karta. The Bidder should specify that the Application is being made in the name of the HUF in the Bid cum Application Form as follows: "Name of sole or first Applicant: XYZ Hindu Undivided

Family applying through XYZ, where XYZ is the name of the Karta". Bid cum Applications by HUFs may be considered at par with Bid cum Applications from individuals.

BIDS BY MUTUAL FUNDS:

No Mutual Fund scheme shall invest more than 10% of its net asset value in equity shares or equity related instruments of any single company provided that the limit of 10% shall not be applicable for investments in index funds or sector or industry specific funds. No Mutual Fund under all its schemes should own more than 10% of any company's paid-up share capital carrying voting rights.

With respect to Bids by Mutual Funds, a certified copy of their SEBI registration certificate must be lodged with the Bid cum Application Form. Failing this, our Company reserves the right to accept or reject any Bid cum Application in whole or in part, in either case, without assigning any reason thereof.

In case of a mutual fund, a separate Bid cum Application can be made in respect of each scheme of the mutual fund registered with SEBI and such Applications in respect of more than one scheme of the mutual fund will not be treated as multiple applications provided that the Bids clearly indicate the scheme concerned for which the Bids has been made.

The Bids made by the asset management companies or custodians of Mutual Funds shall specifically state the names of the concerned schemes for which the Applications are made.

BIDS BY SYSTEMATICALLY IMPORTANT NON BANKING FINANCIAL COMPANIES:

In case of Applications made by Systemically Important Non-Banking Financial Companies, a certified copy of the certificate of registration issued by the RBI, a certified copy of its last audited financial statements on a standalone basis and a net worth certificate from its statutory auditor(s), must be attached to the Bid cum Application Form. Failing this, our Company reserve the right to reject any Application, without assigning any reason thereof. Systemically Important Non-Banking Financial Companies participating in the Issue shall comply with all applicable legislations, regulations, directions, guidelines and circulars issued by RBI from time to time.

BIDS BY LIMITED LIABILITY PARTNERSHIPS:

In case of Bids made by limited liability partnerships registered under the Limited Liability Partnership Act, 2008, a certified copy of certificate of registration issued under the Limited Liability Partnership Act, 2008, must be attached to the Bid cum Application Form. Failing this, our Company reserves the right to reject any bid without assigning any reason thereof. Limited liability partnerships can participate in the Issue only through the ASBA process.

BIDS BY INSURANCE COMPANIES:

In case of Bids made by insurance companies registered with the IRDA, a certified copy of certificate of registration issued by IRDA must be attached to the Bid cum Application Form. Failing this, our Company reserves the right to reject any Bid by Insurance Companies without assigning any reason thereof. The exposure norms for insurers, prescribed under the Insurance Regulatory and Development Authority (Investment) Regulations, 2000, as amended, are broadly set forth below:

- 1) equity shares of a company: the least of 10% of the investee company's subscribed capital (face value) or 10% of the respective fund in case of life insurer or 10% of investment assets in case of general insurer or reinsurer;
- 2) the entire group of the investee company: not more than 15% of the respective fund in case of a life insurer or 15% of investment assets in case of a general insurer or reinsurer or 15% of the investment assets in all companies belonging to the group, whichever is lower; and
- 3) the industry sector in which the investee company belong to: not more than 15% of the fund of a life insurer or a general insurer or a reinsurer or 15% of the investment asset, whichever is lower.

The maximum exposure limit, in the case of an investment in equity shares, cannot exceed the lower of an amount of 10% of the investment assets of a life insurer or general insurer and the amount calculated under (1), (2) and (3) above, as the case may be. Insurance companies participating in this Issue shall comply with all applicable regulations, guidelines and circulars issued by IRDAI from time to time.

BIDS UNDER POWER OF ATTORNEY:

In case of Bids made pursuant to a power of attorney or by limited companies, corporate bodies, registered societies, FIIs, Mutual Funds, insurance companies and provident funds with a minimum corpus of ₹ 2500 Lakhs (subject to applicable law) and pension funds with a minimum corpus of ₹2500 Lakhs, a certified copy of the power of attorney or the relevant resolution or authority, as the case may be, along with a certified copy of the memorandum of association and articles of association and/or bye laws must be lodged along with the Bid cum Application Form. Failing this, our Company reserves the right to accept or reject any Bid in whole or in part, in either case, without assigning any reasons thereof. In addition to the above, certain additional documents are required to be submitted by the following entities:

- a) With respect to Bids by FIIs and Mutual Funds, a certified copy of their SEBI registration certificate must be lodged along with the Bid cum Application Form.
- b) With respect to Bids by insurance companies registered with the Insurance Regulatory and Development Authority, in addition to the above, a certified copy of the certificate of registration issued by the Insurance Regulatory and Development Authority must be lodged along with the Bid cum Application Form.
- c) With respect to Bids made by provident funds with a minimum corpus of ₹ 2500 Lakhs (subject to applicable law) and pension funds with a minimum corpus of ₹ 2500 Lakhs, a certified copy of a certificate from a chartered accountant certifying the corpus of the provident fund/pension fund must be lodged along with the Bid cum Application Form.
- d) With respect to Bids made by limited liability partnerships registered under the Limited Liability Partnership Act, 2008, a certified copy of certificate of registration issued under the Limited Liability Partnership Act, 2008, must be attached to the Bid cum Application Form
- e) Our Company in consultation with the Book Running Lead Manager in their absolute discretion, reserves the right to relax the above condition of simultaneous lodging of the power of attorney along with the Bid cum Application form, subject to such terms and conditions that our Company and the Book Running Lead Manager may deem fit.

The above information is given for the benefit of the Bidders. Our Company, the Book Running Lead Manager and the Syndicate Members are not liable for any amendments or modification or changes in applicable laws or regulations, which may occur after the date of the Prospectus. Bidders are advised to make their independent investigations and Bidders are advised to ensure that any single Bid from them does not exceed the applicable investment limits or maximum number of Equity Shares that can be held by them under applicable law or regulation or as specified in the Prospectus.

BIDS BY PROVIDENT FUNDS / PENSION FUNDS:

In case of Bids made by provident funds with minimum corpus of ₹25 Crore (subject to applicable law) and pension funds with minimum corpus of ₹25 Crore, a certified copy of certificate from a chartered accountant certifying the corpus of the provident fund/ pension fund must be lodged along with the Bid cum Application Form. Failing this, the Company reserves the right to accept or reject any bid in whole or in part, in either case, without assigning any reason thereof.

BIDS BY BANKING COMPANY:

In case of Bids made by banking companies registered with RBI, certified copies of: (i) the certificate of registration issued by RBI, and (ii) the approval of such banking company's investment committee are required to be attached to the Bid cum Application Form, failing which our Company reserves the right to reject any Bid by a banking company without assigning any reason.

The investment limit for banking companies in non-financial services companies as per the Banking Regulation Act, 1949, as amended (the "Banking Regulation Act"), and the Reserve Bank of India (Financial Services provided by Banks) Directions, 2016, is 10% of the paid-up share capital of the investee company not being its subsidiary engaged in non-financial services or 10% of the banks' own paid-up share capital and reserves, whichever is lower. However, a banking company would be permitted to invest in excess of 10% but not exceeding 30% of the paidup share capital of such investee company if (i) the investee company is engaged in non-financial activities permitted for banks in terms of Section 6(1) of the Banking Regulation Act, or (ii) the additional acquisition is through restructuring of debt / corporate debt restructuring / strategic debt restructuring, or to protect the banks' interest on loans / investments made to a company. The bank is required to submit a time bound action plan for disposal of such shares within a specified period to RBI. A banking company would require a prior approval of RBI to make (i) investment in a subsidiary and a financial services company that is not a subsidiary (with certain exception prescribed), and (ii) investment in a

nonfinancial services company in excess of 10% of such investee company's paid up share capital as stated in 5(a)(v)(c)(i) of the Reserve Bank of India (Financial Services provided by Banks) Directions, 2016.

BIDS BY SCSB'S:

SCSBs participating in the Issue are required to comply with the terms of the SEBI circulars dated September 13, 2012 and January 2, 2013. Such SCSBs are required to ensure that for making Bid cum Applications on their own account using ASBA, they should have a separate account in their own name with any other SEBI registered SCSBs. Further, such account shall be used solely for the purpose of making Bid cum application in public issues and clear demarcated funds should be available in such account for such Bid cum applications.

ISSUANCE OF A CONFIRMATION NOTE ("CAN") AND ALLOTMENT IN THE ISSUE:

1. Upon approval of the basis of allotment by the Designated Stock Exchange, the Book Running Lead Manager or Registrar to the Issue shall send to the SCSBs a list of their Bidders who have been allocated Equity Shares in the Issue.
2. The Registrar will then dispatch a CAN to their Bidders who have been allocated Equity Shares in the Issue. The dispatch of a CAN shall be deemed a valid, binding and irrevocable contract for the Bidder

Issue Procedure for Application Supported by Blocked Account (ASBA) Bidders

In accordance with the SEBI Circular No. CIR/CFD/POLICYCELL/11/2015 dated November 10, 2015 all the Bidders have to compulsorily apply through the ASBA Process. Our Company and the Book Running Lead Manager were not liable for any amendments, modifications, or changes in applicable laws or regulations, which may occur after the date of this Prospectus. ASBA Bidders were advised to make their independent investigations and to ensure that the ASBA Bid Cum Application Form is correctly filled up, as described in this section.

The lists of banks that have been notified by SEBI to act as SCSB (Self Certified Syndicate Banks) for the ASBA Process are provided on <https://www.sebi.gov.in/sebiweb/other/OtherAction.do?doRecognised=yes>. For details on designated branches of SCSB collecting the Bid Cum Application Form, please refer the above-mentioned SEBI link.

Terms of payment

The entire Issue price of ₹105 per share is payable on application. In case of allotment of lesser number of Equity Shares than the number applied, the Registrar shall instruct the SCSBs to unblock the excess amount paid on Application to the Bidders.

SCSBs will transfer the amount as per the instruction of the Registrar to the Public Issue Account, the balance amount after transfer will be unblocked by the SCSBs.

The Bidders should note that the arrangement with Bankers to the Issue or the Registrar is not prescribed by SEBI and has been established as an arrangement between our Company, Banker to the Issue and the Registrar to the Issue to facilitate collections from the Bidders.

Payment mechanism

The Bidders shall specify the bank account number in their Bid Cum Application Form and the SCSBs shall block an amount equivalent to the Application Amount in the bank account specified in the Bid Cum Application Form. The SCSB shall keep the Application Amount in the relevant bank account blocked until withdrawal/ rejection of the Application or receipt of instructions from the Registrar to unblock the Application Amount. However, Non-Retail Bidders shall neither withdraw nor lower the size of their applications at any stage. In the event of withdrawal or rejection of the Bid Cum Application Form or for unsuccessful Bid Cum Application Forms, the Registrar to the Issue shall give instructions to the SCSBs to unblock the application money in the relevant bank account within one day of receipt of such instruction. The Application Amount shall remain blocked in the ASBA Account until finalization of the Basis of Allotment in the Issue and consequent transfer of the Application Amount to the Public Issue Account, or until withdrawal/ failure of the Issue or until rejection of the Application by the ASBA Bidder, as the case may be.

Please note that, in terms of SEBI Circular No. CIR/CFD/POLICYCELL/11/2015 dated November 10, 2015 and the SEBI (Issue of Capital and Disclosure Requirements) Regulations, 2018, all the investors applying in a public Issue shall use only Application

Supported by Blocked Amount (ASBA) process for application providing details of the bank account which will be blocked by the Self-Certified Syndicate Banks (SCSBs) for the same. Further, pursuant to SEBI Circular No. SEBI/HO/CFD/DIL2/CIR/P/2018/138 dated November 01, 2018, Retail Individual Investors applying in public Issue have to use UPI as a payment mechanism with Application Supported by Blocked Amount for making application.

Payment into Escrow Account for Anchor Investors

All the investors other than Anchor Investors are required to bid through ASBA Mode. Anchor Investors are requested to note the following:

Our Company in consultation with the Book Running Lead Manager, in its absolute discretion, will decide the list of Anchor Investors to whom the CAN was sent, pursuant to which the details of the Equity Shares allocated to them in their respective names was notified to such Anchor Investors. For Anchor Investors, the payment instruments for payment into the Escrow Account should be drawn in favour of:

- a) In case of resident Anchor Investors: **SUNLITE RECYCLING INDUSTRIES LTD- R ANCHOR A/C**
- b) In case of Non-Resident Anchor Investors: **SUNLITE RECYCLING INDUSTRIES LTD- NR ANCHOR A/C**

Bidders should note that the escrow mechanism is not prescribed by SEBI and has been established as an arrangement between our Company, the Syndicate, the Escrow Collection Bank and the Registrar to the Issue to facilitate collections from the Anchor Investors.

Build of the Book

- a) Bids received from various Bidders through the Designated Intermediaries may be electronically uploaded on the Bidding Platform of the Stock Exchange on a regular basis. The book gets built up at various price levels. This information may be available with the Book Running Lead Manager at the end of the Bid/ Issue Period.
- b) Based on the aggregate demand and price for Bids registered on the Stock Exchange Platform, a graphical representation of consolidated demand and price as available on the websites of the Stock Exchange may be made available at the Bidding centres during the Bid/ Issue Period.

Withdrawal of Bids

- a) RIIs can withdraw their Bids until Bid/ Issue Closing Date. In case a RII wishes to withdraw the Bid during the Bid/ Issue Period, the same can be done by submitting a request for the same to the concerned Designated Intermediary who shall do the requisite, including unblocking of the funds by the SCSB in the ASBA Account.
- b) The Registrar to the Issue shall give instruction to the SCSB for unblocking the ASBA Account on the Designated Date. QIBs and NIIs can neither withdraw nor lower the size of their Bids at any stage.

Signing of Underwriting Agreement and Filing of Red Herring Prospectus/ Prospectus with RoC

- a) Our company has entered into an Underwriting Agreement dated June 25, 2024.
- b) A copy of Red Herring Prospectus was filed with the RoC and copy of Prospectus will be filed with RoC in terms of Section 32 of Companies Act, 2013 and Section 26 of Companies Act, 2013.

Pre-Issue Advertisement

Subject to Section 30 of the Companies Act 2013, our Company shall, after filing the Red Herring Prospectus with the ROC, published a pre-Issue advertisement, in the form prescribed by the SEBI (ICDR) Regulations, in (i) English National Newspaper; (ii) Hindi National Newspaper and (iii) Regional Newspaper each with wide circulation. In the pre-Issue advertisement, we shall state the Bid Opening Date and the Bid/Issue Closing Date and the floor price or price band along with necessary details subject to regulation 250 of SEBI (ICDR) Regulations. This advertisement, subject to the provisions of section 30 of the Companies Act, 2013, shall be in the format prescribed in Part A of Schedule X of the SEBI Regulations.

GENERAL INSTRUCTIONS:

Please note that the NIIs are not permitted to withdraw their bids or lower the size of Bids in terms of quantity of Equity Shares or Bid Amount) at any stage. Retail Individual Investor can revise their Bids during the Bid/Issue period and withdraw their Bids until Bid/issue Closing date.

Anchor investors are not allowed to withdraw their Bids after Anchor Investors bidding date.

Do's:

1. Check if you are eligible to apply as per the terms of the Prospectus and under applicable law, rules, regulations, guidelines and approvals;
2. Ensure that you have Bid within the Price Band;
3. Read all the instructions carefully and complete the Bid cum Application Form in the prescribed form;
4. Ensure that the details about the PAN, DP ID, Client ID, UPI ID are correct and the Bidders depository account is active, as Allotment of the Equity Shares will be in the dematerialized form only;
5. Ensure that your Bid cum Application Form bearing the stamp of a Designated Intermediary is submitted to the Designated Intermediary at the Bidding Centre;
6. If the first applicant is not the account holder, ensure that the Bid cum Application Form is signed by the account holder. Ensure that you have mentioned the correct bank account number in the Bid cum Application Form;
7. In case of Joint bids, ensure the first bidder is the ASBA Account holder (or the UPI linked bank account holder, as the case may be) and the signature of the first bidder is included in the Bid cum Application Form;
8. QIBs, Non-Institutional Bidders and the Retail Bidders should submit their Bids through the ASBA process only. However, pursuant to SEBI circular dated November 01, 2018, RII may submit their bid by using UPI mechanism for payment.
9. Ensure that the name(s) given in the Bid cum Application Form is/are exactly the same as the name(s) in which the beneficiary account is held with the Depository Participant. In case of joint Bids, the Bid cum Application Form should contain only the name of the First Bidder whose name should also appear as the first holder of the beneficiary account held in joint names;
10. Ensure that you request for and receive a stamped acknowledgement of the Bid cum Application Form for all your Bid options;
11. Ensure that you have funds equal to the Bid Amount in the Bank Account maintained with the SCSB before submitting the Bid cum Application Form under the ASBA process or application forms submitted by RIIs using UPI mechanism for payment, to the respective member of the Syndicate (in the Specified Locations), the SCSBs, the Registered Broker (at the Broker Centers), the RTA (at the Designated RTA Locations) or CDP (at the Designated CDP Locations);
12. Submit revised Bids to the same Designated Intermediary, through whom the original Bid was placed and obtain a revised acknowledgment;
13. Except for Bids (i) on behalf of the Central or State Governments and the officials appointed by the courts, who, in terms of a SEBI circular dated June 30, 2008, may be exempt from specifying their PAN for transacting in the securities market, and (ii) Bids by persons resident in the state of Sikkim, who, in terms of a SEBI circular dated July 20, 2006, may be exempted from specifying their PAN for transacting in the securities market, all Bidders should mention their PAN allotted under the IT Act. The exemption for the Central or the State Government and officials appointed by the courts and for investors residing in the State of Sikkim is subject to (a) the Demographic Details received from the respective depositories confirming the exemption granted to the beneficiary owner by a suitable description in the PAN field and the beneficiary account remaining in "active status"; and (b) in the case of residents of Sikkim, the address as per the Demographic Details evidencing the same. All other applications in which PAN is not mentioned will be rejected;
14. Ensure that the Demographic Details are updated, true and correct in all respects;
15. Ensure that the signature of the First Bidder in case of joint Bids, is included in the Bid cum Application Forms;
16. Ensure that thumb impressions and signatures other than in the languages specified in the Eighth Schedule to the Constitution of India are attested by a Magistrate or a Notary Public or a Special Executive Magistrate under official seal;
17. Ensure that the category and the investor status is indicated;
18. Ensure that in case of Bids under power of attorney or by limited companies, corporate, trust etc., relevant documents are submitted;
19. Ensure that Bids submitted by any person outside India should be in compliance with applicable foreign and Indian laws;
20. Bidders should note that in case the DP ID, Client ID and the PAN mentioned in their Bid cum Application Form and entered into the online IPO system of the Stock Exchange by the relevant Designated Intermediary, as the case may be, do not match with the DP ID, Client ID and PAN available in the Depository database, then such Bids are liable to be rejected. Where the Bid cum Application Form is submitted in joint names, ensure that the beneficiary account is also held in the same joint names and such names are in the same sequence in which they appear in the Bid cum Application Form;

21. Ensure that the Bid cum Application Forms are delivered by the Bidders within the time prescribed as per the Bid cum Application Form and the Prospectus;
 22. Ensure that you have mentioned the correct ASBA Account number or UPI ID in the Bid cum Application Form;
 23. Ensure that you have mentioned the details of your own bank account for blocking of fund or your own bank account linked UPI ID to make application in the Public Issue;
 24. Ensure that on receipt of the mandate request from sponsor bank, you have taken necessary step in timely manner for blocking of fund on your account through UPI ID using UPI application;
 25. Ensure that you have correctly signed the authorization / undertaking box in the Bid cum Application Form, or have otherwise provided an authorization to the SCSB via the electronic mode, for blocking funds in the ASBA Account equivalent to the Bid Amount mentioned in the Bid cum Application Form at the time of submission of the Bid;
 26. Ensure that you receive an acknowledgement from the concerned Designated Intermediary, for the submission of your Bid cum Application Form; and
 27. The Bid cum Application Form is liable to be rejected if the above instructions, as applicable, are not complied with.
- The Bid cum Application Form is liable to be rejected if the above instructions, as applicable, are not complied with.

Don'ts:

1. Do not Bid for lower than the minimum Bid size;
2. Do not Bid / revise Bid Amount to less than the Floor Price or higher than the Cap Price;
3. Do not pay the Bid Amount in cash, by money order, cheques or demand drafts or by postal order or by stock invest;
4. Do not send Bid cum Application Forms by post; instead submit the same to the Designated Intermediary only;
5. Do not submit the Bid cum Application Forms to any non-SCSB bank or our Company;
6. Do not Bid on a Bid cum Application Form that does not have the stamp of the relevant Designated Intermediary;
7. Do not Bid at Cut-off Price (for Bids by QIBs and Non-Institutional Bidders);
8. Do not instruct your respective Banks to release the funds blocked in the ASBA Account under the ASBA process;
9. Do not Bid for a Bid Amount exceed ₹ 2,00,000/- (for Applications by Retail Individual Bidders);
10. Do not fill up the Bid cum Application Form such that the Equity Shares Application exceeds the Issue size and / or investment limit or maximum number of the Equity Shares that can be held under the applicable laws or regulations or maximum amount permissible under the applicable regulations or under the terms of the Prospectus;
11. Do not submit the General Index Register number instead of the PAN;
12. Do not submit the Bid without ensuring that funds equivalent to the entire Bid Amount are blocked in the relevant ASBA Account;
13. Do not submit Bids on plain paper or on incomplete or illegible Bid cum Application Forms or on Bid cum Application Forms in a colour prescribed for another category of Applicant;
14. Do not submit a Bid in case you are not eligible to acquire Equity Shares under applicable law or your relevant constitutional documents or otherwise;
15. Do not Bid if you are not competent to contract under the Indian Contract Act, 1872 (other than minors having valid depository accounts as per Demographic Details provided by the depository);
16. Do not submit a Bid by using details of the third party's bank account or UPI ID which is linked with bank account of the third party. Kindly note that Bids made using third party bank account or using third party linked bank account UPI ID are liable for rejection.

The Bid cum Application Form is liable to be rejected if the above instructions, as applicable, are not complied with.

Names of entities responsible for finalising the basis of allotment in a fair and proper manner

The authorised employees of the Designated Stock Exchange, along with the BRLMs and the Registrar, shall ensure that the basis of allotment is finalised in a fair and proper manner in accordance with the procedure specified in SEBI ICDR Regulations.

Method of allotment as may be prescribed by SEBI from time to time

Our Company will not make any allotment in excess of the Equity Shares offered through the Issue through the Issue document except in case of oversubscription for the purpose of rounding off to make allotment, in consultation with the Designated Stock Exchange. Further, upon oversubscription, an allotment of not more than 1% of the net Issue to public may be made for the purpose of making allotment in minimum lots.

The allotment of Equity Shares to applicants other than to the Retail Individual Investors shall be on a proportionate basis within the respective investor categories and the number of securities allotted shall be rounded off to the nearest integer, subject to minimum allotment being equal to the minimum application size as determined and disclosed.

The allotment of Equity Shares to each Retail Individual Investor shall not be less than the minimum bid lot, subject to the availability of shares in Retail Individual Investor category, and the remaining available shares, if any, shall be allotted on a proportionate basis.

Investor Grievance

In case of any pre-issue or post issue related problems regarding demat credit/ refund orders/ unblocking etc. the Investors can contact the Compliance Officer of our Company.

Nomination Facility to Bidders

Nomination facility is available in accordance with the provisions of Section 72 of the Companies Act, 2013. In case of allotment of the Equity Shares in dematerialized form, there is no need to make a separate nomination as the nomination registered with the Depository may prevail. For changing nominations, the Bidders should inform their respective DP.

GROUND OF TECHNICAL REJECTIONS

Bidders are advised to note that Bids are liable to be rejected inter alia on the following technical grounds:

- Amount blocked does not tally with the amount payable for the Equity Shares applied for;
- In case of partnership firms, Equity Shares may be registered in the names of the individual partners and no firm as such shall be entitled to apply;
- Bid by persons not competent to contract under the Indian Contract Act, 1872 including minors, insane persons;
- PAN not mentioned in the Bid cum Application Form;
- Bids at a price less than the Floor Price and Bids at a price more than the Cap Price;
- GIR number furnished instead of PAN;
- Bid for lower number of Equity Shares than specified for that category of investors;
- Bids at Cut-off Price by NIIs and QIBs;
- Bids for number of Equity Shares which are not in multiples of Equity Shares as specified in the Prospectus;
- The amounts mentioned in the Bid cum Application Form/Application Form does not tally with the amount payable for the value of the Equity Shares Bid/Applied for;
- Bids for lower number of Equity Shares than the minimum specified for that category of investors;
- Category not ticked;
- Multiple Bids as defined in the Prospectus;
- In case of Bids under power of attorney or by limited companies, corporate, trust etc., where relevant documents are not submitted;
- Bid accompanied by Stock invest/ money order/ postal order/ cash/ cheque/ demand draft/ pay order;
- Signature of sole Bidder is missing;
- Bid cum Application Forms not delivered by the Bidder within the time prescribed as per the Bid cum Application Forms, Bid/Issue Opening Date advertisement and the Prospectus and as per the instructions in the Prospectus and the Bid cum Application Forms;
- In case no corresponding record is available with the Depositories that matches three parameters namely, names of the Bidders (including the order of names of joint holders), the Depository Participant's identity (DP ID) and the beneficiary's account number;
- Bids for amounts greater than the maximum permissible amounts prescribed by the regulations;
- Bid by OCBs;
- Bids by US persons other than in reliance on Regulation S or "qualified institutional buyers" as defined in Rule 144A under the Securities Act;
- Inadequate funds in the bank account to block the Bid Amount specified in the Bid cum Application Form/Application Form at the time of blocking such Bid Amount in the bank account;
- Bids not uploaded on the terminals of the Stock Exchanges;
- Where no confirmation is received from SCSB for blocking of funds;

- Bids by SCSBs wherein a separate account in its own name held with any other SCSB is not mentioned as the ASBA Account in the Bid cum Application Form/Application Form. Bids not duly signed by the sole/First Bidder;
- Bids by any persons outside India if not in compliance with applicable foreign and Indian laws;
- Bids that do not comply with the securities laws of their respective jurisdictions are liable to be rejected;
- Bids by persons prohibited from buying, selling or dealing in the shares directly or indirectly by SEBI or any other regulatory authority;
- Bids by persons who are not eligible to acquire Equity Shares of the Company in terms of all applicable laws, rules, regulations, guidelines, and approvals; and
- Details of ASBA Account not provided in the Bid cum Application form.

For details of instructions in relation to the Bid cum Application Form, Bidders may refer to the relevant section the GID.

BIDDERS SHOULD NOTE THAT IN CASE THE PAN, THE DP ID AND CLIENT ID MENTIONED IN THE BID CUM APPLICATION FORM AND ENTERED INTO THE ELECTRONIC APPLICATION SYSTEM OF THE STOCK EXCHANGES BY THE BIDS COLLECTING INTERMEDIARIES DO NOT MATCH WITH PAN, THE DP ID AND CLIENT ID AVAILABLE IN THE DEPOSITORY DATABASE, THE BID CUM APPLICATION FORM IS LIABLE TO BE REJECTED.

BASIS OF ALLOCATION

- a) The SEBI (ICDR) Regulations specify the allocation or Allotment that may be made to various categories of Bidders in an Issue depending on compliance with the eligibility conditions. Certain details pertaining to the percentage of Issue size available for allocation to each category is disclosed overleaf of the Bid cum Application Form and in the Prospectus. For details in relation to allocation, the Bidder may refer to the Prospectus.
- b) Under-subscription in any category (except QIB Category) is allowed to be met with spill over from any other category or combination of categories at the discretion of the Issuer and in consultation with the Book Running Lead Manager and the Designated Stock Exchange and in accordance with the SEBI (ICDR) Regulations, Unsubscribed portion in QIB Category is not available for subscription to other categories.
- c) In case of under subscription in the issue, spill-over to the extent of such under- subscription may be permitted from the Reserved Portion to the Issue. For allocation in the event of an under-subscription applicable to the Issuer, Bidders may refer to the Prospectus.

ALLOTMENT PROCEDURE AND BASIS OF ALLOTMENT

The Allotment of Equity Shares to Bidders other than Retail Individual Investors and Anchor Investors may be on proportionate basis. For Basis of Allotment to Anchor Investors, Bidders may refer to Prospectus. No Retail Individual Investor will be Allotted less than the minimum Bid Lot subject to availability of shares in Retail Individual Investor Category and the remaining available shares, if any will be Allotted on a proportionate basis. The Issuer is required to receive a minimum subscription of 90% of the Issue. However, in case the Issue is in the nature of Offer for Sale only, then minimum subscription may not be applicable.

Flow of Events from the closure of Bidding period (T DAY) Till Allotment:

- On T Day, RTA to validate the electronic bid details with the depository records and also reconcile the final certificates received from the Sponsor Bank for UPI process and the SCSBs for ASBA and Syndicate ASBA process with the electronic bid details
- RTA identifies cases with mismatch of account number as per bid file / FC and as per applicant's bank account linked to depository demat account and seek clarification from SCSB to identify the applications with third party account for rejection.
- Third party confirmation of applications to be completed by SCSBs on T+1 day.
- RTA prepares the list of final rejections and circulate the rejections list with BRLM(s)/ Company for their review/ comments.
- Post rejection, the RTA submits the basis of allotment with the Designated Stock Exchange (DSE).
- The DSE, post verification approves the basis and generates drawal of lots wherever applicable, through a random number generation software.
- The RTA uploads the drawal numbers in their system and generates the final list of allottees as per process mentioned below.

Process for generating list of Allottees: -

- Instruction is given by RTA in their Software System to reverse category wise all the application numbers in the ascending order and generate the bucket /batch as per the allotment ratio. For example, if the application number is 78654321 then system reverses it to 12345687 and if the ratio of allottees to applicants in a category is 2:7 then the system will create lots of 7. If the drawal of lots provided by Designated Stock Exchange (DSE) is 3 and 5 then the system will pick every 3rd and 5th application in each of the lot of the category and these applications will be allotted the shares in that category.
- In categories where there is proportionate allotment, the Registrar will prepare the proportionate working based on the oversubscription times.
- In categories where there is undersubscription, the Registrar will do full allotment for all valid applications.
- On the basis of the above, the RTA will work out the allottees, partial allottees and non- allottees, prepare the fund transfer letters and advice the SCSBs to debit or unblock the respective accounts.

BASIS OF ALLOTMENT

a. For Retail Individual Bidders

Bids received from the Retail Individual Bidders at or above the Issue Price shall be grouped together to determine the total demand under this category. The Allotment to all the successful Retail Individual Bidders will be made at the Issue Price.

The Issue size less Allotment to Non-Institutional and QIB Bidders shall be available for Allotment to Retail Individual Bidders who have Bid in the Issue at a price that is equal to or greater than the Issue Price. If the aggregate demand in this category is less than or equal to 9,56,400 Equity Shares at or above the Issue Price, full Allotment shall be made to the Retail Individual Bidders to the extent of their valid Bids.

If the aggregate demand in this category is greater than 9,56,400 Equity Shares at or above the Issue Price, the Allotment shall be made on a proportionate basis up to a minimum of 9,56,400 Equity Shares and in multiples of 1200 Equity Shares thereafter. For the method of proportionate Basis of Allotment, refer below.

b. For Non-Institutional Bidders

Bids received from Non-Institutional Bidders at or above the Issue Price shall be grouped together to determine the total demand under this category. The Allotment to all successful Non- Institutional Bidders will be made at the Issue Price.

The Issue size less Allotment to QIBs and Retail shall be available for Allotment to Non- Institutional Bidders who have Bid in the Issue at a price that is equal to or greater than the Issue Price. If the aggregate demand in this category is less than or equal to 4,10,400 Equity Shares at or above the Issue Price, full Allotment shall be made to Non-Institutional Bidders to the extent of their demand.

In case the aggregate demand in this category is greater than 4,10,400 Equity Shares at or above the Issue Price, Allotment shall be made on a proportionate basis up to a minimum of 4,10,400 Equity Shares and in multiples of 1200 Equity Shares thereafter. For the method of proportionate Basis of Allotment refer below.

c. For QIBs

Not more than 50% of the Net Issue shall be allocated on a proportionate basis to QIBs, provided that our Company may, in consultation with the Book Running Lead Manager, allocate up to 60% of the QIB Portion to Anchor Investors on a discretionary basis in accordance with the SEBI ICDR Regulations, of which one-third shall be reserved for domestic Mutual Funds, subject to valid Bids being received from domestic Mutual Funds at or above the Anchor Investor Allocation Price.

In the event of under-subscription, or non-allotment in the Anchor Investor Portion, the balance Equity Shares shall be added to the Net QIB Portion. Further, 5% of the Net QIB Portion shall be available for allocation on a proportionate basis only to Mutual Funds, and the remainder of the Net QIB Portion shall be available for allocation on a proportionate basis to all QIBs (other than Anchor Investors), including Mutual Funds, subject to valid Bids being received at or above the Offer Price.

Bids received from QIBs Bidding in the QIB Category (net of Anchor Portion) at or above the Issue Price may be grouped together to determine the total demand under this category. The QIB Category may be available for Allotment to QIBs who have Bid at a price that is equal to or greater than the Issue Price. Allotment may be undertaken in the following manner:

Allotment shall be undertaken in the following manner:

- a) In the first instance allocation to Mutual Funds for 5% of the Net QIB Portion shall be determined as follows:
 - In the event that Bids by Mutual Fund exceeds 5% of the Net QIB Portion, allocation to Mutual Funds shall be done on a proportionate basis for 5% of the QIB Portion.
 - In the event that the aggregate demand from Mutual Funds is less than 5% of the Net QIB Portion then all Mutual Funds shall get full Allotment to the extent of valid Bids received above the Issue Price.
 - Equity Shares remaining unsubscribed, if any, not allocated to Mutual Funds shall be available for Allotment to all QIB Bidders (other than Anchor Investors), including Mutual Funds, subject to valid Bids being received at or above the Issue Price;

Issuance of Allotment Advice

- 1) Upon approval of the Basis of Allotment by the Designated Stock Exchange.
- 2) On the basis of approved Basis of Allotment, the Issuer shall pass necessary corporate action to facilitate the allotment and credit of equity shares. Bidders are advised to instruct their Depository Participants to accept the Equity Shares that may be allotted to them pursuant to the issue.

The Book Running Lead Manager or the Registrar to the Issue will dispatch an Allotment Advice to their Bidders who have been allocated Equity Shares in the Issue. The dispatch of Allotment Advice shall be deemed a valid, binding and irrevocable contract for the Allotment to such Bidder.

- 3) Issuer will make the allotment of the Equity Shares and initiate corporate action for credit of shares to the successful Bidders Depository Account within 4 working days of the Issue Closing date. The Issuer also ensures the credit of shares to the successful Bidders Depository Account is completed within one working Day from the date of allotment, after the funds are transferred from ASBA Public Issue Account to Public Issue account of the issuer.

Designated Date:

On the Designated date, the SCSBs shall transfers the funds represented by allocations of the Equity Shares into Public Issue Account with the Bankers to the Issue.

The Company will issue and dispatch letters of allotment/ or letters of regret along with refund order or credit the allotted securities to the respective beneficiary accounts, if any within a period of 4 working days of the Bid/Issue Closing Date. The Company will intimate the details of allotment of securities to Depository immediately on allotment of securities under relevant provisions of the Companies Act, 2013 or other applicable provisions, if any

Disposal of Application and Application Moneys and Interest in Case of Delay

The Company shall ensure the dispatch of Allotment advice, and give benefit to the beneficiary account with Depository Participants and submit the documents pertaining to the Allotment to the Stock Exchange within 2 (two) working days of date of Allotment of Equity Shares.

The Company shall use best efforts to ensure that all steps for completion of the necessary formalities for listing and commencement of trading at NSE Emerge where the Equity Shares are proposed to be listed are taken within 3 (three) working days from Issue Closing Date.

In accordance with the Companies Act, the requirements of the Stock Exchange and the SEBI Regulations, the Company further undertakes that:

1. Allotment and Listing of Equity Shares shall be made within 3 (three) days of the Issue Closing Date;
2. Giving of Instructions for refund by unblocking of amount via ASBA not later than 2(two) working days of the Issue Closing Date, would be ensured; and

3. If such money is not repaid within prescribed time from the date our Company becomes liable to repay it, then our Company and every officer in default shall, on and from expiry of prescribed time, be liable to repay such application money, with interest as prescribed under SEBI (ICDR) Regulations, the Companies Act, 2013 and applicable law. Further, in accordance with Section 40 of the Companies Act, 2013, the Company and each officer in default may be punishable with fine and/or imprisonment in such a case.

Right to Reject Applications

In case of QIB Bidders, the Company in consultation with the Book Running Lead Manager may reject Applications provided that the reasons for rejecting the same shall be provided to such Bidder in writing. In case of Non-Institutional Bidders, Retail Individual Bidders who applied, the Company has a right to reject Applications based on technical grounds.

Impersonation

Attention of the Bidders is specifically drawn to the provisions of sub-section (1) of Section 38 of the Companies Act, 2013 which is reproduced below:

“Any person who-

- (a) Makes or abets making of an application in a fictitious name to a company for acquiring, or subscribing for, its securities; or
- (b) Makes or abets making of multiple applications to a company in different names or in different combinations of his name or surname for acquiring or subscribing for its securities; or
- (c) Otherwise induces directly or indirectly a company to allot, or register any transfer of, securities to him, or to any other person in a fictitious name, shall be liable for action under Section 447.”

Undertakings by Our Company

We undertake as follows:

1. That the complaints received in respect of the Issue shall be attended expeditiously and satisfactorily;
2. That all steps will be taken for the completion of the necessary formalities for listing and commencement of trading on Stock Exchange where the Equity Shares are proposed to be listed within three working days from Issue Closure date.
3. That the funds required for making refunds as per the modes disclosed or dispatch of allotment advice by registered post or speed post shall be made available to the Registrar and Share Transfer Agent to the Issue by our Company;
4. Where refunds (to the extent applicable) are made through electronic transfer of funds, a suitable communication shall be sent to the applicant within two Working Days from the Issue Closing Date, giving details of the bank where refunds shall be credited along with amount and expected date of electronic credit of refund;
5. That our Promoter ‘s contribution in full has already been brought in;
6. That no further Issue of Equity Shares shall be made till the Equity Shares Issued through the Prospectus are listed or until the Application monies are refunded on account of non-listing, undersubscription etc.;
7. That adequate arrangement shall be made to collect all Applications Supported by Blocked Amount while finalizing the Basis of Allotment;
8. If our Company does not proceed with the Issue after the Bid/Issue Opening Date but before allotment, then the reason thereof shall be given as a public notice to be issued by our Company within two days of the Bid/Issue Closing Date. The public notice shall be issued in the same newspapers where the Pre-Issue advertisements were published. The stock exchange on which the Equity Shares are proposed to be listed shall also be informed promptly;
9. If our Company withdraws the Issue after the Bid/Issue Closing Date, our Company shall be required to file a fresh Red Herring Prospectus with the Stock exchange/RoC/SEBI, in the event our Company subsequently decides to proceed with the Issue;

10. If allotment is not made within the prescribed time period under applicable law, the entire subscription amount received will be refunded/ unblocked within the time prescribed under applicable law. If there is delay beyond the prescribed time, our Company shall pay interest prescribed under the Companies Act, 2013, the SEBI Regulations and applicable law for the delayed period.

Utilization of Issue Proceeds

The Board of Directors of our Company certifies that:

- 1) All monies received out of the Issue shall be credited/ transferred to a separate bank account other than the bank account referred to in sub section (3) of Section 40 of the Companies Act 2013;
- 2) Details of all monies utilized out of the Issue referred above shall be disclosed and continue to be disclosed till the time any part of the issue proceeds remains unutilized, under an appropriate head in our balance sheet of our company indicating the purpose for which such monies have been utilized;
- 3) Details of all unutilized monies out of the Issue, if any shall be disclosed under the appropriate separate head in the balance sheet of our company indicating the form in which such unutilized monies have been invested and
- 4) Our Company shall comply with the requirements of SEBI Listing Regulations, 2015 in relation to the disclosure and monitoring of the utilization of the proceeds of the Issue.
- 5) Our Company shall not have recourse to the Issue Proceeds until the approval for listing and trading of the Equity Shares from the Stock Exchange where listing is sought has been received.
- 6) The Book Running Lead Manager undertakes that the complaints or comments received in respect of the Issue shall be attended by our Company expeditiously and satisfactorily.

Equity Shares in Dematerialized Form with NSDL or CDSL

To enable all shareholders of our Company to have their shareholding in electronic form, the Company has signed the following tripartite agreements with the Depositories and the Registrar and Share Transfer Agent:

- Tripartite Agreement dated March 07, 2024 between CDSL, the Company and the Registrar to the Issue;
- Tripartite Agreement dated March 11, 2024 between NSDL, the Company and the Registrar to the Issue;

The Company's equity shares bear an ISIN: INE0U2N01013.

RESTRICTIONS ON FOREIGN OWNERSHIP OF INDIAN SECURITIES

Foreign investment in Indian securities is regulated through the Industrial Policy, 1991 of the Government of India and Foreign Exchange Management Act, 1999 (“FEMA”). While the Industrial Policy, 1991 prescribes the limits and the conditions subject to which foreign investment can be made in different sectors of the Indian economy, FEMA regulates the precise manner in which such investment may be made. Under the Industrial Policy, unless specifically restricted, foreign investment is freely permitted in all sectors of Indian economy up to any extent and without any prior approvals, but the foreign investor is required to follow certain prescribed procedures for making such investment. The government bodies responsible for granting foreign investment approvals are the Reserve Bank of India (“RBI”) and Department of Industrial Policy and Promotion, Ministry of Commerce and Industry, Government of India (“DIPP”).

The Government of India has from time to time made policy pronouncements on FDI through press notes and press releases. The DPIIT issued the Consolidated Foreign Direct Investment Policy notified by the DPIIT File No. 5(2)/2020-FDI Policy dated October 15, 2020, with effect from October 15, 2020 (the “FDI Policy”), which consolidates and supersedes all previous press notes, press releases and clarifications on FDI issued by the DPIIT or the DPIIT that were in force and effect prior to October 15, 2020. The Government of India proposes to update the consolidated circular on FDI Policy once every year and therefore, the FDI Policy will be valid until the DPIIT issues an updated circular.

In terms of the FEMA NDI Rules, a person resident outside India may make investments into India, subject to certain terms and conditions, and provided that an entity of a country, which shares land border with India or the beneficial owner of an investment into India who is situated in or is a citizen of any such country, shall invest only with government approval.

The transfer of shares between an Indian resident and a non-resident does not require the prior approval of the RBI, provided that (i) the activities of the investee company are under the automatic route under the foreign direct investment policy and transfer does not attract the provisions of the Takeover Regulations; (ii) the non-resident shareholding is within the sectoral limits under the FDI policy; and (iii) the pricing is in accordance with the guidelines prescribed by the SEBI/ RBI.

Further, in accordance with Press Note No. 3 (2020 Series), dated April 17, 2020 issued by the DPIIT and the Foreign Exchange Management (Non-debt Instruments) Amendment Rules, 2020 which came into effect from April 22, 2020, any investment, subscription, purchase or sale of equity instruments by entities of a country which shares land border with India or where the beneficial owner of an investment into India is situated in or is a citizen of any such country (“Restricted Investors”), will require prior approval of the Government, as prescribed in the Consolidated FDI Policy and the FEMA Rules. Further, in the event of transfer of ownership of any existing or future foreign direct investment in an entity in India, directly or indirectly, resulting in the beneficial ownership falling within the aforesaid restriction/ purview, such subsequent change in the beneficial ownership will also require approval of the Government. Furthermore, on April 22, 2020, the Ministry of Finance, Government of India has also made a similar amendment to the FEMA Rules. Pursuant to the Foreign Exchange Management (Non-debt Instruments) (Fourth Amendment) Rules, 2020, a multilateral bank or fund, of which India is a member, shall not be treated as an entity of a particular country nor shall any country be treated as the beneficial owner of the investments of such bank of fund in India. Each Bidder should seek independent legal advice about its ability to participate in the Offer. In the event such prior approval of the Government of India is required, and such approval has been obtained, the Bidder shall intimate our Company and the Registrar to the Offer in writing about such approval along with a copy thereof within the Issue Period.

As per the existing policy of the Government of India, OCBs cannot participate in this Issue and in accordance with the extant FDI guidelines on sectoral caps, pricing guidelines etc. as amended by Reserve bank of India, from time to time. Investors are advised to confirm their eligibility under the relevant laws before investing and / or subsequent purchase or sale transaction in the Equity Shares of our Company. Investors will not offer, sell, pledge or transfer the Equity Shares of our Company to any person who is not eligible under applicable laws, rules, regulations, guidelines. Our Company, the Underwriters and their respective directors, officers, agents, affiliates and representatives, as applicable, accept no responsibility or liability for advising any investor on whether such investor is eligible to acquire Equity Shares of our Company.

Investment conditions/ restrictions for overseas entities

Under the current FDI Policy 2020, the maximum amount of Investment (sectoral cap) by foreign investor in an issuing entity is composite unless it is explicitly provided otherwise including all types of foreign investments, direct and indirect, regardless of whether it has been made for FDI, FPI, NRI/OCI, LLPs, FVCI, Investment Vehicles and DRs under Foreign Exchange Management. (Non-debt Instruments) Rules, 2019. Any equity holding by a person resident outside India resulting from conversion of any debt instrument under any arrangement shall be reckoned as foreign investment under the composite cap.

Portfolio Investment upto aggregate foreign investment level of 49% or sectoral/ statutory cap, whichever is lower, will not be subject to either Government approval or compliance of sectoral conditions, if such investment does not result in transfer of ownership and/or control of Indian entities from resident Indian citizens to non-resident entities. Other foreign investments will be subject to conditions of Government approval and compliance of sectoral conditions as per FDI Policy. The total foreign investment, direct and indirect, in the issuing entity will not exceed the sectoral/statutory cap.

Investment by FPIs under Portfolio Investment Scheme (PIS)

With regards to purchase/sale of capital instruments of an Indian company by an FPI under PIS the total holding by each FPI or an investor group as referred in SEBI (FPI) Regulations, 2014 shall not exceed 10% of the total paid-up equity capital on a fully diluted basis or less than 10% of the paid-up value of each series of debentures or preference shares or share warrants issued by an Indian company and the total holdings of all FPIs put together shall not exceed 24% of paid-up equity capital on fully diluted basis or paid-up value of each series of debentures or preference shares or share warrants. The said limit of 10% and 24% will be called the individual and aggregate limit, respectively. However, this limit of 24 % may be increased up to sectoral cap/statutory ceiling, as applicable, by the Indian company concerned by passing a resolution by its Board of Directors followed by passing of a special resolution to that effect by its general body.

Investment by NRI or OCI on repatriation basis

The purchase/ sale of equity shares, debentures, preference shares and share warrants issued by an Indian company (hereinafter referred to as “Capital Instruments”) of a listed Indian company on a recognised stock exchange in India by Non-Resident Indian (NRI) or Overseas Citizen of India (OCI) on repatriation basis is allowed subject to certain conditions under Foreign Exchange Management (Non-debt Instruments) Rules, 2019.

The total holding by any individual NRI or OCI shall not exceed 5% of the total paid-up equity capital on a fully diluted basis or should not exceed 5% of the paid-up value of each series of debentures or preference shares or share warrants issued by an Indian company and the total holdings of all NRIs and OCIs put together shall not exceed 10% of the total paid-up equity capital on a fully diluted basis or shall not exceed 10% of the paid-up value of each series of debentures or preference shares or share warrants; provided that the aggregate ceiling of 10% may be raised to 24% if a special resolution to that effect is passed by the general body of the Indian company.

Investment by NRI or OCI on non-repatriation basis

As per current FDI Policy 2020, Foreign Exchange Management (Non-debt Instruments) Rules, 2019, Purchase/ sale of Capital Instruments or convertible notes or units or contribution to the capital of an LLP by a NRI or OCI on non- repatriation basis – will be deemed to be domestic investment at par with the investment made by residents. This is further subject to remittance channel restrictions.

The Equity Shares have not been and will not be registered under the U.S. Securities Act of 1933, as amended (“US Securities Act”) or any other state securities laws in the United States of America and may not be sold or offered within the United States of America, or to, or for the account or benefit of “US Persons” as defined in Regulation S of the U.S. Securities Act, except pursuant to exemption from, or in a transaction not subject to, the registration requirements of US Securities Act and applicable state securities laws.

Accordingly, the equity shares are being offered and sold only outside the United States of America in an offshore transaction in reliance upon Regulation S under the US Securities Act and the applicable laws of the jurisdiction where those offers and sale occur.

Further, no offer to the public (as defined under Directive 20003/71/EC, together with any amendments) and implementing measures thereto, (the “Prospectus Directive”) has been or will be made in respect of the Issue in any member State of the European Economic Area which has implemented the Prospectus Directive except for any such offer made under exemptions available under the Prospectus Directive, provided that no such offer shall result in a requirement to publish or supplement a prospectus pursuant to the Prospectus Directive, in respect of the Issue.

Any forwarding, distribution or reproduction of this document in whole or in part may be unauthorized. Failure to comply with this directive may result in a violation of the Securities Act or the applicable laws of other jurisdictions. Any investment decision should be made on the basis of the final terms and conditions and the information contained in this Prospectus.

The Equity Shares have not been and will not be registered, listed or otherwise qualified in any other jurisdiction outside India and

may not be offered or sold, and Application may not be made by persons in any such jurisdiction, except in compliance with the applicable laws of such jurisdiction.

The above information is given for the benefit of the Applicants. Our Company and the Book Running Lead Manager are not liable for any amendments or modification or changes in applicable laws or regulations, which may occur after the date of this Prospectus. Applicants are advised to make their independent investigations and ensure that the Applications are not in violation of laws or regulations applicable to them and do not exceed the applicable limits under the laws and regulations.

SECTION IX - MAIN PROVISIONS OF THE ARTICLES OF ASSOCIATION OF OUR COMPANY

Pursuant to Schedule I of the Companies Act, and the SEBI (ICDR) Regulations, the Main provisions of the Articles of Association relating to voting rights, dividend, lien, forfeiture, restrictions on transfer and Transmission of equity shares or debentures, their consolidation or splitting are as provided below. Each provision below is numbered as per the corresponding article number in the articles of association and defined terms herein have the meaning given to them in the Articles of Association.

The following regulations comprised in the Articles of Association were adopted pursuant to the member's special resolution passed at the Extra Ordinary General Meeting held on February 10, 2024. In substitution for, and to the entire exclusion of, the earlier regulation comprised in the extant Articles of Association of the Company.

INTERPRETATION

- I
1. In these regulations-
 - b. "the Act" means the Companies Act, 2013,
 - c. "the seal" means the common seal of the company.
 2. Unless the context otherwise requires, words or expressions contained in these regulations shall bear the same meaning as in the Act or any statutory modification thereof in force at the date at which these regulations become binding on the company.

SHARE CAPITAL AND VARIATION OF RIGHTS

- II. 1
- i. Subject to the provisions of the Act and these Articles, the shares in the capital of the company shall be under the control of the Directors who may issue, allot or otherwise dispose of the same or any of them to such persons, in such proportion and on such terms and conditions and either at a premium or at par and at such time as they may from time to time think fit.
 - ii. The Board shall also be entitled to issue, from time to time, subject to any other legislation for the time being in force, any other securities, including securities convertible into shares, exchangeable into shares, or carrying a warrant, with or without any attached securities, carrying such terms as to coupon, returns, repayment, servicing, as may be decided by the terms of such issue.
- 2.
- i. Every person whose name is entered as a member in the register of members shall be entitled to receive within two months after incorporation, in case of subscribers to the memorandum or after allotment or within one month after the application for the registration of transfer or transmission or within such other period as the conditions of issue shall be provided, -
 - a. one certificate for all his shares without payment of any charges; or
 - b. several certificates, each for one or more of his shares, upon payment of twenty rupees for each certificate after the first.
 - ii. Every certificate shall be under the seal and shall specify the shares to which it relates and the amount paid - up thereon
 - iii. In respect of any share or shares held jointly by several persons, the company shall not be bound to issue more than one certificate, and delivery of a certificate for a share to one of several joint holders shall be sufficient delivery to all such holders.
- 3.
- i. If any share certificate be worn out, defaced, mutilated or torn or if there be no further space on the back for endorsement of transfer, then upon production and surrender thereof to the company, a new certificate may be issued in lieu thereof, and if any certificate is lost or destroyed then upon proof thereof to the satisfaction of the company and on execution of such indemnity as the company deem adequate, a new certificate in lieu thereof shall be given. Every certificate under this Article shall be issued on payment of twenty rupees for each certificate.
 - ii. The provisions of Articles (2) and (3) shall mutatis mutandis apply to debentures of the company.

4. Except as required by law, no person shall be recognised by the company as holding any share upon any trust, and the company shall not be bound by, or be compelled in any way to recognise (even when having notice thereof) any equitable, contingent, future or partial interest in any share, or any interest in any fractional part of a share, or (except only as by these regulations or by law otherwise provided) any other rights in respect of any share except an absolute right to the entirety thereof in the registered holder.
5.
 - i. The company may exercise the powers of paying commissions conferred by sub-section (6) of section 40, provided that the rate per cent or the amount of the commission paid or agreed to be paid shall be disclosed in the manner required by that section and rules made thereunder.
 - ii. The rate or amount of the commission shall not exceed the rate or amount prescribed in rules made under sub-section (6) of section 40.
 - iii. The commission may be satisfied by the payment of cash or the allotment of fully or partly paid shares or partly in the one way and partly in the other.
6.
 - i. If at any time the share capital is divided into different classes of shares, the rights attached to any class (unless otherwise provided by the terms of issue of the shares of that class) may, subject to the provisions of section 48, and whether or not the company is being wound up, be varied with the consent in writing of the holders of three-fourths of the issued shares of that class, or with the sanction of a special resolution passed at a separate meeting of the holders of the shares of that class.
 - ii. To every such separate meeting, the provisions of these regulations relating to general meetings shall mutatis mutandis apply, but so that the necessary quorum shall be at least two persons holding at least one-third of the issued shares of the class in question.
7. The rights conferred upon the holders of the shares of any class issued with preferred or other rights shall not, unless otherwise expressly provided by the terms of issue of the shares of that class, be deemed to be varied by the creation or issue of further shares ranking pari-passu therewith.
8. Subject to the provisions of section 55, any preference shares may, with the sanction of an ordinary resolution, be issued on the terms that they are to be redeemed on such terms and in such manner as the company before the issue of the shares may, by special resolution, determine.

LIEN

9.
 - i. The company shall have a first and paramount lien
 - a. on every share (not being a fully paid share), for all monies (whether presently payable or not) called, or payable at a fixed time, in respect of that share; and
 - b. on all shares (not being fully paid shares) standing registered in the name of a single person, for all monies presently payable by him or his estate to the company:
Provided that the Board of directors may at any time declare any share to be wholly or in part exempt from the provisions of this clause.
 - ii. The company's lien, if any, on a share shall extend to all dividends payable and bonuses declared from time to time in respect of such shares.
 - iii. That fully paid shares shall be free from all lien and that in the case of partly paid shares the Issuer's lien shall be restricted to moneys called or payable at a fixed time in respect of such shares.
10. The company may sell, in such manner as the Board thinks fit, any shares on which the company has a lien: Provided that no sale shall be made-
 - a. unless a sum in respect of which the lien exists is presently payable; or
 - b. until the expiration of fourteen days after a notice in writing stating and demanding payment of such part of the amount in respect of which the lien exists as is presently payable, has been given to the registered holder for the time being of the share or the person entitled thereto by reason of his death or insolvency.

11.
 - i. To give effect to any such sale, the Board may authorise some person to transfer the shares sold to the purchaser thereof
 - ii. The purchaser shall be registered as the holder of the shares comprised in any such transfer.
 - iii. The purchaser shall not be bound to see to the application of the purchase money, nor shall his title to the shares be affected by any irregularity or invalidity in the proceedings in reference to the sale.
12.
 - i. The proceeds of the sale shall be received by the company and applied in payment of such part of the amount in respect of which the lien exists as is presently payable.
 - ii. The residue, if any, shall, subject to a like lien for sums not presently payable as existed upon the shares before the sale, be paid to the person entitled to the shares at the date of the sale.

CALLS ON SHARES

13.
 - i. The Board may, from time to time, make calls upon the members in respect of any monies unpaid on their shares (whether on account of the nominal value of the shares or by way of premium) and not by the conditions of allotment thereof made payable at fixed times:

Provided that no call shall exceed one-fourth of the nominal value of the share or be payable at less than one month from the date fixed for the payment of the last preceding call.
 - ii. Each member shall, subject to receiving at least fourteen days' notice specifying the time or times and place of payment, pay to the company, at the time or times and place so specified, the amount called on his shares.
 - iii. A call may be revoked or postponed at the discretion of the Board.
 - iv. That any amount paid up in advance of calls on any share may carry interest but shall not in respect thereof confer a right to dividend or to participate in profits
14. A call shall be deemed to have been made at the time when the resolution of the Board authorizing the call was passed and may be required to be paid by installments.
15. The joint holders of a share shall be jointly and severally liable to pay all calls in respect thereof.
16. If a sum called in respect of a share is not paid before or on the day appointed for payment thereof, the person from whom the sum is due shall pay interest thereon from the day appointed for payment thereof to the time of actual payment at ten per cent per annum or at such lower rate, if any, as the Board may determine.

The Board shall be at liberty to waive payment of any such interest wholly or in part.

17.
 - i. Any sum which by the terms of issue of a share becomes payable on allotment or at any fixed date, whether on account of the nominal value of the share or by way of premium, shall, for the purposes of these regulations, be deemed to be a call duly made and payable on the date on which by the terms of issue such sum becomes payable.
 - ii. In case of non-payment of such sum, all the relevant provisions of these regulations as to payment of interest and expenses, forfeiture or otherwise shall apply as if such sum had become payable by virtue of a call duly made and notified.
18. The Board -
 - a. may, if it thinks fit, receive from any member willing to advance the same, all or any part of the monies uncalled and unpaid upon any shares held by him and
 - b. upon all or any of the monies so advanced, may (until the same would, but for such advance, become presently payable) pay interest at such rate not exceeding, unless the company in general meeting shall otherwise direct, twelve per cent per annum, as may be agreed upon between the Board and the member paying the sum in advance.

TRANSFER OF SHARES

19.
 - i. The instrument of transfer of any share in the company shall be executed by or on behalf of both the transferor and transferee.
 - ii. The transferor shall be deemed to remain a holder of the share until the name of the transferee is entered in the register of members in respect thereof.
 - iii. That a common form of transfer shall be used
20.
 - i. The Board may, subject to the right of appeal conferred by section 58 decline to register—
 - ii. the transfer of a share, not being a fully paid share, to a person of whom they do not approve; or
 - iii. any transfer of shares on which the company has a lien.
21. The Board may decline to recognise any instrument of transfer unless—
 - a. the instrument of transfer is in the form as prescribed in rules made under sub-section (1) of section 56;
 - b. the instrument of transfer is accompanied by the certificate of the shares to which it relates, and such other evidence as the Board may reasonably require to show the right of the transferor to make the transfer; and
 - c. the instrument of transfer is in respect of only one class of shares.

That registration of transfer shall not be refused on the ground of the transferor being either alone or jointly with any other person or persons indebted to the Issuer on any account whatsoever

22. On giving not less than seven days' previous notice in accordance with section 91 and rules made thereunder, the registration of transfers may be suspended at such times and for such periods as the Board may from time to time determine:
Provided that such registration shall not be suspended for more than thirty days at any one time or for more than forty-five days in the aggregate in any year.

TRANSMISSION OF SHARES

23.
 - i. On the death of a member, the survivor or survivors where the member was a joint holder, and his nominee or nominees or legal representatives where he was a sole holder, shall be the only persons recognised by the company as having any title to his interest in the shares
 - ii. Nothing in clause (i) shall release the estate of a deceased joint holder from any liability in respect of any share which had been jointly held by him with other persons.
 - iii. That a common form of transmission shall be used
24.
 - i. Any person becoming entitled to a share in consequence of the death or insolvency of a member may, upon such evidence being produced as may from time to time properly be required by the Board and subject as hereinafter provided, elect, either-
 - a. to be registered himself as holder of the share; or
 - b. to make such transfer of the share as the deceased or insolvent member could have made.
 - ii. The Board shall, in either case, have the same right to decline or suspend registration as it would have had, if the deceased or insolvent member had transferred the share before his death or insolvency.
25.
 - i. If the person so becoming entitled shall elect to be registered as holder of the share himself, he shall deliver or send to the company a notice in writing signed by him stating that he so elects.
 - ii. If the person aforesaid shall elect to transfer the share, he shall testify his election by executing a transfer of the share.

iii. All the limitations, restrictions and provisions of these regulations relating to the right to transfer and the registration of transfers of shares shall be applicable to any such notice or transfer as aforesaid as if the death or insolvency of the member had not occurred and the notice or transfer were a transfer signed by that member.

26. A person becoming entitled to a share by reason of the death or insolvency of the holder shall be entitled to the same dividends and other advantages to which he would be entitled if he were the registered holder of the share, except that he shall not, before being registered as a member in respect of the share, be entitled in respect of it to exercise any right conferred by membership in relation to meetings of the company:

Provided that the Board may, at any time, give notice requiring any such person to elect either to be registered himself or to transfer the share, and if the notice is not complied with within ninety days, the Board may thereafter withhold payment of all dividends, bonuses or other monies payable in respect of the share, until the requirements of the notice have been complied with.

FORFEITURE OF SHARES

27. If a member fails to pay any call, or installment of a call, on the day appointed for payment thereof, the Board may, at any time thereafter during such time as any part of the call or installment remains unpaid, serve a notice on him requiring payment of so much of the call or installment as is unpaid, together with any interest which may have accrued.

28. The notice aforesaid shall-

- a. name a further day (not being earlier than the expiry of fourteen days from the date of service of the notice) on or before which the payment required by the notice is to be made; and
- b. state that, in the event of non-payment on or before the day so named, the shares in respect of which the call was made shall be liable to be forfeited.

29. If the requirements of any such notice as aforesaid are not complied with, any share in respect of which the notice has been given may, at any time thereafter, before the payment required by the notice has been made, be forfeited by a resolution of the Board to that effect.

30. i. A forfeited share may be sold or otherwise disposed of on such terms and in such manner as the Board thinks fit.

ii. At any time before a sale or disposal as aforesaid, the Board may cancel the forfeiture on such terms as it thinks fit.

31. i. A person whose shares have been forfeited shall cease to be a member in respect of the forfeited shares, but shall, notwithstanding the forfeiture, remain liable to pay to the company all monies which, at the date of forfeiture, were presently payable by him to the company in respect of the shares.

ii. The liability of such person shall cease if and when the company shall have received payment in full of all such monies in respect of the shares.

32. i. A duly verified declaration in writing that the declarant is a director, the manager or the secretary, of the company, and that a share in the company has been duly forfeited on a date stated in the declaration, shall be conclusive evidence of the facts therein stated as against all persons claiming to be entitled to the share;

ii. The company may receive the consideration, if any, given for the share on any sale or disposal thereof and may execute a transfer of the share in favour of the person to whom the share is sold or disposed of;

iii. The transferee shall thereupon be registered as the holder of the share; and

iv. The transferee shall not be bound to see to the application of the purchase money, if any, nor shall his title to the share be affected by any irregularity or invalidity in the proceedings in reference to the forfeiture, sale or disposal of the share.

33. The provisions of these regulations as to forfeiture shall apply in the case of non-payment of any sum which, by the terms of issue of a share, becomes payable at a fixed time, whether on account of the nominal value of the share or by way of premium, as if the same had been payable by virtue of a call duly made and notified.

ALTERATION OF CAPITAL

34. The company may, from time to time, by ordinary resolution increase the share capital by such sum, to be divided into shares of such amount, as may be specified in the resolution.
35. Subject to the provisions of section 61, the company may, by ordinary resolution-
- i. consolidate and divide all or any of its share capital into shares of larger amount than its existing shares;
 - ii. convert all or any of its fully paid-up shares into stock, and reconvert that stock into fully paid-up shares of any denomination;
 - iii. sub-divide its existing shares or any of them into shares of smaller amount than is fixed by the memorandum; and
 - iv. cancel any shares which, at the date of the passing of the resolution, have not been taken or agreed to be taken by any person.
 - v. Permission for sub-division/ consolidation of share certificates
36. Where shares are converted into stock, —
- the holders of stock may transfer the same or any part thereof in the same manner as, and subject to the same regulations under which, the shares from which the stock arose might before the conversion have been transferred, or as near thereto as circumstances admit:
 - Provided that the Board may, from time to time, fix the minimum amount of stock transferable, so, however, that such minimum shall not exceed the nominal amount of the shares from which the stock arose.
 - the holders of stock shall, according to the amount of stock held by them, have the same rights, privileges and advantages as regards dividends, voting at meetings of the company, and other matters, as if they held the shares from which the stock arose; but no such privilege or advantage (except participation in the dividends and profits of the company and in the assets on winding up) shall be conferred by an amount of stock which would not, if existing in shares, have conferred that privilege or advantage.
 - such of the regulations of the company as are applicable to paid-up shares shall apply to stock and the words “share” and “shareholder” in those regulations shall include “stock” and “stock-holder” respectively.
37. The company may, by special resolution, reduce in any manner and with, and subject to, any incident authorised and consent required by law-
- it share capital;
 - any capital redemption reserve account; or
 - any share premium account.

CAPITALISATION OF PROFITS

38. The company in general meeting may, upon the recommendation of the Board, resolve-
- i. that it is desirable to capitalise any part of the amount for the time being standing to the credit of any of the company’s reserve accounts, or to the credit of the, profit and loss account, or otherwise available for distribution; and
 - ii. that such sum be accordingly set free for distribution in the manner specified in clause (ii) amongst the members who would have been entitled thereto, if distributed by way of dividend and in the same proportions.
 - iii. The sum aforesaid shall not be paid in cash but shall be applied, subject to the provision contained in clause (iii), either in or towards-

- a. paying up any amounts for the time being unpaid on any shares held by such members respectively;
 - b. paying up in full, unissued shares of the company to be allotted and distributed, credited as fully paid-up, to and amongst such members in the proportions aforesaid;
 - c. partly in the way specified in sub-clause (A) and partly in that specified in sub-clause (B);
- iv. A securities premium account and a capital redemption reserve account may, for the purposes of this regulation, be applied in the paying up of unissued shares to be issued to members of the company as fully paid bonus shares;
 - v. The Board shall give effect to the resolution passed by the company in pursuance of this regulation.
- 39.
- i. Whenever such a resolution as aforesaid shall have been passed, the Board shall-
 - a. make all appropriations and applications of the undivided profits resolved to be capitalised thereby, and all
 - b. allotments and issues of fully paid shares if any; and
 - c. generally do all acts and things required to give effect thereto.
 - ii. The Board shall have power-
 - a. to make such provisions, by the issue of fractional certificates or by payment in cash or otherwise as it thinks fit, for the case of shares becoming distributable in fractions; and
 - b. to authorise any person to enter, on behalf of all the members entitled thereto, into an agreement with the company providing for the allotment to them respectively, credited as fully paid-up, of any further shares to which they may be entitled upon such capitalisation, or as the case may require, for the payment by the company on their behalf, by the application thereto of their respective proportions of profits resolved to be capitalised, of the amount or any part of the amounts remaining unpaid on their existing shares;
 - iii. Any agreement made under such authority shall be effective and binding on such members

BUY-BACK OF SHARES

40. Notwithstanding anything contained in these articles but subject to the provisions of sections 68 to 70 and any other applicable provision of the Act or any other law for the time being in force, the company may purchase its own shares or other specified securities.

GENERAL MEETINGS

41. All general meetings other than annual general meeting shall be called extraordinary general meeting.
- 42.
- i. The Board may, whenever it thinks fit, call an extraordinary general meeting.
 - ii. If at any time directors capable of acting who are sufficient in number to form a quorum are not within India, any director or any two members of the company may call an extraordinary general meeting in the same manner, as nearly as possible, as that in which such a meeting may be called by the Board.

PROCEEDINGS AT GENERAL MEETINGS

- 43.
- i. No business shall be transacted at any general meeting unless a quorum of members is present at the time when the meeting proceeds to business.
 - ii. Save as otherwise provided herein, the quorum for the general meetings shall be as provided in section 103.
44. The chairperson, if any, of the Board shall preside as Chairperson at every general meeting of the company.
45. If there is no such Chairperson, or if he is not present within fifteen minutes after the time appointed for holding the meeting or is unwilling to act as chairperson of the meeting, the directors present shall elect one of their members to be Chairperson of the meeting.

46. If at any meeting no director is willing to act as Chairperson or if no director is present within fifteen minutes after the time appointed for holding the meeting, the members present shall choose one of their members to be Chairperson of the meeting.

ADJOURNMENT OF MEETING

47. i. The Chairperson may, with the consent of any meeting at which a quorum is present, and shall, if so directed by the meeting, adjourn the meeting from time to time and from place to place.
- ii. No business shall be transacted at any adjourned meeting other than the business left unfinished at the meeting from which the adjournment took place.
- iii. When a meeting is adjourned for thirty days or more, notice of the adjourned meeting shall be given as in the case of an original meeting.
- iv. Save as aforesaid, and as provided in section 103 of the Act, it shall not be necessary to give any notice of an adjournment or of the business to be transacted at an adjourned meeting.

VOTING RIGHTS

48. Subject to any rights or restrictions for the time being attached to any class or classes of shares,
- i. on a show of hands, every member present in person shall have one vote;
- ii. and on a poll, the voting rights of members shall be in proportion to his share in the paid-up equity share capital of the company.
- iii. That option or right to call of shares shall not be given to any person except with the sanction of the Issuer in general meetings
49. A member may exercise his vote at a meeting by electronic means in accordance with section 108 and shall vote only once.
50. i. In the case of joint holders, the vote of the senior who tenders a vote, whether in person or by proxy, shall be accepted to the exclusion of the votes of the other joint holders.
- ii. For this purpose, seniority shall be determined by the order in which the names stand in the register of members.
51. A member of unsound mind, or in respect of whom an order has been made by any court having jurisdiction in lunacy, may vote, whether on a show of hands or on a poll, by his committee or other legal guardian, and any such committee or guardian may, on a poll, vote by proxy.
52. Any business other than that upon which a poll has been demanded maybe proceeded with, pending the taking of the poll.
53. No member shall be entitled to vote at any general meeting unless all calls or other sums presently payable by him in respect of shares in the company have been paid
54. i. No objection shall be raised to the qualification of any voter except at the meeting or adjourned meeting at which the vote objected to is given or tendered, and every vote not disallowed at such meeting shall be valid for all purposes.
- ii. Any such objection made in due time shall be referred to the Chairperson of the meeting, whose decision shall be final and conclusive.

PROXY

55. The instrument appointing a proxy and the power-of-attorney or other authority, if any, under which it is signed or a notarised copy of that power or authority, shall be deposited at the registered office of the company not less than 48 hours before the time for holding the meeting or adjourned meeting at which the person named in the instrument proposes to vote, or, in the case of a poll, not less than 24 hours before the time appointed for the taking of the poll; and in default the instrument of proxy shall not be treated as valid.
56. An instrument appointing a proxy shall be in the form as prescribed in the rules made under section 105
57. A vote given in accordance with the terms of an instrument of proxy shall be valid, notwithstanding the previous death or insanity of the principal or the revocation of the proxy or of the authority under which the proxy was executed, or the transfer of the shares in respect of which the proxy is given:

Provided that no intimation in writing of such death, insanity, revocation or transfer shall have been received by the company at its office before the commencement of the meeting or adjourned meeting at which the proxy is used.

BOARD OF DIRECTORS

58. The number of the directors and the names of the first directors shall be determined in writing by the subscribers of the memorandum or a majority of them. The following are the First Directors of the Company:
1. Nitin Kumar Heda
 2. Prahladrai Ramdayal Heda
 3. Khushboo Manishkumar Heda

59. The remuneration of the directors shall, in so far as it consists of a monthly payment, be deemed to accrue from day-to-day.

In addition to the remuneration payable to them in pursuance of the Act, the directors may be paid all travelling, hotel and other expenses properly incurred by them-

- in attending and returning from meetings of the Board of Directors or any committee thereof or general meetings of the company; or
- in connection with the business of the company.

60. The Board may pay all expenses incurred in getting up and registering the company.
61. The company may exercise the powers conferred on it by section 88 with regard to the keeping of a foreign register; and the Board may (subject to the provisions of that section) make and vary such regulations as it may think fit respecting the keeping of any such register.
62. i. All cheques, promissory notes, drafts, hundis, bills of exchange and other negotiable instruments, and all receipts for monies paid to the company, shall be signed, drawn, accepted, endorsed, or otherwise executed, as the case may be, by such person and in such manner as the Board shall from time to time by resolution determine.
- ii. The Board or duly constitute committee thereto have power to borrow from time to time such sums of money for the purpose of the Company upon such terms as may be expedient and with or without security.
63. Every director present at any meeting of the Board or of a committee thereof shall sign his name in a book to be kept for that purpose.
64. i. Subject to the provisions of section 149, the Board shall have power at any time, and from time to time, to appoint a person as an additional director, provided the number of the directors and additional directors together shall not at any time exceed the maximum strength fixed for the Board by the articles.
- ii. Such person shall hold office only up to the date of the next annual general meeting of the company but shall be eligible for appointment by the company as a director at that meeting subject to the provisions of the Act.

PROCEEDINGS OF THE BOARD

65. The Board of Directors may meet for the conduct of business, adjourn and otherwise regulate its meetings, as it thinks fit.
- A director may, and the manager or secretary on the requisition of a director shall, at any time, summon a meeting of the Board.
66. i. Save as otherwise expressly provided in the Act, questions arising at any meeting of the Board shall be decided by a majority of votes.
- ii. In case of an equality of votes, the Chairperson of the Board, if any, shall have a second or casting vote.
67. The continuing directors may act notwithstanding any vacancy in the Board; but, if and so long as their number is reduced below the quorum fixed by the Act for a meeting of the Board, the continuing directors or director may act for the purpose of increasing the number of directors to that fixed for the quorum, or of summoning a general meeting of the company, but for no other purpose.
68. i. The Board may elect a chairperson of its meetings and determine the period for which he is to hold office.
- ii. If no such Chairperson is elected, or if at any meeting the Chairperson is not present within five minutes after the time appointed for holding the meeting, the directors present may choose one of their number to be Chairperson of the meeting.
69. i. The Board may, subject to the provisions of the Act, delegate any of its powers to committees consisting of such member or members of its body as it thinks fit.
- ii. Any committee so formed shall, in the exercise of the powers so delegated, conform to any regulations that may be imposed on it by the Board.
70. i. A committee may elect a chairperson of its meetings.
- ii. If no such Chairperson is elected, or if at any meeting the 72 Chairperson is not present within five minutes after the time appointed for holding the meeting, the members present may choose one of their members to be Chairperson of the meeting.
71. i. A committee may meet and adjourn as it thinks fit.
- ii. Questions arising at any meeting of a committee shall be determined by a majority of votes of the members present, and in case of an equality of votes, the Chairperson shall have a second or casting vote.
72. All acts done in any meeting of the Board or of a committee thereof or by any person acting as a director, shall, notwithstanding that it may be afterwards discovered that there was some defect in the appointment of any one or more of such directors or of any person acting as aforesaid, or that they or any of them were disqualified, be as valid as if every such director or such person had been duly appointed and was qualified to be a director.
73. Save as otherwise expressly provided in the Act, a resolution in writing, signed by all the members of the Board or of a committee thereof, for the time being entitled to receive notice of a meeting of the Board or committee, shall be valid and effective as if it had been passed at a meeting of the Board or committee, duly convened and held.

CHIEF EXECUTIVE OFFICER, MANAGER, COMPANY SECRETARY OR CHIEF FINANCIAL OFFICER

74. Subject to the provisions of the Act,
- i. A chief executive officer, manager, company secretary or chief financial officer may be appointed by the Board for such term, at such remuneration and upon such conditions as it may think fit; and any chief executive officer, manager, company secretary or chief financial officer so appointed may be removed by means of a resolution of the Board;
- ii. A director may be appointed as chief executive officer, manager, company secretary or chief financial officer

75. A provision of the Act or these regulations requiring or authorising a thing to be done by or to a director and chief executive officer, manager, company secretary or chief financial officer shall not be satisfied by its being done by or to the same person acting both as director and as, or in place of, chief executive officer, manager, company secretary or chief financial officer.

THE SEAL

76. i. The Board shall provide for the safe custody of the seal.
- ii. The seal of the company shall not be affixed to any instrument except by the authority of a resolution of the Board or of a committee of the Board authorised by it in that behalf, and except in the presence of at least two directors and of the secretary or such other person as the Board may appoint for the purpose; and those two directors and the secretary or other person aforesaid shall sign every instrument to which the seal of the company is so affixed in their presence.

DIVIDENDS AND RESERVE

77. The company in general meeting may declare dividends, but no dividend shall exceed the amount recommended by the Board.
78. Subject to the provisions of section 123, the Board may from time to time pay to the members such interim dividends as appear to it to be justified by the profits of the company.
79. i. The Board may, before recommending any dividend, set aside out of the profits of the company such sums as it thinks fit as a reserve or reserves which shall, at the discretion of the Board, be applicable for any purpose to which the profits of the company may be properly applied, including provision for meeting contingencies or for equalizing dividends; and pending such application, may, at the like discretion, either be employed in the business of the company or be invested in such investments (other than shares of the company) as the Board may, from time to time, think fit.
- ii. The Board may also carry forward any profits which it may consider necessary not to divide, without setting them aside as a reserve.
80. i. Subject to the rights of persons, if any, entitled to shares with special rights as to dividends, all dividends shall be declared and paid according to the amounts paid or credited as paid on the shares in respect whereof the dividend is paid, but if and so long as nothing is paid upon any of the shares in the company, dividends may be declared and paid according to the amounts of the shares.
- ii. No amount paid or credited as paid on a share in advance of calls shall be treated for the purposes of this regulation as paid on the share.
- iii. All dividends shall be apportioned and paid proportionately to the amounts paid or credited as paid on the shares during any portion or portions of the period in respect of which the dividend is paid; but if any share is issued on terms providing that it shall rank for dividend as from a particular date such share shall rank for dividend accordingly. That there shall be no forfeiture of unclaimed dividends before the claim becomes barred by law.
81. The Board may deduct from any dividend payable to any member all sums of money, if any, presently payable by him to the company on account of calls or otherwise in relation to the shares of the company.
82. i. Any dividend, interest or other monies payable in cash in respect of shares may be paid by cheque or warrant sent through the post directed to the registered address of the holder or, in the case of joint holders, to the registered address of that one of the joint holders who is first named on the register of members, or to such person and to such address as the holder or joint holders may in writing direct.
- ii. Every such cheque or warrant shall be made payable to the order of the person to whom it is sent.

83. Any one of two or more joint holders of a share may give effective receipts for any dividends, bonuses or other monies payable in respect of such share.
84. Notice of any dividend that may have been declared shall be given to the persons entitled to share therein in the manner mentioned in the Act.
85. No dividend shall bear interest against the company.

ACCOUNTS

86.
 - i. The Board shall from time to time determine whether and to what extent and at what times and places and under what conditions or regulations, the accounts and books of the company, or any of them, shall be open to the inspection of members not being directors.
 - ii. No member (not being a director) shall have any right of inspecting any account or book or document of the company except as conferred by law or authorised by the Board or by the company in general meeting.

WINDING UP

87. Subject to the provisions of Chapter XX of the Act and rules made thereunder-
 - i. If the company shall be wound up, the liquidator may, with the sanction of a special resolution of the company and any other sanction required by the Act, divide amongst the members, in specie or kind, the whole or any part of the assets of the company, whether they shall consist of property of the same kind or not.
 - ii. For the purpose aforesaid, the liquidator may set such value as he deems fair upon any property to be divided as aforesaid and may determine how such division shall be carried out as between the members or different classes of members.
 - iii. The liquidator may, with the like sanction, vest the whole or any part of such assets in trustees upon such trusts for the benefit of the contributories if he considers necessary, but so that no member shall be compelled to accept any shares or other securities whereon there is any liability.

INDEMNITY

88. Every officer of the company shall be indemnified out of the assets of the company against any liability incurred by him in defending any proceedings, whether civil or criminal, in which judgment is given in his favour or in which he is acquitted or in which relief is granted to him by the court or the Tribunal.

DEMATERIALISATION AND REMATERIALISATION OF SECURITIES

89.
 - i. Notwithstanding anything contained herein, the Company shall be entitled to dematerialise its shares, debentures and other securities pursuant to the Depositories Act, 1996 and to offer its shares, debentures and other securities for subscription in a dematerialised form.
 - ii. Notwithstanding anything contained herein, the Company shall be entitled to treat the person whose names appear in the register of members as a holder of shares or whose names appear as beneficial owners of shares in the records of the depository, as the absolute owner thereof and accordingly shall not (except as ordered by a Court of competent jurisdiction or as required by law) be bound to recognise any claim on or interest in such share on the part of any other person, whether or not it has express or implied notice thereof.
 - iii. Notwithstanding anything contained herein, in the case of transfer of shares or other securities where the Company has not issued any certificates and where such shares or other securities are being held in an electronic and fungible form, provisions of the Depositories Act, 1996 shall apply. Further, the provisions relating to progressive numbering shall not apply to the shares of the Company which have been dematerialised.
 - iv. Rights of depositories & beneficial owners:

- a) Notwithstanding anything to the contrary contained in the Act or these Articles, a depository shall be deemed to be the registered owner for the purposes of effecting transfer of ownership of securities on behalf of the beneficial owner.
- b) Save as otherwise provided in (a) above, the depository as the registered owner of the securities shall not have any voting rights or any other rights in respect of the Securities held by it.

SECTION IX – OTHER INFORMATION

MATERIAL CONTRACTS AND DOCUMENTS FOR INSPECTION

The following contracts (not being contracts entered into in the ordinary course of business carried on by the Company or entered into more than two years before the date of the Prospectus) which are or may be deemed material have been entered or to be entered into by the Company which are or may be deemed material will be attached to the copy of the Red Herring Prospectus, delivered to the Registrar of Companies, for filing. Copies of the abovementioned contracts and also the documents for inspection referred to hereunder, may be inspected at the Registered Office between 10 a.m. and 5 p.m. on all Working Days from the date of the Red Herring Prospectus until the Bid/ Issue Closing Date.

Material Contracts

1. Issue Agreement dated May 10, 2024 between our Company and the Book Running Lead Manager to the Issue.
2. Registrar Agreement dated May 10, 2024 executed between our Company and the Registrar to the Issue.
3. Banker to the Issue Agreement dated June 25, 2024 among our Company, Book Running Lead Manager, Banker to the Issue and the Registrar to the Issue.
4. Market Making Agreement dated June 25, 2024 between our Company, Book Running Lead Manager and Market Maker.
5. Underwriting Agreement dated June 25, 2024 between our Company, Book Running Lead Manager and Underwriter.
6. Syndicate Agreement dated June 25, 2024 among our Company, the Book Running Lead Manager and Syndicate Member.
7. Tripartite Agreement dated March 07, 2024 among CDSL, the Company and the Registrar to the Issue.
8. Tripartite Agreement dated March 11, 2024 among NDSL, the Company and the Registrar to the Issue.

Material Documents

1. Certified copies of the Memorandum and Articles of Association of the Company as amended.
2. Certificate of Incorporation dated August 04, 2022 issued by the Registrar of Companies, Central Registration Centre.
3. Certificate of Incorporation pursuant to change of name from “Sunlite Alucop Private Limited” to “Sunlite Recycling Industries Private Limited” dated January 18, 2024 issued by the Registrar of Companies, Ahmedabad.
4. Fresh Certificate of Incorporation Consequent upon Conversion from Private Company to Public Company dated April 30, 2024 issued by the Registrar of Companies, Central Processing Centre, consequent upon change of Name of the company form “Sunlite Recycling Industries Private Limited” to “Sunlite Recycling Industries Limited”.
5. Copy of the Board Resolution dated May 01, 2024 authorizing the Issue and other related matters.
6. Copy of Shareholder’s Resolution dated May 06, 2024 authorizing the Issue and other related matters.
7. Copies of Audited Financial Statements of our Company for the financial year ended March 31, 2024 and March 31, 2023.
8. Statutory Auditors Report dated July 20, 2024 on the Restated Financial Statements for the financial years ended March 31, 2024, March 31, 2023 and March 31, 2022.
9. Copy of the Statement of Special Tax Benefits dated May 08, 2024 from the Statutory auditor.
10. Certificate on Key Performance Indicators (KPI’s) issued by Statutory Auditor dated July 20, 2024.
11. Consents of the Book Running Lead Manager to the Issue, Legal Advisor to the Issue, Registrar to the Issue, Market Maker, Syndicate Member, Underwriter, Banker to the Issue/ Sponsor Bank, Statutory Auditor of the Company, Bankers to our Company, Directors, Promoters, Company Secretary and Compliance Officer and Chief Financial Officer, as referred to, in their respective capacities.
12. Board Resolution dated May 21, 2024 for approval of Draft Red Herring Prospectus and dated August 05, 2024 for approval of Red Herring Prospectus and dated August 16, 2024 for approval of Prospectus.
13. Due Diligence Certificate from Book Running Lead Manager dated May 21, 2024.
14. Approval from NSE vide letter dated July 29, 2024 to use the name of NSE in the Prospectus for listing of Equity Shares on the NSE Emerge (SME Platform) of the National Stock Exchange of India Limited.

DECLARATION

I certify and declare that all relevant provisions of the Companies Act, 2013 and the rules, regulations and guidelines issued by the Government of India or the regulations or guidelines issued by SEBI, established under section 3 of the Securities and Exchange Board of India Act, 1992, as the case may be, have been complied with and no statement made in this Prospectus is contrary to the provisions of the Companies Act, the Securities Contracts (Regulation) Act, 1956, as amended, the Securities and Exchange Board of India Act, 1992, as amended or the rules, regulations or guidelines issued thereunder, as the case may be. I further certify that all the statements in this Prospectus are true and correct.

SIGNED BY THE BOARD OF DIRECTORS OF OUR COMPANY:

Name and Designation	Signature
Nitin Kumar Heda Managing Director DIN: 00383855	Sd/-

Date: August 16, 2024

Place: Kheda, Gujarat

DECLARATION

I certify and declare that all relevant provisions of the Companies Act, 2013 and the rules, regulations and guidelines issued by the Government of India or the regulations or guidelines issued by SEBI, established under section 3 of the Securities and Exchange Board of India Act, 1992, as the case may be, have been complied with and no statement made in this Prospectus is contrary to the provisions of the Companies Act, the Securities Contracts (Regulation) Act, 1956, as amended, the Securities and Exchange Board of India Act, 1992, as amended or the rules, regulations or guidelines issued thereunder, as the case may be. I further certify that all the statements in this Prospectus are true and correct.

SIGNED BY THE BOARD OF DIRECTORS OF OUR COMPANY:

Name and Designation	Signature
Prahladrai Ramdayal Heda Chairman & Whole Time Director DIN: 09696242	Sd/-

Date: August 16, 2024

Place: Kheda, Gujarat

DECLARATION

I certify and declare that all relevant provisions of the Companies Act, 2013 and the rules, regulations and guidelines issued by the Government of India or the regulations or guidelines issued by SEBI, established under section 3 of the Securities and Exchange Board of India Act, 1992, as the case may be, have been complied with and no statement made in this Prospectus is contrary to the provisions of the Companies Act, the Securities Contracts (Regulation) Act, 1956, as amended, the Securities and Exchange Board of India Act, 1992, as amended or the rules, regulations or guidelines issued thereunder, as the case may be. I further certify that all the statements in this Prospectus are true and correct.

SIGNED BY THE BOARD OF DIRECTORS OF OUR COMPANY:

Name and Designation	Signature
Khushboo Manishkumar Heda Non-Executive Director DIN: 09696263	Sd/-

Date: August 16, 2024

Place: Kheda, Gujarat

DECLARATION

I certify and declare that all relevant provisions of the Companies Act, 2013 and the rules, regulations and guidelines issued by the Government of India or the regulations or guidelines issued by SEBI, established under section 3 of the Securities and Exchange Board of India Act, 1992, as the case may be, have been complied with and no statement made in this Prospectus is contrary to the provisions of the Companies Act, the Securities Contracts (Regulation) Act, 1956, as amended, the Securities and Exchange Board of India Act, 1992, as amended or the rules, regulations or guidelines issued thereunder, as the case may be. I further certify that all the statements in this Prospectus are true and correct.

SIGNED BY THE BOARD OF DIRECTORS OF OUR COMPANY:

Name and Designation	Signature
Ronak Ashokbhai Mehta Independent Director DIN: 10525257	Sd/-

Date: August 16, 2024

Place: Kheda, Gujarat

DECLARATION

I certify and declare that all relevant provisions of the Companies Act, 2013 and the rules, regulations and guidelines issued by the Government of India or the regulations or guidelines issued by SEBI, established under section 3 of the Securities and Exchange Board of India Act, 1992, as the case may be, have been complied with and no statement made in this Prospectus is contrary to the provisions of the Companies Act, the Securities Contracts (Regulation) Act, 1956, as amended, the Securities and Exchange Board of India Act, 1992, as amended or the rules, regulations or guidelines issued thereunder, as the case may be. I further certify that all the statements in this Prospectus are true and correct.

SIGNED BY THE BOARD OF DIRECTORS OF OUR COMPANY:

Name and Designation	Signature
Jaimish Govindbhai Patel Independent Director DIN: 09647742	Sd/-

Date: August 16, 2024

Place: Kheda, Gujarat

DECLARATION

I certify and declare that all relevant provisions of the Companies Act, 2013 and the rules, regulations and guidelines issued by the Government of India or the regulations or guidelines issued by SEBI, established under section 3 of the Securities and Exchange Board of India Act, 1992, as the case may be, have been complied with and no statement made in this Prospectus is contrary to the provisions of the Companies Act, the Securities Contracts (Regulation) Act, 1956, as amended, the Securities and Exchange Board of India Act, 1992, as amended or the rules, regulations or guidelines issued thereunder, as the case may be. I further certify that all the statements in this Prospectus are true and correct.

SIGNED BY THE CHIEF FINANCIAL OFFICER OF OUR COMPANY:

Name and Designation	Signature
Manish Kumar Heda Chief Financial Officer PAN: ACEPH9256R	Sd/-

Date: August 16, 2024

Place: Kheda, Gujarat

DECLARATION

I certify and declare that all relevant provisions of the Companies Act, 2013 and the rules, regulations and guidelines issued by the Government of India or the regulations or guidelines issued by SEBI, established under section 3 of the Securities and Exchange Board of India Act, 1992, as the case may be, have been complied with and no statement made in this Prospectus is contrary to the provisions of the Companies Act, the Securities Contracts (Regulation) Act, 1956, as amended, the Securities and Exchange Board of India Act, 1992, as amended or the rules, regulations or guidelines issued thereunder, as the case may be. I further certify that all the statements in this Prospectus are true and correct.

SIGNED BY THE COMPANY SECRETARY OF OUR COMPANY:

Name and Designation	Signature
Nikita Sharma Company Secretary & Compliance officer M. No.: A50255	Sd/-

Date: August 16, 2024

Place: Kheda, Gujarat